

PANZERI

Hilow

24V DC 24V
A029U19.115.4610

 mat brass



Spec sheet

CODE	A029U19.115.4610
SYSTEM POWER CONSUMPTION	71W
EFFICACY	57.58lm/W
LIGHT SOURCE	LED
LIGHT SOURCE LIFETIME	L70 (B10) 60.000h
COLOUR TEMPERATURE	3500K Ra>90
LIGHT DISTRIBUTION	diffused
POWER SUPPLY	24V DC
ELECTRICAL CONFIGURATION	24V
DRIVER	remote not included
NOMINAL LUMINOUS FLUX	8568lm
DELIVERED LUMEN OUTPUT	4088lm
EFFICIENCY	47.7%
WEIGHT	4,74 lbs
PROTECTION DEGREE	IP20
COLOUR TOLLERANCES	SDCM 3
PACKING DIMENSIONS	34,3 x 46,5 x 5,5 in



Wall lighting fixture for interiors, with direct and indirect light emission.
Pickled sheet metal wall bracket in polyacrylic paint.
Pickled sheet metal wall plate in polyacrylic paint.
Extruded aluminium structure in white, mat black, bronze, mat brass or titanium polyacrylic paint.
Joints in turned brass and die-cast aluminium in polyacrylic paint.
Die-cast aluminium end caps in polyacrylic paint.
Extruded polycarbonate diffusers with black finish for direct light emission and opaline finish for indirect light emission.

Technical drawing

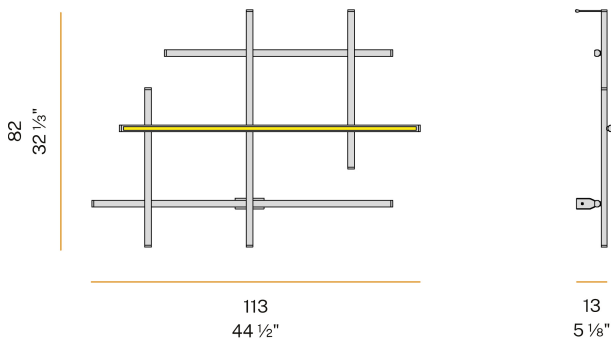

Polar diagram

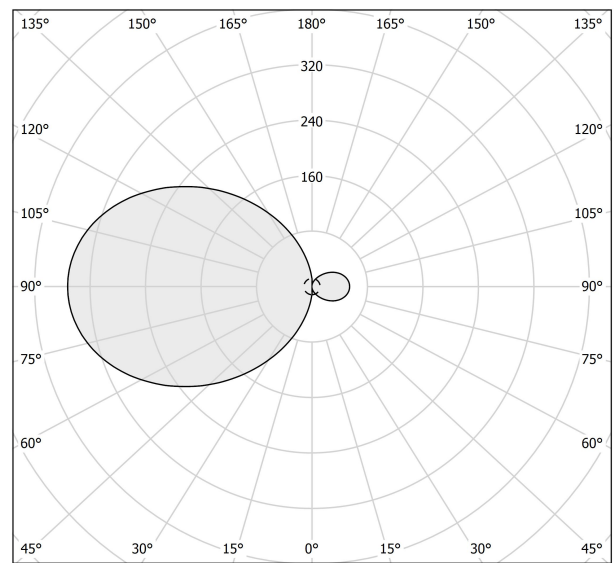

cd/klm
— C0 - C180 - - - C90 - C270