

PANZERI

Hilow

120V AC dimmable (0-10V)

L029U19.115.4653

 mat brass



Spec sheet

CODE	L029U19.115.4653
SYSTEM POWER CONSUMPTION	80W
EFFICACY	26.48lm/W
LIGHT SOURCE	LED
LIGHT SOURCE LIFETIME	L70 (B10) 60.000h
COLOUR TEMPERATURE	3500K Ra>90
LIGHT DISTRIBUTION	diffused
POWER SUPPLY	120V AC
FREQUENCY	50/60Hz
ELECTRICAL CONFIGURATION	dimmable (0-10V)
DRIVER	integrated included
NOMINAL LUMINOUS FLUX	9072lm
DELIVERED LUMEN OUTPUT	2118lm
EFFICIENCY	23.3%
WEIGHT	6,17 lbs
PROTECTION DEGREE	IP20
COLOUR TOLLERANCES	SDCM 3
PACKING DIMENSIONS	34,3 x 46,5 x 5,5 in



Pendant lighting fixture for interiors, with direct and indirect light emission.
Extruded aluminium structure in white, mat black, bronze, mat brass or titanium polyacrylic paint.
Joints in turned brass and die-cast aluminium in polyacrylic paint.
Die-

Technical drawing

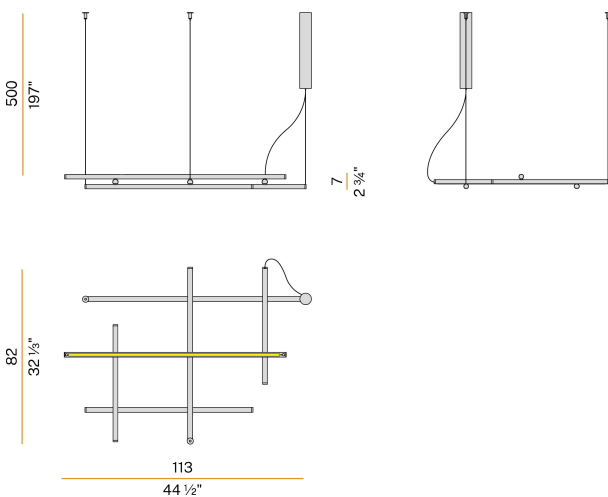

Polar diagram

