

# PANZERI

## Zero Square

24V DC 24V

M152U30.050.0410

titanium



### Spec sheet

CODE	M152U30.050.0410
SYSTEM POWER CONSUMPTION	25W
EFFICACY	81.56lm/W
LIGHT SOURCE	LED
LIGHT SOURCE LIFETIME	L70 (B50) 60.000h
COLOUR TEMPERATURE	3000K Ra>90
LIGHT DISTRIBUTION	diffused
POWER SUPPLY	24V DC
ELECTRICAL CONFIGURATION	24V
DRIVER	remote not included
NOMINAL LUMINOUS FLUX	2835lm
DELIVERED LUMEN OUTPUT	2039lm
EFFICIENCY	71.9%
WEIGHT	2,03 lbs
PROTECTION DEGREE	IP20
COLOUR TOLLERANCES	SDCM 3
PACKING DIMENSIONS	22,8 x 22,8 x 3,9 in



Single or multiple pendant lighting fixture for interiors, with direct and indirect light emission.

Bended extruded aluminium structure in white, black, bronze, mat brass or titanium polyacrylic paint.

Extruded polycarbonate diffuser with opaline finish



### Technical drawing

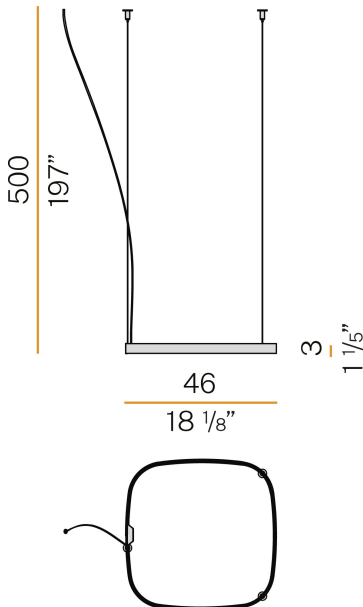

### Polar diagram

