

PANZERI

Zero Round

120-277V AC dimmable (0-10V)

P153U02.075.4653



Spec sheet

CODE	P153U02.075.4653
SYSTEM POWER CONSUMPTION	42W
EFFICACY	72.83lm/W
LIGHT SOURCE	LED
LIGHT SOURCE LIFETIME	L70 (B50) 60.000h
COLOUR TEMPERATURE	3500K Ra>90
LIGHT DISTRIBUTION	diffused
POWER SUPPLY	120-277V AC
FREQUENCY	60Hz
ELECTRICAL CONFIGURATION	dimmable (0-10V)
DRIVER	integrated included
NOMINAL LUMINOUS FLUX	4252lm
DELIVERED LUMEN OUTPUT	3059lm
EFFICIENCY	71.9%
WEIGHT	3,97 lbs
PROTECTION DEGREE	IP20
COLOUR TOLLERANCES	SDCM 3
PACKING DIMENSIONS	32,7 x 32,7 x 3,9 in

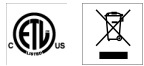

Ceiling or wall lighting fixture for interiors, with direct and indirect light emission.
 Pickled sheet metal ceiling or wall bracket in polyacrylic paint.
 Pickled sheet metal wall plate in polyacrylic paint.
 Bended extruded aluminium structure in white, black, bronze, mat brass or titanium polyacrylic paint.
 Extruded polycarbonate diffuser with opaline finish.

Technical drawing

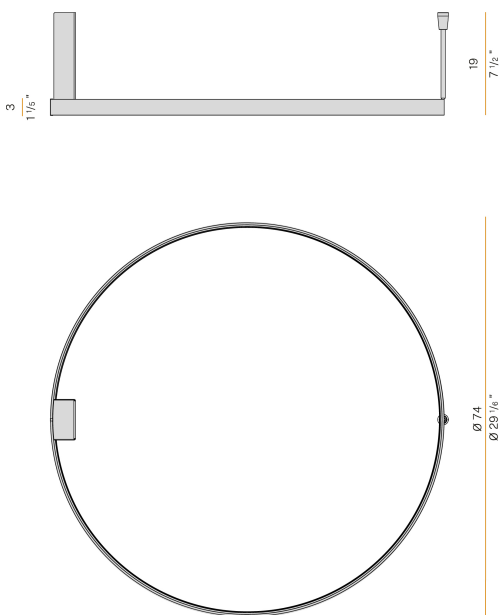

Application



Polar diagram

