



PANZERI[®]
WE MAKE LIGHT

PANZERI®
WE MAKE LIGHT

2019



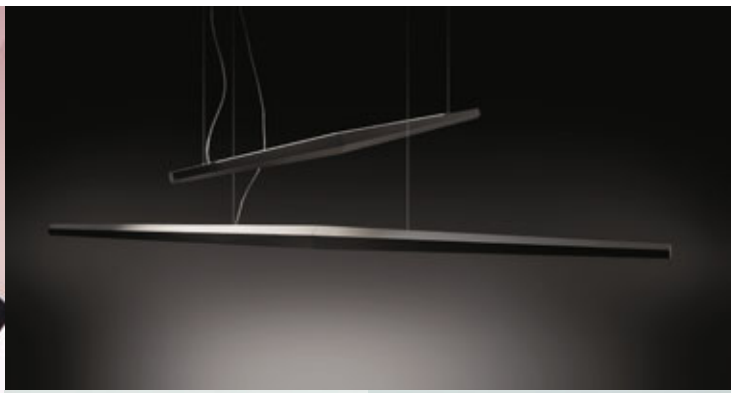

DESIGN	19
ACOUSTIC	92
ROSONI E DECENTRAMENTI	352
OUTDOOR	363
PROFILI	391
INVISIBILI/INCASSI	489
ELECTRIC OPTIONS	518
TECHNICAL INFORMATION	526



Una storia tutta italiana quella raccontata dalla compagine di eventi che ha portato la nostra azienda ad affermarsi come una delle più rappresentative nel panorama dell'illuminazione. Tutto ebbe inizio nel 1947 quando Carlo Panzeri, navigato imprenditore nel settore metalmeccanico, fonda una piccola azienda specializzata in componentistica per lampadari. Passione e competenza hanno determinato la crescita costante, che negli anni '90 ci ha portato ad avviare con successo la produzione della prima linea di prodotti Panzeri. Coniugando il patrimonio di tradizione e artigianalità ereditato con un contenuto tecnologico di altissimo livello, siamo sempre rimasti fedeli a quei valori che rappresentano al meglio la nostra filosofia: qualità, ricerca e innovazione. Dalla piccola realtà degli inizi, oggi Panzeri è una fabbrica all'avanguardia che segue un modello di produzione sostenibile. Attrezzature e macchinari di ultima generazione ci consentono di eseguire in sede più dell'80% delle lavorazioni e di offrire soluzioni particolareggiate per ogni specifica esigenza. "We make light" rappresenta il nostro essere una famiglia che tramanda con amore il saper fare luce a regola d'arte da generazioni. Oggi come allora lo facciamo nel pieno rispetto della tradizione Made in Italy, affidandoci a fornitori italiani per l'approvvigionamento di materie prime selezionate e al genio creativo di chi, come noi, orienta il proprio lavoro alla realizzazione di prodotti di design unici.

An Italian story the one told by events that has led our company to establish as one of the most representative in the lighting scene. It all began in 1947 when Carlo Panzeri, a skilled businessman in the engineering sector, founded a small company specialized in components for lighting fixtures. Passion and competence have brought us to steady growth, which in the 90s led us to successfully start the production of the first Panzeri product line. Combining the heritage of tradition and craftsmanship inherited with a high-level technological content, we have always been faithful to those values that best represent our philosophy: quality, research and innovation. From the small reality of the beginning, Panzeri is today a cutting-edge factory that follows a sustainable production model. Latest generation equipment and machinery allow us to perform more than 80% of the work on site and to offer detailed solutions for every specific need. "We make light" represents our being a family that hands down for generations the know how to make light to state-of-the-art standards. Today, as in the past, we do it according to the Made in Italy tradition, relying on Italian suppliers for the procurement of selected raw materials and the creative genius of those who, just like us, work for making unique design products.



**WE
MAKE
LIGHT**

We, è uno dei valori più importanti che rappresenta la familiarità e l'artigianalità ereditata in 70 anni di storia. Una storia che è stata vissuta e raccontata da imprenditori innamorati del proprio lavoro che con forza e coraggio hanno anticipando tempi e tendenze.

We, is one of the most important values that represents the family origins and craftsmanship inherited in 70 years of history. A story that was lived and recounted by entrepreneurs in love with their work who, with strength and courage, had the ability to anticipate times and trends.

Make, inteso come l'arte del saper fare, inizia con la ricerca delle materie prime selezionate con accuratezza e precisione determinando la massima qualità per un prodotto ottimo. Le lampade sono realizzate con cura e attenzione, progettate per illuminare e impreziosire spazi interni ed esterni.

Make, understood as the art of know-how, starting with the research of selected raw materials with extreme accuracy and precision so determining the maximum quality for an excellent product. The lamps are made with care and attention, designed to enlighten and enrich both the interior and exterior spaces.

Light, una fabbrica moderna, che offre ai propri clienti la soluzione per ogni esigenza, oltre al design italiano sviluppato dall'azienda e apprezzato in tutto il mondo, le lampade Panzeri sono considerate componenti di arredo e soluzioni di illuminazione.

Light, a modern company, which offers its customers the right solution for every need, in addition to the Italian design developed by the company and appreciated worldwide, the lamps by Panzeri are considered decorating items and lighting solutions.

DESIGN



Agave
P 324



AlDecimo
P 142



App
P 250



Bella
P 20
NOVELTY



Blanca
P 272



Brooklyn Line
P 156



Brooklyn Round
P 148

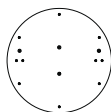

Rosone per Brooklyn Round
P 154
NOVELTY



Candle
P 286



Carmen Carmencita
P 282



Classic
P 346



Cross
P 320



Disco
P 344



Domino
P 300



Elle
P 342



Ely Emy Evy
P 98
NOVELTY



Firefly in the sky
P 48
NOVELTY



Flat
P 276



Floral
P 330



Giano
P 162



Gilbert
P 294



Ginevra
P 114



Golden Ring
P 202



Gong
P 104



Jackie
P 188



Jackie IOT
P 196



Jazz
P 290



Kubik
P 254



Line
P 306



Olivia, Emma&Clio
P 178



One
P 224



Planet Ring
P 218



Silver Ring
P 210



Smoke
P 122



Tate
P 358



Three
P 236



To-be
P 170



Toy / Toy Gypso
P 240 / 244



Tubino
P 36
NOVELTY



Twister
P 336



Two
P 230



Viisi
P 134



Viki
P 340



Willy Alu
P 268



Willy Glass
P 264



Willy XL
P 260



Ypsilon
P 316



Zero
P 310



Zero Ellipse
P 62
NOVELTY



Zero Round
P 72



Zero Round Vertical
P 72
NOVELTY



Zero Square
P 66
NOVELTY

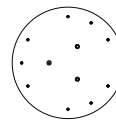

Rosoni per
Zero Shapes
P 88
NOVELTY

ACOUSTIC



Zig Zag
P 92
NOVELTY



**ROSONI E
DECENTRAMENTI**
P 352
NOVELTY

OUTDOOR



Box
P 380



Draco
P 384



Firefly in the sky
P 48
NOVELTY



Four
P 376



Lampyris
P 372



Potter
P 389



Ralph
P 364

TIPOLOGIE DI INSTALLAZIONE / MOUNTING TYPES

	SOSPENSIONE SUSPENSION	PARETE WALL	SOFFITTO CEILING	TAVOLO TABLE	TERRA FLOOR	BINARIO TRACK
DESIGN						
AGAVE	•		•			
AL DECIMO		•				
APP		•				
BELLA	•	•		•		
BROOKLYN LINE	•					
BROOKLYN ROUND	•	•	•			
BLANCA	•					
CANDLE	•					•
CARMEN		•	•			
CARMENCITA		•				
CLASSIC		•		•	•	
CLIO	•					•
CROSS		•				
DISCO		•	•			
DOMINO	•	•	•			
ELLE		•	•			
ELY	•					•
EMMA	•					•
EMY	•					•
EVY	•					•
FIREFLY in the sky				•	•	
FLAT	•	•	•			
FLORAL	•			•	•	
GIANO	•	•				
GILBERT	•		•	•		•
GINEVRA	•	•	•			
GOLDEN RING	•					
GONG	•					
JACKIE		•	•	•	•	•
JACKIE IOT		•	•	•	•	•
JAZZ	•					•
KUBIK	•	•	•	•		
LINE	•				•	•
OLIVIA	•					•
ONE	•		•			•
PLANET RING	•	•	•			
SILVER RING	•	•	•			
SMOKE	•					•
TATE	•	•				
THREE		•	•			
TO-BE	•		•			
TOY/TOY GYPSO		•				
TUBINO		•	•	•	•	
TWISTER	•	•		•	•	
TWO	•		•			•
VIISI	•				•	
VIKI	•	•	•			
WILLY GLASS	•					•
WILLY ALU	•					•
WILLY XL	•					•
YPSILON		•				
ZERO		•	•			
ZERO ELLIPSE	•					
ZERO ROUND	•	•				
ZERO SQUARE	•					
ACOUSTIC						
ZIG ZAG	•					
OUTDOOR						
BOX		•	•			
DRACO		•				
FIREFLY in the sky				•	•	
FOUR		•	•			
LAMPyris					•	
POTTER					•	
RALPH	•	•		•	•	

PROFILI



Broadway
P 444



Bronx
P 416

NOVELTY



Brooklyn
P 430



Brooklyn Round
P 424



Brooklyn Spot
P 436

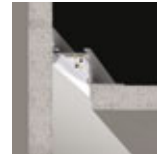

Corner
P 476



Giano
P 482



Jackie spot
P 400



Manhattan
P 466



Nolita
P 446



Queens
P 398



Queens Compact
P 401



Queens mini
P 402



Queens spot
P 403



Soho in
P 392

NOVELTY



Soho out
P 393

NOVELTY



Soho spot micro
P 397

NOVELTY



Soho spot micro low
P 396

NOVELTY



Soho spot nano
P 395

NOVELTY



Tribeca
P 442

INVISIBILI



CLICK CLACK
P 494

NOVELTY



XGQ0998
P 496



XGQ0998GL
P 497



XGQ0999
P 498



XGQ1000-1
P 498



XGQ1004
P 499



XGQ1004-45
P 500



XGQ1004-GL
P 499



XGQ1015
P 500



XGQ1019
P 501



XGQ1025
P 504



XGQ1026
P 504



XGQ1031
P 505



XGQ1032
P 507



XGQ1034-1
P 506



XGQ1034-2
P 506



XGQ1034-3
P 507



XGQ1210
P 508



XGQ1211
P 509



XGR0997
P 496



XGR1020
P 501

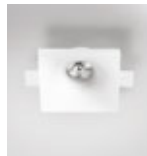

XGR1021
P 502



XGR1023
P 503



XGR1024
P 503



XGR1027
P 505

INCASSI



QUEENS IN 60
P 511



QUEENS IN 50
IP65
P 512
NOVELTY



QUEENS IN 40
P 513
NOVELTY

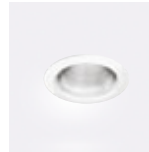

ROY
P 514



XA2115
P 515



XA2116
P 515



XA2117
P 516



XSV2008
P 514

ELECTRIC OPTIONS



P 518

TECHNICAL INFORMATION

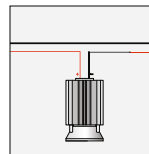

P 526

SISTEMA DI CODIFICA CODE SYSTEM

Esempi / Examples

XG 231 01 . 360 . 00 99	Profilo da incasso Brooklyn round 100 360° No led No alimentazione Recessed track Brooklyn round 100 White 360° No led No electricity
A 016 37 . 025 . 01 01	Lampada da parete Toy Acciaio inox lucido 25 cm Led 3000K Ra80 Alimentazione standard Wall lamp Toy Polished stainless steel 25 cm 3000K Ra80 Standard power supply
C 077 03 . 000 . 04 13	Lampada da tavolo Jackie Rossa Led 3000K Ra90 IoT step dim Table lamp Jackie Red 3000K Ra90 IoT step dim
L 081 21 . 180 . 01 02	Sospensione Golden Ring Foglia oro diametro 180 cm Led 3000K Ra80 DALI / PUSH DIM Suspension Golden Ring gold leaf diameter 180 3000K Ra80 DALI / PUSH DIM

Attacco	Legenda	Finiture diffusori	Legenda	K/Ra °	Legenda	Elettrificazione	Legenda
Type of mounting	Legend	Colour finish diffuser	Legend	K/Ra °	Legend	Electricity	Legend
A	parete / wall	00	nessuna / unfinished	00		00	standard / standard
CA	parete-mensola / wall bracket	01	bianco / white	01	3000/80	01	alimentazione standard standard power supply
P	soffitto / ceiling	02	nero / black	02	2700/80	02	alimentazione DALI / PUSH DIM DALI / PUSH DIM power supply
C	tavolo / table	03	rosso / red	03	4000/80	03	alimentazione 1-10V / Push DIM 1-10V / PUSH DIM power supply
CM	tavolo morsetto / table clamp	04	nero gommato / rubber black	04	3000/90	04	taglio di fase / phase cut
CP	tavolo perno / table bolt down	05	champagne / champagne	05	2700/90	05	RGB / RGB
L	sospensione / suspension	06	nero satinato / mat black	06	4000/90	06	LED tensione di rete / 220V LED
M	sospensione senza rosone suspension without canopy	10	bianco lucido / glossy white	11	2700/80/NS	07	emergenza / emergency
T	terra / floor	12	grigio metallizzato- paralume bianco metallized grey-white shade	12	2700/80/S	08	mono standard / mono standard
EA	esterni parete / exterior wall	13	grigio metallizzato- paralume plissé / metallized grey-plissé shade	13	2700/80/FL	09	Step DIM / Step DIM
EP	esterni soffitto / exterior ceiling	14	marrone metallizzato- paralume bianco/metallized brown-white shade	14	2700/80/WFL	10	24 Volt / 24 Volt
EC	esterno tavolo / exterior table	15	marrone metallizzato- paralume plissé/metallized brown-plissé shade	15	2700/90/NS	11	12 Volt / 12 Volt
EL	esterno sospensione exterior suspension	17	bronzo / bronze	16	2700/90/S	12	alimentazione bilevel/bilevel driver
ET	esterno terra / exterior floor	18	rame satinato / mat copper	17	2700/90/FL	13	IoT-Step DIM / IoT-Step DIM
PE	esterno terra picchetto exterior floor peg	19	ottone satinato / mat brass	18	2700/90/WFL	14	batteria / battery
X	incassi / recessed downlight	20	ottone lucido / polished brass	19	3000/80/NS	15	corrente costante/constant current
XGQ	incassitrimesse quadro recessed trimless squared	21	foglia oro / gold leaf	20	3000/80/S	16	48 Volt / 48 Volt
XGR	invisibili trimesse tondo recessed trimless round	22	cromo / chrome	21	3000/80/FL	17	bianco dinamico/tunable white
XG	sistema da incasso recessed linear system	23	foglia argento / silver leaf	22	3000/80/WFL	99	no elettrificazione / no electricity
XP	sistema sosp-soffitto-parete suspension-ceiling-wall system	24	foglia rame / copper leaf	23	3000/90/NS		
XM	accessori / accessory	25	rame lucido / polished copper	24	3000/90/S		
B	attacco a binario / electrical adapter	30	titanio / titanium	25	3000/90/FL		
		31	grigio metallizzato-diffusore nero / metallized grey-black diffuser	26	3000/90/WFL		
		32	nicel / nickel	27	4000/90/NS		
		33	grigio metallizzato-diffusore bianco / metallized grey/white diffuser	28	4000/90/S		
		34	grigio micaceo / micaceous grey	29	4000/90/FL		
		35	alluminio sabbaiato / sanded aluminum	30	4000/90/WFL		
		36	anodizzato naturale / natural anodized				
		37	acciaio inox lucido / polished stainless steel				
		38	grigio metallizzato / diffusori bianco-nero metallized grey / white-black diffusers				
		39	acciaio inox satinato / mat stainless steel				
		40	titanio-diffusore fumé / titanium-smoky grey diffuser				
		41	titanio-diffusore bianco / titanium-white diffuser				
		42	gesso / plaster				
		44	marrone metallizzato / metallized brown				
		46	bianco-policarbonato opale / white-opal polycarbonate				
		47	bianco-policarbonato prismato / white-micropismatic polycarbonate				
		48	nero-policarbonato opale / black-opal polycarbonate				
		49	nero-policarbonato prismato / black-micropismatic polycarbonate				
		50	metal-silver / metal-silver				
		51	nero-diffusore bianco / black-white diffuser				
		52	nero-diffusore cristallo / black-crystal diffuser				
		53	nero-diffusore acciaio / black-steel diffuser				
		54	nero-diffusore ambra / black-amber diffuser				
		55	nero-diffusore bronzo / black-bronze diffuser				
		56	nero-diffusore tabacco / black-tobacco diffuser				
		57	nero-diffusore verde / black-green diffuser				
		61	rame lucido-diffusore / bianco polished copper-white diffuser				
		62	rame lucido-diffusore cristallo / polished copper-crystal diffuser				
		63	rame lucido-diffusore acciaio / polished copper-steel diffuser				
		64	rame lucido-diffusore ambra / polished copper-amber diffuser				
		65	rame lucido-diffusore bronzo / polished copper-bronze diffuser				
		66	rame lucido-diffusore tabacco / polished copper-tobacco diffuser				
		67	rame lucido-diffusore verde / polished copper-green diffuser				
		71	ottone satinato-diffusore bianco / mat brass-white diffuser				
		72	ottone satinato-diffusore cristallo / mat brass-crystal diffuser				
		73	ottone satinato-diffusore acciaio / mat brass-steel diffuser				
		74	ottone satinato-diffusore ambra / mat brass-amber diffuser				
		75	ottone satinato-diffusore bronzo / mat brass-bronze diffuser				
		76	ottone satinato-diffusore tabacco / mat brass-tobacco diffuser				
		77	ottone satinato-diffusore verde / mat brass-green diffuser				
		80	nero satinato-oro / mat black-gold				
		81	bianco-oro / white-gold				

INDEX

Page	Code	Collection	Page	Code	Collection
330	013	Floral	162	246	Giano
122	015	Smoke	515	XA2115	Joe
240	016	Toy	515	XA2116	Joe Q
134	020 - 021	Viisi	516	XA2117	Joe Twist
142	022	AlDecimo	424	XG231 - XG232	Brooklyn Round
346	024	Classic	416	XG247	Bronx
170	025 - 026 - 027	To-be	430	XG2033	Brooklyn
324	030	Agave	430	XG2034	Brooklyn Trim
62	031	Zero Ellipse	446	XG2038	Nolita
66	032	Zero Square	446	XG2039	Nolita Trim
72	034	Zero Round Vertical	442	XG2047	Tribeca
72	033	Zero Round	466	XG2044	Manhattan
310	035	Zero	476	XG2045	Corner
306	036	Line	496	XGQ0998	Invisibili
224	037	One	497	XGQ0998GL	Invisibili
230	038	Two	498	XGQ0999	Invisibili
236	039	Three	498	XGQ1000-1	Invisibili
340	041	Viki	499	XGQ1004	Invisibili
388	042	Potter	499	XGQ1004-GL	Invisibili
92	043	Zig Zag	500	XGQ1004-45	Invisibili
376	044	Four	500	XGQ1015	Invisibili
364	047	Ralph	501	XGQ1019	Invisibili
320	049	Cross	504	XGQ1025	Invisibili
342	050 - 051	Elle	504	XGQ1026	Invisibili
20	052 - 053	Bella	505	XGQ1031	Invisibili
384	054	Draco	507	XGQ1032	Invisibili
272	057	Blanca	506	XGQ1034-1	Invisibili
282	064	Carmen - Carmencita	506	XGQ1034-2	Invisibili
294	065	Gilbert	507	XGQ1034-3	Invisibili
240	066	Disco	508	XGQ1210	Invisibili
336	067	Twister	509	XGQ1211	Invisibili
254	070	Kubik	496	XGR0997	Invisibili
316	072	Ypsilon	501	XGR1020	Invisibili
36	073	Tubino	502	XGR1021	Invisibili
276	075	Flat	503	XGR1023	Invisibili
258	076	Willy XL - Glass - Alu	503	XGR1024	Invisibili
188	077	Jackie - Jackie IOT	505	XGR1027	Invisibili
400	077	Jackie Spot	494	XGR1212	Click Clack
48	078	Firefly in the sky	436	XM2033 Spot	Brooklyn Spot
372	080	Lampyris	392-393	XM445 - XM446	Soho Track
202	081	Golden Ring	395	B752	Soho Spot Nano
210	082	Silver Ring	396	B753	Soho Spot Micro Low
218	083	Planet Ring	397	B754	Soho Spot Micro
290	089	Jazz	398	XM75 - XM76	Queens track
300	090	Domino	352		Rosoni e decentr.
176	091	Emma	403	XM742 - XM743	Queens Spot
114	092	Ginevra	402	XM748	Queens Mini
104	093	Gong	401	XM751	Queens Compact
176	094	Clio	482	XP246	Giano
288	095	Candle	430	XP2033	Brooklyn Out
176	097	Olivia	446	XP2038	Nolita Out
250	098	App	444	XP2048	Broadway
98	100	Ely	513	XR254	Queens In 40
98	101	Emy	512	XR225	Queens In 50 IP65
98	102	Evy	514	XR255	Roy
380	144	Box	511	XR262	Queens In 60
148	231 - 232	Brooklyn Round	514	XSV2008	Incasso in vetro
156	233	Brooklyn Line	358	Y-TATE	Tate

DIMENSIONI ESPRESSE NELLA TABELLA TECNICA
DIMENSIONS GIVEN IN THE SPECIFICATIONS TABLE

Sospensione
Suspension

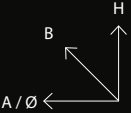
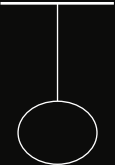

Tavolo / Table
Terra / Floor

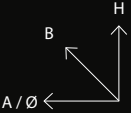
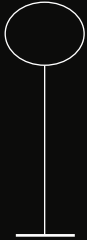

Soffitto / Ceiling
Parete / Wall

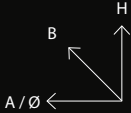

Parete / Wall

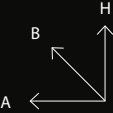

DESIGN

BELLA

Enzo Panzeri 2019

L'attento studio di miniaturizzazione della tecnologia è la chiave della straordinaria compattezza di Bella.

Braccio conico decentrato, testa orientabile e comando STEP DIM a 5 regolazioni di intensità luminosa caratterizzano le versioni da tavolo e parete, quest'ultima con snodo anche alla base, per una maggiore flessibilità nel posizionamento. La versione a sospensione, testa fissa e con tige centrale, si presta ad originali composizioni in cui elementi che diffondono luce diretta si alternano a quelli ad emissione indiretta. Tanto piccola quanto performante, Bella è un disco di luce dal carattere contemporaneo, che offre alto rendimento in minimo spazio. Bianco, nero, titanio, bronzo e ottone satinato le finiture disponibili.

The careful study of miniaturization of the technology is the key to Bella's extraordinary compactness. Decentralized conical arm, adjustable head and technology STEP DIM with 5 intensity of light settings characterize the table and wall versions, the latter also with a joint at the base, for a higher positioning flexibility. The suspension version has a fixed head with central tige, it lends to original compositions in which elements that diffuse direct light alternate with those with indirect emission. As small as performing, Bella is a contemporary disc of light which offers high performance in minimum space. White, black, titanium, bronze and mat brass finishes are available.







JW Marriott Venice Resort & Spa (IT)





























ROSONI E DECENTRAMENTI A PAGINA 352 / OFFSET AND CANOPIES PAGE 352

BELLA		Enzo Panzeri 2019	Registered Design				LED CE IP20 ( Table /  Suspension no canopy) IP40 Suspension
	CODICE / CODE	CM Ø	H	INCHES Ø	H	FONTI LUMINOSE / LIGHT SOURCES	
Sospensione / Suspension	L052_011.0201	10,1	14	4"	5 ½"	Potenza assorbita apparecchio / Luminaire power consumption 6,5W Flusso luminoso apparecchio / Luminaire luminous flux 467lm 2700K Ra80 220-240V	
	 Direct light	Cable lenght 300/118 ½"					
	L053_011.0201	10,1	14	4"	5 ½"	Potenza assorbita apparecchio / Luminaire power consumption 6,5W Flusso luminoso apparecchio / Luminaire luminous flux 467lm 2700K Ra80 220-240V	
	 Indirect light	Cable lenght 300/118 ½"					
Sospensione no rosone / no driver Suspension no canopy / no driver	M052_011.0201	10,1	14	4"	5 ½"	Potenza assorbita apparecchio / Luminaire power consumption 4,5W Flusso luminoso apparecchio / Luminaire luminous flux 467lm 2700K Ra80 24V DC	
	 Direct light	Cable lenght 300/118 ½"					
	M053_011.0201	10,1	14	4"	5 ½"	Potenza assorbita apparecchio / Luminaire power consumption 4,5W Flusso luminoso apparecchio / Luminaire luminous flux 467lm 2700K Ra80 24V DC	
	 Indirect light	Cable lenght 300/118 ½"					
Parete incasso Wall recessed	X052_011.0209	10,1	9,4	4"	3 ¾"	Potenza assorbita apparecchio / Luminaire power consumption 5W Flusso luminoso apparecchio / Luminaire luminous flux 467lm 2700K Ra80 220-240V STEP DIM	
		Interruttore incluso / Switch included					
Tavolo / Table	C052_011.0209	12	31,6	4¾	12 ¾"	Potenza assorbita apparecchio / Luminaire power consumption 5W Flusso luminoso LED / LED luminous flux 467lm 2700K Ra80 220-240V STEP DIM	

Fotometrie e Classi Energetiche disponibili www.panzeri.it / Photometric data and Energy Label available at www.panzeri.it

CODICI COLORI DISPONIBILI / CODES AVAILABLE COLOURS

01 Bianco
White

02 Nero
Black

17 Bronzo
Bronze

19 Ottone satinato
Mat brass

30 Titanio
Titanium



TUBINO

Matteo Thun 2019

L'essenzialità di Tubino è frutto della ricerca di equilibrio e proporzionalità tra più cilindri che si compenetrano. La testa ricorda una torcia d'altri tempi, lo snodo invita subito all'interazione per individuarne l'orientamento preferito. La famiglia comprende le versioni tavolo, parete/soffitto (disponibile anche a incasso) e terra. Tubino tavolo è disponibile in versione ON/OFF nelle colorazioni bianco e nero satinato con cavo trasparente e nella versione Tubino Plus con comando STEP DIM a 5 regolazioni di intensità luminosa in finitura champagne bronzo e titanio con cavo di alimentazione tra la testa e la struttura in tessuto. Grazie alla capacità di ricreare scenari diversi e alla possibilità di adattare la luce con un semplice gesto, Tubino parete trova facilmente applicazione alla testata del letto, sia in ambito residenziale che hospitality. Nella versione terra le sorgenti raddoppiano, il posizionamento sulla struttura a stelo è pensato per consentirne un utilizzo ideale anche come lampada da lettura. Bianco e nero satinato, le finiture disponibili.

The essentiality of Tubino is the result of the search for balance and proportionality between cylinders. The head is reminiscent of a torch of past times, the joint immediately invites to interaction, to identify its preferred orientation. The family includes the table, wall/ceiling (also available as recessed) and floor versions. The Tubino table version is available ON/OFF in white and matt black colors with transparent cable and in the Tubino Plus version and STEP DIM control with 5 light intensity settings in champagne bronze and titanium finish with fabric cable between the head and the structure. Thanks to the ability to recreate different scenarios and the possibility of adapting the light with a simple gesture, Tubino wall can be easily applied to the bedhead, both in residential and hospitality projects. In the ground version the lighting sources double, the positioning on the stem structure is designed to allow an ideal use also as a reading lamp. White and mat black finishes are available.



















TUBINO PLUS

Matteo Thun 2019





Champagne finishing with champagne fabric cable
 Bronze finishing with bordeaux fabric cable
 Titanium finishing with green fabric cable

SOLO PER VERSIONE TUBINO PLUS TAVOLO
ONLY FOR TUBINO PLUS TABLE VERSION

TUBINO		Matteo Thun 2019	Registered Design		LED CE IP20 (☐ Table / Floor)		
		CODICE / CODE	CM Ø H	INCHES Ø H	FONTI LUMINOSE / LIGHT SOURCES		
Tavolo / Table	C07301.001.0201	Transparent cable	10,4	48	4"	19"	Potenza assorbita apparecchio / Luminaire power consumption 6,5W Flusso luminoso apparecchio / Luminaire luminous flux 375lm 2700K Ra80 220-240V
	C07306.001.0201						
Parete-soffitto / Wall-ceiling	A07301.001.0201		10,4	23	4"	9"	Potenza assorbita apparecchio / Luminaire power consumption 6,5W Flusso luminoso apparecchio / Luminaire luminous flux 375lm 2700K Ra80 220-240V
	A07305.001.0201						
	A07306.001.0201						
	A07317.001.0201						
	A07330.001.0201						
Parete-soffitto incasso Recessed wall-ceiling	X07301.001.0201		10	23	4"	9"	Potenza assorbita apparecchio / Luminaire power consumption 6,5W Flusso luminoso apparecchio / Luminaire luminous flux 375lm 2700K Ra80 220-240V
	X07305.001.0201						
	X07306.001.0201						
	X07317.001.0201						
	X07330.001.0201						
Terra / Floor	T07301.002.0201	Transparent cable	30	165	11 3/4"	65"	Potenza assorbita apparecchio / Luminaire power consumption 13W Flusso luminoso LED / LED luminous flux 375+375lm 2700K Ra80 220-240V
	T07306.002.0201						
Tavolo PLUS / Table PLUS	C07305.001.0209	* Champagne fabric cable	10,4	48	4"	19"	Potenza assorbita apparecchio / Luminaire power consumption 6,5W Flusso luminoso apparecchio / Luminaire luminous flux 375lm 2700K Ra80 220-240V STEP DIM
	C07317.001.0209	* Bordeaux fabric cable					
	C07330.001.0209	* Green fabric cable					

*** SOLO PER VERSIONE TUBINO PLUS TAVOLO / ONLY FOR TUBINO PLUS TABLE VERSION**

Fotometrie e Classi Energetiche disponibili www.panzeri.it / Photometric data and Energy Label available at www.panzeri.it

CODICI COLORI DISPONIBILI / CODES AVAILABLE COLOURS

01 Bianco White	05 Champagne Champagne	06 Nero satinato Mat black	17 Bronzo Bronze	30 Titanio Titanium
				

FIREFLY in the sky

Matteo Thun 2019

L'ispirazione da cui nasce è quella della classica lampada da tavolo, la riconoscibilità della silhouette senza tempo stabilisce una connessione empatica. Leggera negli spostamenti e innovativa nel "core", Firefly in the sky è un apparecchio a batteria da tavolo e a picchetto adatto ad ambienti esterni, in cui tradizione e innovazione creano insieme un connubio perfetto. La testa removibile racchiude tutta la tecnologia impiegata, sistema di aggancio magnetico, batteria ricaricabile tramite USB-C, sorgente LED e comando STEP DIM a 5 regolazioni di intensità luminosa. Base antiscivolo già in dotazione. Un ingegnoso doppio meccanismo antitaccheggio, uno per il fissaggio al piano e l'altro per vincolare la testa alla base, massimizza l'efficienza e la sicurezza nell'utilizzo per l'illuminazione dei tavoli in ambito public, da ordinare separatamente. La versione picchetto consente di illuminare il verde ed i percorsi risolvendo ogni vincolo di posizionamento o collegamento e riducendo al minimo l'impatto sull'ambiente. Bianco, nero satinato, bronzo, titanio e champagne le finiture disponibili.

The inspiration comes from the classic table lamp, the recognizability of the timeless silhouette set up an empathic connection. Easy to move and innovative in the "core", Firefly in the sky is an outdoor battery table and peg lamp, wherein tradition and innovation match perfectly. The removable head contains all the technology used, magnetic coupling system, rechargeable battery via USB-C, LED source and STEP DIM control with 5 light intensity settings. Anti-slip base included. An ingenious double anti-theft mechanism, one to fix it to the table and the other to fix the head to the structure, maximizes efficiency and safety in table lighting for public use, to be ordered separately. The peg version allows to light the green and the paths by solving any constraint of positioning or power supply, minimizing the impact on the environment. White, mat black, bronze, titanium and champagne finishes are available.











JW Marriott Venice Resort & Spa (IT)



JW Marriott Venice Resort & Spa (IT)





JW Marriott Venice Resort & Spa (IT)







FIREFLY in the sky

Matteo Thun 2019

Registered Design

LED CE IP65

CODICE / CODE

CM Ø

H

INCHES Ø

H

FONTI LUMINOSE / LIGHT SOURCES

Tavolo / Table

C078_011.0214

12,4

26,5

4 9/16"

10 5/8"

Potenza assorbita apparecchio / Luminaire power consumption 2W
Flusso luminoso apparecchio / Luminaire luminous flux 161lm
2700K Ra80 5,0V DC STEP DIM

XM07800.201.0099



Accessorio antitaccheggio per versione tavolo
Anti-theft option for table lamp

Terra / Floor

PE078_011.0214

12,4

57,6

4 9/16"

22 3/8"

Da fissare al suolo / To be fixed to the ground

Potenza assorbita apparecchio / Luminaire power consumption 2W
Flusso luminoso LED / LED luminous flux 161lm
2700K Ra80 5,0V DC STEP DIM

In funzione delle condizioni di utilizzo per una ricarica di circa 4 ore si stima un'autonomia di circa 7 ore con intensità della luce al 100% e di circa 24 ore con intensità della luce al 25%. Indicatore LED per lo stato di carica. La carica avviene tramite USB-C. Caricabatteria e cavetto inclusi.

Depending on the conditions of use for a recharge of approximately 4 hours, an autonomy of approximately 7 hours is estimated with 100% light intensity and approximately 24 hours with 25% light intensity. LED indicator for the load status. Charging takes place via USB-C. Battery charger and cable Included.

Fotometrie e Classi Energetiche disponibili www.panzeri.it / Photometric data and Energy Label available at www.panzeri.it

CODICI COLORI DISPONIBILI / CODES AVAILABLE COLOURS

01 Bianco
White

05 Champagne
Champagne

06 Nero satinato
Mat black

17 Bronzo
Champagne

30 Titanio
Titanium



ZERO SHAPES

Enzo Panzeri 2018/19

Zero Shapes è una famiglia di profili di luce composta dalle forme Zero Ellipse, Zero Round (anche Vertical) e Zero Square. Dall'installazione della singola shape alla sospensione di più forme in relazione tra loro, il ventaglio di composizioni ricreabili non ha limiti. Per la sospensione di più apparecchi abbiamo disegnato rosoni che ne facilitano l'installazione, sia per configurazioni a cascata che a sviluppo orizzontale. Esempi di applicazioni sono visualizzabili nella sezione dedicata "Rosoni per Zero Shapes". I rosoni sono da ordinare separatamente per qualunque tipologia di installazione.

Zero Shapes is a family of light profiles composed of the Zero Ellipse, Zero Round (also Vertical) and Zero Square. From the installation of the single shape to the suspension of several lighting fixtures in relation to each other, the range of configurations has no limits. For the suspension of several elements we have designed canopies that facilitate mounting, both for cascade configurations and for horizontal development. Examples of applications can be visualized in the related paragraph "Canopies for Zero Shapes". Canopies are to be ordered separately for any type of installation.



ZERO SHAPES

ZERO ELLIPSE

Enzo Panzeri 2019

Zero Ellipse è un profilo di luce sottile, espressione di un design teso ad unire funzionalità ed emozione. Il minimalismo della struttura combinato all'emissione di luce interna conferisce a Zero Ellipse un'incredibile leggerezza. Equipaggiato con tecnologia LED DALI / PUSH DIM e adatto ad originali composizioni multiple anche in affiancamento allo Zero Round (anche vertical) e allo Zero Square. Abbiamo quindi disegnato rosoni che rispondessero sapientemente e con minimo impatto alle esigenze di sospensione di più apparecchi, da ordinare separatamente per qualunque tipologia di installazione. Esempi di applicazioni sono visualizzabili nella sezione dedicata "Rosoni per Zero Shapes". Bianco, nero, titanio, bronzo e ottone satinato le finiture disponibili.

Zero Ellipse is a thin light profile, expression of a design aimed at combining functionality and emotion. The minimalism of the structure combined with the emission of internal light gives to Zero Ellipse an incredible lightness. It is equipped with DALI / PUSH DIM LED and particularly suitable for original multiple configurations also alongside the Zero Round (also vertical) and Zero Square lighting fixture. We therefore designed canopies that expertly responds with minimal impact to the suspension needs of several elements, to be ordered separately for any type of installation. Examples can be visualized in the related paragraph "Canopies for Zero Shapes". White, black, titanium, bronze and mat brass finishes are available.





ROSONI PER ZERO SHAPES A PAGINA 88 / CANOPIES FOR ZERO SHAPES PAGE 88

ZERO SHAPES

ZERO ELLIPSE

Enzo Panzeri 2019

Registered Design



CODICE / CODE

CM A x B

H

INCHES A x B

H

FONTI LUMINOSE / LIGHT SOURCES

Sospensione / Suspension

M031_..130.0210

59x130

3

23 ¼" x 51 ⅝"

1 ½"

Potenza assorbita apparecchio / Luminaire power consumption 45W
Flusso luminoso apparecchio / Luminaire luminous flux 4947lm
2700K Ra80 24V DC

No rosone / no driver

No canopy / no driver

Cable lenght 500 / 197"

Fotometrie e Classi Energetiche disponibili www.panzeri.it / Photometric data and Energy Label available at www.panzeri.it

CODICI COLORI DISPONIBILI / CODES AVAILABLE COLOURS

DISPONIBILI A RICHIESTA LED 3000K / ON REQUEST 3000K LED AVAILABLE

01 Bianco
White

02 Nero
Black

17 Bronzo
Bronze

19 Ottone satinato
Mat brass

30 Titanio
Titanium



ZERO SHAPES

ZERO SQUARE

Enzo Panzeri 2019

Zero Square è un profilo di luce sottile, espressione di un design teso ad unire funzionalità ed emozione. Il minimalismo della struttura combinato all'emissione di luce interna conferisce a Zero Square un'incredibile leggerezza. Equipaggiato con tecnologia LED DALI / PUSH DIM e adatto ad originali composizioni multiple anche in affiancamento allo Zero Round (anche vertical) e allo Zero Ellipse. Abbiamo quindi disegnato rosoni che rispondessero sapientemente e con minimo impatto alle esigenze di sospensione di più apparecchi, da ordinare separatamente per qualunque tipologia di installazione. Esempi di applicazioni sono visualizzabili nella sezione dedicata "Rosoni per Zero Shapes". Bianco, nero, titanio, bronzo e ottone satinato le finiture disponibili.

Zero Square is a thin light profile, expression of a design aimed at combining functionality and emotion. The minimalism of the structure combined with the emission of internal light gives to Zero Square an incredible lightness. It is equipped with DALI / PUSH DIM LED and particularly suitable for original multiple configurations also alongside the Zero Round (also vertical) and Zero Ellipse lighting fixture. We therefore designed canopies that expertly responds with minimal impact to the suspension needs of several elements, to be ordered separately for any type of installation. Examples can be visualized in the related paragraph "Canopies for Zero Shapes". White, black, titanium, bronze and mat brass finishes are available.



M03217.050.0210 Zero Square / 50
M03217.075.0210 Zero Square / 75
XM03317.523.0002 Rosone / Canopy







M03230.050.0210	Zero Square / 50
M03330.100.0210	Zero Round / 100
M03230.075.0210	Zero Square / 70
XM03330.533.0002	Rosone / Canopy

ROSONI PER ZERO SHAPES A PAGINA 88 / CANOPIES FOR ZERO SHAPES PAGE 88

ZERO SHAPES

ZERO SQUARE

Enzo Panzeri 2019

Registered Design

LED CE IP20 

CODICE / CODE

CM A x B

H

INCHES A x B

H

FONTI LUMINOSE / LIGHT SOURCES

Sospensione / Suspension

M032__050.0210

46x46

3

18 1/8" x 18 1/8"

1 1/2"

Potenza assorbita apparecchio / Luminaire power consumption 24W
Flusso luminoso apparecchio / Luminaire luminous flux 2473lm
2700K Ra80 24V DC

No rosone / no driver

No canopy / no driver

Cable lenght 500 / 197"

M032__075.0210

68x68

3

26 3/4" x 26 3/4"

1 1/2"

Potenza assorbita apparecchio / Luminaire power consumption 34W
Flusso luminoso apparecchio / Luminaire luminous flux 3710lm
2700K Ra80 24V DC

Cable lenght 500 / 197"

Fotometrie e Classi Energetiche disponibili www.panzeri.it / Photometric data and Energy Label available at www.panzeri.it

CODICI COLORI DISPONIBILI / CODES AVAILABLE COLOURS

DISPONIBILI A RICHIESTA LED 3000K / ON REQUEST 3000K LED AVAILABLE

01 Bianco
White

02 Nero
Black

17 Bronzo
Bronze

19 Ottone satinato
Mat brass

30 Titanio
Titanium



ZERO SHAPES

ZERO ROUND

Enzo Panzeri 2018/19

Zero Round è un profilo di luce sottile, espressione di un design teso ad unire funzionalità ed emozione. Il minimalismo della struttura combinato all'emissione di luce interna conferisce a Zero Round un'incredibile leggerezza, sia nella versione a sospensione che nella nuova declinazione a parete. Tutte le sospensioni sono equipaggiate con tecnologia LED DALI / PUSH DIM e sono disponibili sia per applicazione orizzontale che verticale in tre diametri, rendendo Zero Round particolarmente adatto ad originali composizioni multiple, anche in affiancamento allo Zero Square e allo Zero Ellipse. Abbiamo quindi disegnato rosoni che rispondessero sapientemente e con minimo impatto alle esigenze di sospensione di più apparecchi, da ordinare separatamente per qualunque tipologia di installazione. Esempi di applicazioni sono visualizzabili nella sezione dedicata "Rosoni per Zero Shapes". Bianco, nero, titanio, bronzo e ottone satinato le finiture disponibili.

Zero Round is a thin light profile, expression of a design aimed at combining functionality and emotion. The minimalism of the structure combined with the emission of internal light gives to Zero an incredible lightness, both in the suspension and in the new wall version. All suspensions are equipped with DALI / PUSH DIM LED and are available for both horizontal and vertical application in three diameters, making Zero Round particularly suitable for original multiple configurations also alongside the Zero Square and Zero Ellipse lighting fixture. We therefore designed canopies that expertly responds with minimal impact to the suspension needs of several elements, to be ordered separately for any type of installation. Examples can be visualized in the related paragraph "Canopies for Zero Shapes". White, black, titanium, bronze and mat brass finishes are available.







M03417.050.0210 Zero Round Vertical / 50
M03430.075.0210 Zero Round Vertical / 75
M03417.100.0210 Zero Round Vertical / 100
XM03401.531.0002 Rosone / Canopy























M03330.050.0210	Zero Round / 50
M03330.075.0210	Zero Round / 75
M03330.100.0210	Zero Round / 100
XM03330.533.0002	Rosone / Canopy

ROSONI PER ZERO SHAPES A PAGINA 88 / CANOPIES FOR ZERO SHAPES PAGE 88

ZERO SHAPES

ZERO ROUND

	Enzo Panzeri 2018/19	Registered Design				LED CE IP20 
	CODICE / CODE	CM Ø	H	INCHES Ø	H	FONTI LUMINOSE / LIGHT SOURCES
Sospensione orizzontale Horizontal suspension	M033__050.0210	50	3	19 3/8"	1 1/2"	Potenza assorbita apparecchio / Luminaire power consumption 24W Flusso luminoso apparecchio / Luminaire luminous flux 2473lm 2700K Ra80 24V DC
		Cable lenght 500 / 197"				
No rosone / no driver No canopy / no driver	M033__075.0210	74	3	29 1/8"	1 1/2"	Potenza assorbita apparecchio / Luminaire power consumption 34W Flusso luminoso apparecchio / Luminaire luminous flux 3710lm 2700K Ra80 24V DC
		Cable lenght 500 / 197"				
	M033__100.0210	98	3	38 3/8"	1 1/2"	Potenza assorbita apparecchio / Luminaire power consumption 45W Flusso luminoso apparecchio / Luminaire luminous flux 4947lm 2700K Ra80 24V DC
		Cable lenght 500 / 197"				

ZERO ROUND VERTICAL

Sospensione verticale Vertical suspension	M034__050.0210	50	3	19 3/8"	1 1/2"	Potenza assorbita apparecchio / Luminaire power consumption 24W Flusso luminoso apparecchio / Luminaire luminous flux 2473lm 2700K Ra80 24V DC
		Cable lenght 500 / 197"				
No rosone / no driver No canopy / no driver	M034__075.0210	74	3	29 1/8"	1 1/2"	Potenza assorbita apparecchio / Luminaire power consumption 34W Flusso luminoso apparecchio / Luminaire luminous flux 3710lm 2700K Ra80 24V DC
		Cable lenght 500 / 197"				
	M034__100.0210	98	3	38 3/8"	1 1/2"	Potenza assorbita apparecchio / Luminaire power consumption 45W Flusso luminoso apparecchio / Luminaire luminous flux 4947lm 2700K Ra80 24V DC
		Cable lenght 500 / 197"				
Parete / Wall	A033__025.0201	26	3	10 1/4"	1 1/2"	Potenza assorbita apparecchio / Luminaire power consumption 13W Flusso luminoso apparecchio / Luminaire luminous flux 965lm 2700K Ra80 24V DC

Fotometrie e Classi Energetiche disponibili www.panzeri.it / Photometric data and Energy Label available at www.panzeri.it

CODICI COLORI DISPONIBILI / CODES AVAILABLE COLOURS

DISPONIBILI A RICHIESTA LED 3000K / ON REQUEST 3000K LED AVAILABLE

01 Bianco
White

02 Nero
Black

17 Bronzo
Bronze

19 Ottone satinato
Mat brass

30 Titanio
Titanium



ROSONI PER ZERO SHAPES / ZERO SHAPES CANOPIES

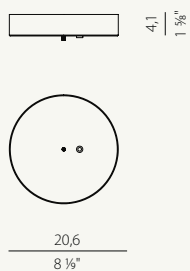
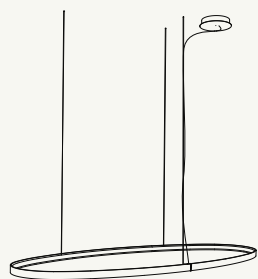

XM033_..511.0002

Rosone per collegamento elettrico di 1 apparecchio ORIZZONTALE con driver DALI / PUSH DIM
Canopy for 1 HORIZONTAL fixture power supply with driver DALI / PUSH DIM

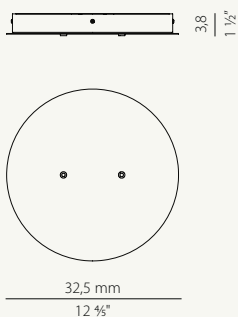
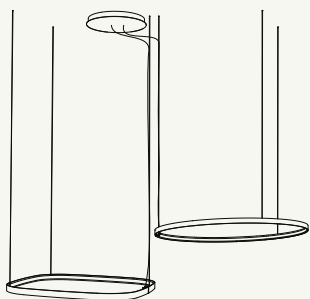

XM033_..522.0002

Rosone per collegamento elettrico di 2 apparecchi ORIZZONTALI con driver DALI / PUSH DIM
Canopy for 2 HORIZONTAL fixtures power supply with driver DALI / PUSH DIM

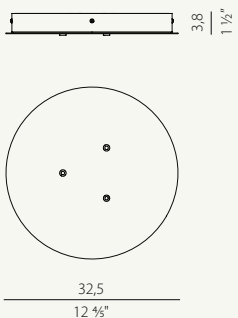
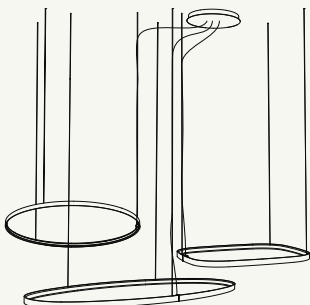

XM033_..523.0002

Rosone per collegamento elettrico di 3 apparecchi ORIZZONTALI con driver DALI / PUSH DIM
Canopy for 3 HORIZONTAL fixtures power supply with driver DALI / PUSH DIM

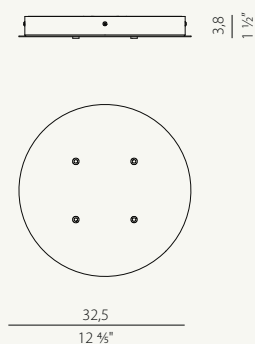
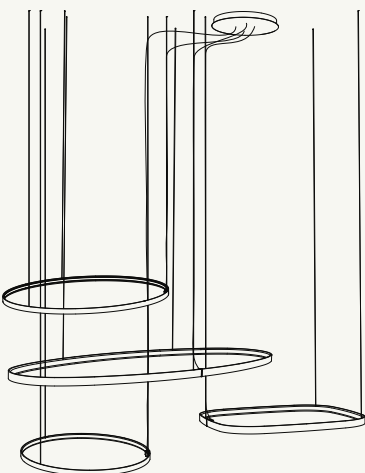

XM033_..524.0002

Rosone per collegamento elettrico di 4 apparecchi ORIZZONTALI con driver DALI / PUSH DIM
Canopy for 4 HORIZONTAL fixtures power supply with driver DALI / PUSH DIM

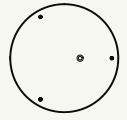
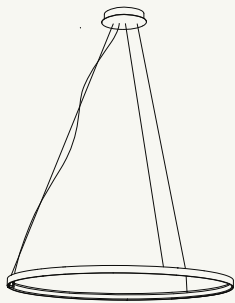

NOVELTY

XM033__531.0002

Rosone per collegamento elettrico e sospensione di 1 apparecchio ORIZZONTALE con driver DALI / PUSH DIM
Canopy for 1 HORIZONTAL fixture power supply with joined steel cables with driver DALI / PUSH DIM

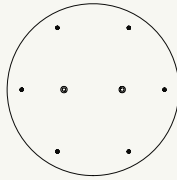
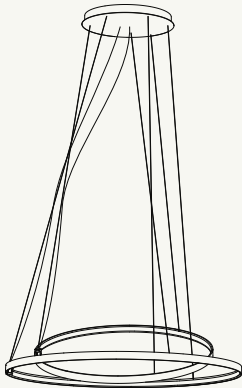

XM033__532.0002

Rosone per collegamento elettrico e sospensione di 2 apparecchi ORIZZONTALI con driver DALI / PUSH DIM
Canopy for 2 HORIZONTAL fixtures power supply with joined steel cables with driver DALI / PUSH DIM

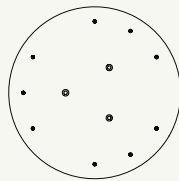
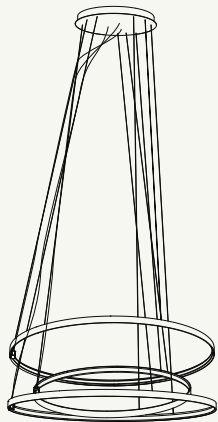

XM033__533.0002

Rosone per collegamento elettrico e sospensione di 3 apparecchi ORIZZONTALI con driver DALI / PUSH DIM
Canopy for 3 HORIZONTAL fixtures power supply with joined steel cables with driver DALI / PUSH DIM

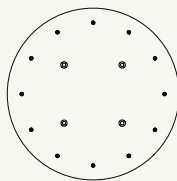
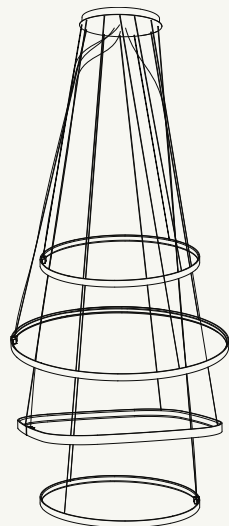

XM033__534.0002

Rosone per collegamento elettrico e sospensione di 4 apparecchi ORIZZONTALI con driver DALI / PUSH DIM
Canopy for 4 HORIZONTAL fixtures power supply with joined steel cables with driver DALI / PUSH DIM

ROSONI PER ZERO SHAPES / ZERO SHAPES CANOPIES

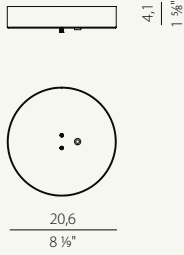

XM034_.531.0002

Rosone per collegamento elettrico e sospensione di 1 apparecchio VERTICALE con driver DALI / PUSH DIM
Canopy for 1 VERTICAL fixture power supply with joined steel cables with driver DALI / PUSH DIM

NOVELTY

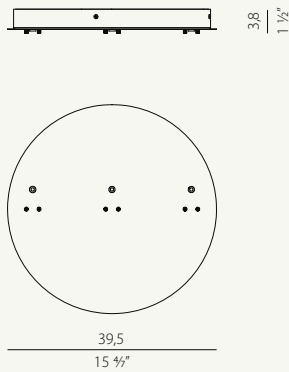
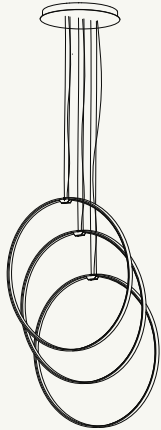

XM034_.533.0002

Rosone per collegamento elettrico e sospensione di 3 apparecchi VERTICALI con driver DALI / PUSH DIM
Canopy for 3 VERTICAL fixtures power supply with joined steel cables with driver DALI / PUSH DIM

NOVELTY

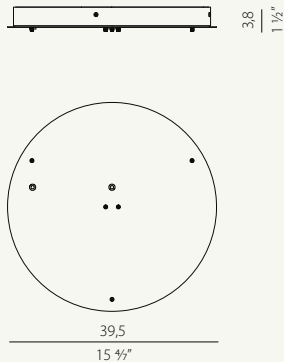
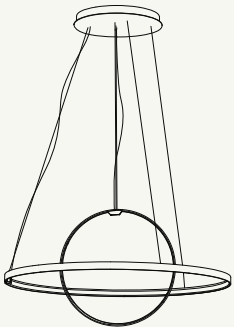

XM034_.552.0002

Rosone per collegamento elettrico e sospensione di 1 apparecchi VERTICALE e 1 apparecchio ORIZZONTALE con driver DALI / PUSH DIM
Canopy for 1 VERTICAL and 1 HORIZONTAL fixtures power supply with joined steel cables with driver DALI / PUSH DIM

NOVELTY

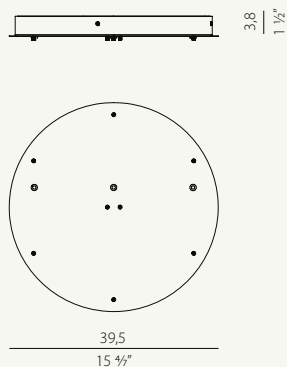
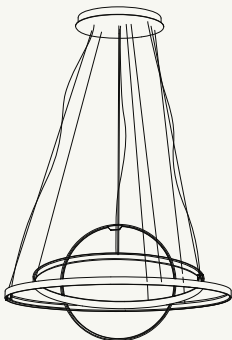

XM034_.553.0002

Rosone per collegamento elettrico e sospensione di 1 apparecchio VERTICALE e 2 apparecchi ORIZZONTALI con driver DALI / PUSH DIM
Canopy for 1 VERTICAL and 2 HORIZONTAL fixtures power supply with joined steel cables with driver DALI / PUSH DIM

NOVELTY

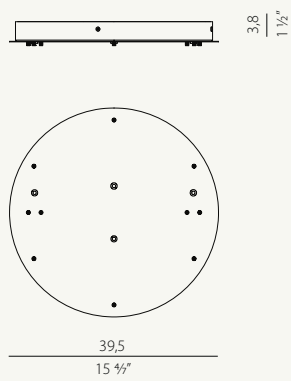
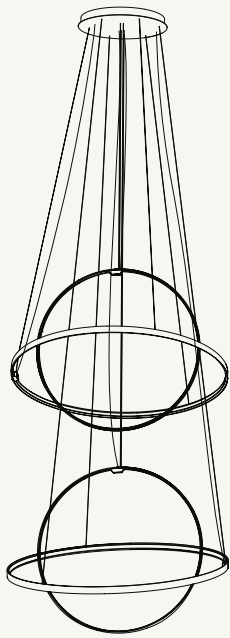

XM034__554.0002

Rosone per collegamento elettrico e sospensione di 2 apparecchi VERTICALI e 2 apparecchi ORIZZONTALI con driver DALI / PUSH DIM
 Canopy for 2 VERTICAL and 2 HORIZONTAL fixtures power supply with joined steel cables with driver DALI / PUSH DIM

NOVELTY

CODICI COLORI DISPONIBILI / CODES AVAILABLE COLOURS

01 Bianco
White

02 Nero
Black

17 Bronzo
Bronze

19 Ottone satinato
Mat brass

30 Titanio
Titanium

MATRICE DI COMPATIBILITA' ROSONI/APPARECCHI ZERO SHAPES - CANOPIES/ZERO SHAPES FIXTURES MATRIX

NUMERO E TIPO DI APPARECCHI PER ROSONE / KIND AND FIXTURES NUMBER FOR CANOPY		
ROSONE/CANOPY	ZERO ROUND VERTICAL	ZERO ROUND O/OR ZERO SQUARE O/OR ZERO ELLIPSE
XM033__511.0002		1 (solo collegamento elettrico - power supply only)
XM033__522.0002		2 (solo collegamento elettrico - power supply only)
XM033__523.0002		3 (solo collegamento elettrico - power supply only)
XM033__524.0002		4 (solo collegamento elettrico - power supply only)
XM033__531.0002		1
XM033__532.0002		2
XM033__533.0002		3
XM033__534.0002		4
XM034__531.0002	1	
XM034__533.0002	3	
XM034__552.0002	1	1
XM034__553.0002	1	2
XM034__554.0002	2	2

ZIG ZAG

Jason Bird 2019

Un'illuminazione straordinaria incontra l'assorbimento del suono in Zig Zag. Una cattiva acustica degli open spaces comprende uffici che portano ad abbassare il livello di comfort e la produttività per i dipendenti che lavorano all'interno di questi ambienti. Zig Zag combina un'illuminazione adatta per le aree di lavoro negli uffici, con proprietà fonoassorbenti per migliorare l'acustica negli open spaces. Il nome Zig Zag richiama la geometria di questa sorprendente lampada. Una forma semplice e riconoscibile che massimizza la superficie di assorbimento del suono e riduce il riflesso diretto delle onde sonore. Disponibile modulo da un metro con emissione diretta e indiretta, il materiale fonoassorbente in PET è disponibile nella versione carbone, colori grigio chiaro, blu scuro, verde smeraldo o arancio disponibili su richiesta per il contract.

Striking illumination meets sound absorbing in Zig Zag. Poor acoustics in open spaces include offices lead to reduce comfort and productive for the employees who work within these environments. Zig Zag combines suitable illumination to be used as task lighting in offices, with sound absorbing properties to improve acoustics in open spaces. Zig Zag refers directly to the geometry of this striking lamp. A simple and recognizable shape that maximizes the sound absorption surface area and reduces the direct reflection of sound waves. One meter module with direct and indirect emission is available, PET sound absorbing material is available in the charcoal as standard with light gray, dark blue, emerald green or orange colors available on request for contract.

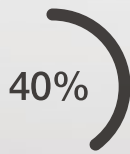
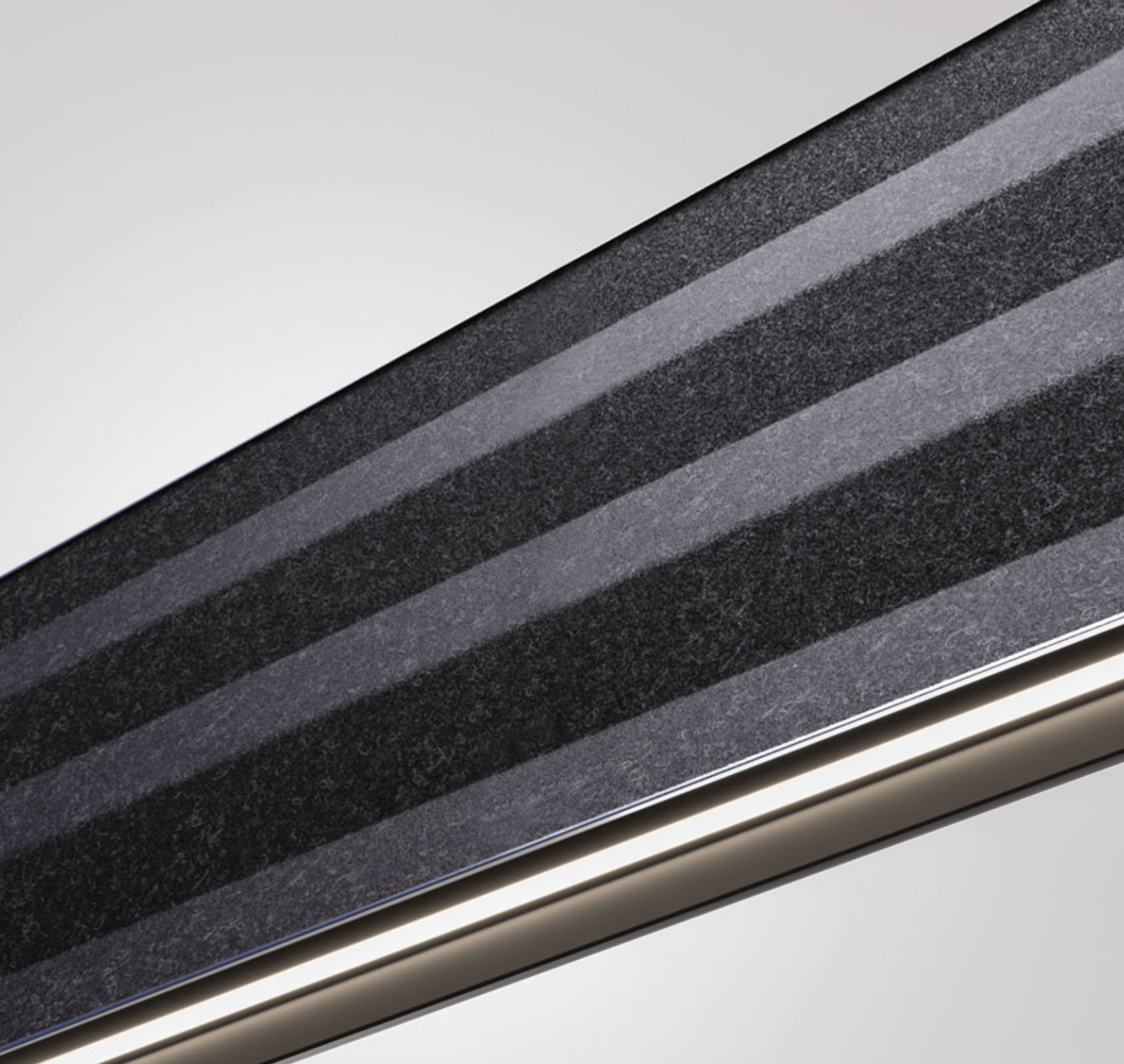

Of employees believe their workplace does not foster creativity or collaboration



Of employees say their workplace can be noisy, distracting and lacks privacy



Highly durable providing long term stability with all fixtures holding a Group 1 fire Rating



Acoustic material absorbs up to 70% of reverberated sound with an NRC of 0.7.

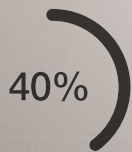

Of employees believe their workplace does not foster creativity or collaboration



Of employees say their workplace can be noisy, distracting and lacks privacy



Highly durable providing long term stability with all fixtures holding a Group 1 fire Rating



Acoustic material absorbs up to 70% of reverberated sound with an NRC of 0.7.





ZIG ZAG

Jason Bird 2019

 **CE** IP40

	CODICE / CODE	L CM	H	L INCHES	H	FONTI LUMINOSE / LIGHT SOURCES
Sospensione / Suspension	L04334.100.0102	102	29	40 ½"	11 ¾"	Potenza assorbita apparecchio / Luminaire power consumption 50W Flusso luminoso apparecchio / Luminaire luminous flux 3011lm 3000K Ra80 220-240W DALI / PUSH DIM

Fotometrie e Classi Energetiche disponibili www.panzeri.it / Photometric data and Energy Label available at www.panzeri.it

CODICI COLORI DISPONIBILI / CODES AVAILABLE COLOURS

- UGR < 19 in funzione delle condizioni di installazione
UGR < 19 depending on installation conditions

34 Grigio micaceo
Micaceous grey



COLORI DISPONIBILI / AVAILABLE COLOURS

Carbone
Charcoal



Grigio chiaro (a richiesta)
Light grey (available on request)



Blu scuro (a richiesta)
Dark blue (available on request)



Verde smeraldo (a richiesta)
Emerald green (available on request)



Arancione (a richiesta)
Orange (available on request)



ELY EMY EVY

Silvia Poma 2019

Una famiglia di lampade a sospensione in vetro soffiato satinato, caratterizzate dal trattamento del vetro secondo antiche tecniche di decorazione. Rigadin, Balloton, e Ballotondo sono i nomi che prendono queste lavorazioni, conferendo rispettivamente ad Ely una finitura rigata, ad Emy una trama romboidale e ad Evy un particolare pattern sferico. Le tre sospensioni si differenziano per tipologia di rilievo e anche per forma, il dialogo tra Ely Emy e Evy si arricchisce di significati nella ricerca di un equilibrio perfetto tra combinazioni cromatiche ed installazioni singole o multiple. Cristallo, acciaio, ambra, bronzo, tabacco e verde le colorazioni vetro disponibili. Accessori in ottone satinato. Disponibile rosone a scomparsa e rosone per sospensioni multiple. Lampadina a LED disponibile a catalogo.

Suspension lamps in satin blown glass, characterized by the treatment of glass according to ancient decoration techniques. Rigadin, Balloton, and Ballotondo are the names that take these techniques, giving Ely a striped finish, Emy a rhomboidal texture and Evy a particular spherical pattern. The three suspensions differ in type of relief and also in shape, the dialogue between Ely Emy and Evy is enriched with meanings in the search for a perfect balance between color combinations and single or multiple installations. Crystal, steel, amber, bronze, tobacco and green are the glass colors available. Accessories in satin brass. Recessed canopy and canopies for multiple suspensions are available. LED bulb available in the catalog.



Emy

Ely

Evy







ELY EMY EVY		Silvia Poma 2019				LED CE IP20
	CODICE / CODE	CM Ø	H	INCHES Ø	H	FONTI LUMINOSE / LIGHT SOURCES
Ely Sospensione / Suspension	L100_...000.0000	11,2	16,9	4 3/8"	6 2/3"	LED retrofit bulb G9 Lmax. 60mm - Ø max. 17,5mm max 48W G9
		Cable lenght 300 / 118 1/2"				
	M100_...000.0000	11,2	16,9	4 3/8"	6 2/3"	LED retrofit bulb G9 Lmax. 60mm - Ø max. 17,5mm max 48W G9
	No rosone / No canopy	Cable lenght 300 / 118 1/2"				
	M800					Appendimento in policarbonato per sospensione Polycarbonate hook for suspension
Emy Sospensione / Suspension	L101_...000.0000	16	12,2	6 1/8"	4 4/5"	LED retrofit bulb G9 Lmax. 60mm - Ø max. 17,5mm max 48W G9
		Cable lenght 300 / 118 1/2"				
	M101_...000.0000	16	12,2	6 1/8"	4 4/5"	LED retrofit bulb G9 Lmax. 60mm - Ø max. 17,5mm max 48W G9
	No rosone / No canopy	Cable lenght 300 / 118 1/2"				
	M800					Appendimento in policarbonato per sospensione Polycarbonate hook for suspension
Evy Sospensione / Suspension	L102_...000.0000	15,5	15,2	6 1/8"	6"	LED retrofit bulb G9 Lmax. 60mm - Ø max. 17,5mm max 48W G9
		Cable lenght 300 / 118 1/2"				
	M102_...000.0000	15,5	15,2	6 1/8"	6"	LED retrofit bulb G9 Lmax. 60mm - Ø max. 17,5mm max 48W G9
	No rosone / No canopy	Cable lenght 300 / 118 1/2"				
	M800					Appendimento in policarbonato per sospensione Polycarbonate hook for suspension

+ ELECTRIC OPTIONS:

XM5/G9LED 4W G9 3000K Ra80 330lm 110-240V NOT DIMMABLE



Fotometrie e Classi Energetiche disponibili www.panzeri.it / Photometric data and Energy Label available at www.panzeri.it

CODICI COLORI DISPONIBILI / COLOUR CODES AVAILABLE

19 Ottone satinato /
Mat brass



CODICI COLORI DISPONIBILI / COLOUR CODES AVAILABLE

72 Ottone satinato /
Cristallo
Mat brass / Crystal

73 Ottone satinato /
Acciaio
Mat brass / Crystal

74 Ottone satinato /
Ambra
Mat brass / Crystal

75 Ottone satinato /
Bronzo
Mat brass / Crystal

76 Ottone satinato /
Tabacco
Mat brass / Crystal

77 Ottone satinato /
Verde
Mat brass / Crystal



GONG

Studio Tecnico Panzeri 2018

Una lampada dalla forte identità, Gong caratterizza lo spazio in cui si inserisce ed attrae oltre che per le importanti dimensioni, soprattutto per la bellezza insita nella semplicità della sua forma. Un disco puro che accenna alla tridimensionalità grazie all'attento lavoro di tornitura a cui viene sottoposto. Una sospensione con emissione di luce indiretta e tecnologia LED DALI / PUSH DIM integrata. Declinabile in bianco, nero e foglia oro, Gong è un viaggio nel tempo, può proiettare nel futuro o riportare alla memoria tutto il calore di un'antica lavorazione a mano che continuiamo a tramandare da generazioni.

A lamp with a strong identity, Gong characterizes the space in which it is placed and attracts not only for its big dimensions, but above all for the beauty inherent in the simplicity of its shape. A pure disk that hints at three-dimensionality thanks to the careful turning work made on it. A suspension with indirect light emission and LED DALI / PUSH DIM technology integrated. White, black or hand-made decorated in golden leaf finishes are available, Gong is a journey through time, it can project into the future or bring to mind all the warmth of an ancient craftwork which we continue to pass on for generations.



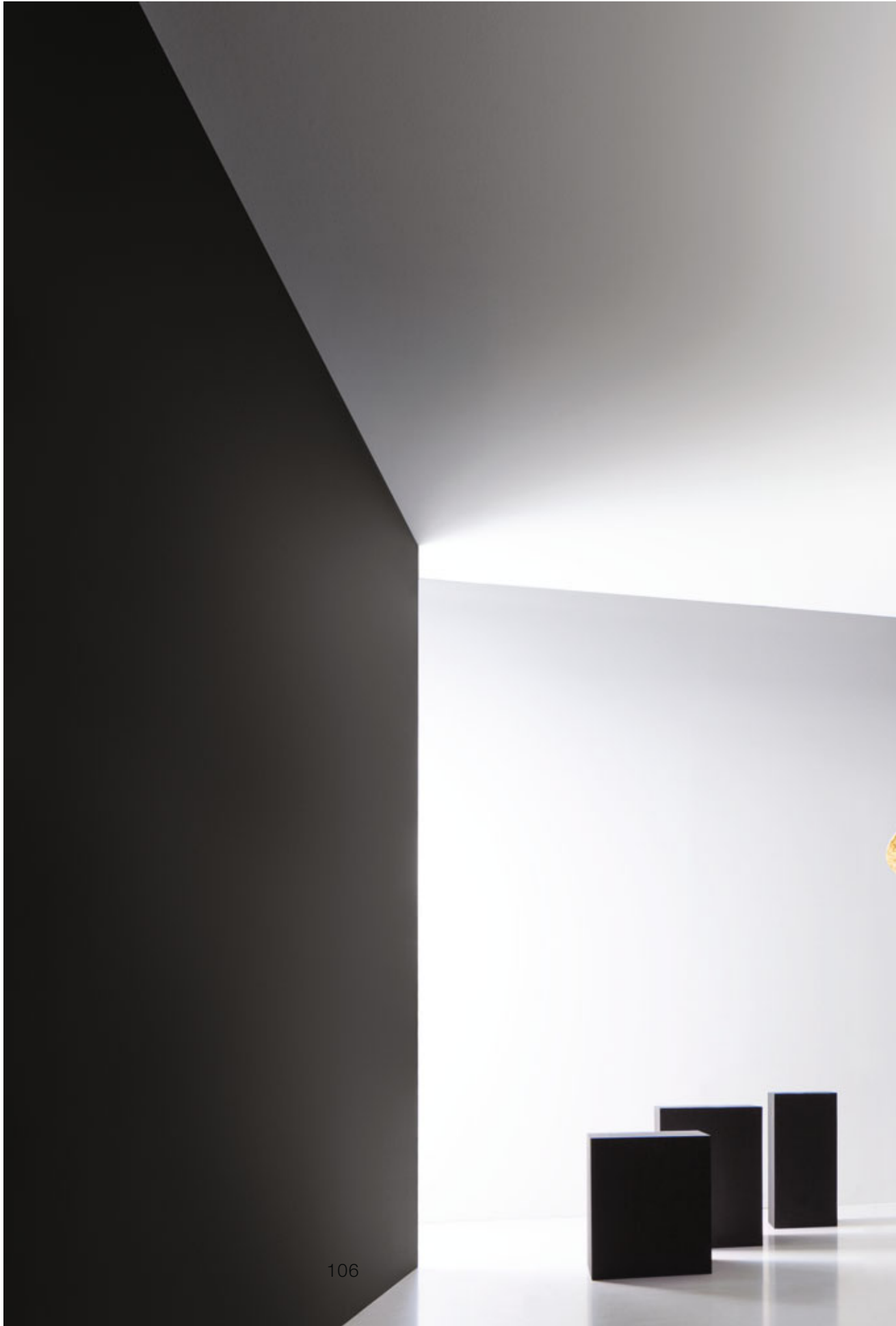













GONG

Studio Tecnico Panzeri 2018

  IP20

	CODICE / CODE	CM Ø	H	INCHES Ø	H	FONTI LUMINOSE / LIGHT SOURCES
Sospensione / Suspension	L093__060.0102	60	6,6	23 3/8"	2 3/8"	Potenza assorbita apparecchio / Luminaire power consumption 43W Flusso luminoso apparecchio / Luminaire luminous flux 5155lm 3000K Ra80 220-240V DALI / PUSH DIM Cable lenght 200 / 78 1/2"
	L093__100.0102	96	7,5	37 5/8"	3 "	Potenza assorbita apparecchio / Luminaire power consumption 88W Flusso luminoso apparecchio / Luminaire luminous flux 10310lm 3000K Ra80 220-240V DALI / PUSH DIM Cable lenght 200 / 78 1/2"

Fotometrie e Classi Energetiche disponibili www.panzeri.it / Photometric data and Energy Label available at www.panzeri.it

CODICI COLORI DISPONIBILI / COLOUR CODES AVAILABLE

01 Bianco
White

02 Nero
Black

21 Foglia oro
Gold leaf



GINEVRA

Christian Burtolf 2018

Una lampada studiata per unire in sé la tecnicità di un'emissione di luce controllata e l'estetica di un design ricercato. Ginevra offre un ventaglio di soluzioni che rispondono alla richiesta di una luce misurata e misurabile. La versione a sospensione combina emissione diretta e indiretta dimmerabili. Il dettaglio del diffusore opale microprismato arretrato e la ricerca di profondità attraverso la creazione di una zona d'ombra tra la sorgente e il corpo lampada sottolineano il valore di un prodotto che offre qualità della luce senza rinunciare all'attenzione per i dettagli nel disegno. Ginevra è disponibile con esterno nero satinato oppure bianco e interno finitura oro.

A lamp designed to combine the technology of a controlled light emission and the aesthetics of a sophisticated design. Ginevra offers a wide range of solutions that respond to the need for measured and measurable light. Pendant version is provided with dimmable direct and indirect light. The detail of the recessed microprismed opal diffuser and the search for depth through the creation of a shaded area between the lighting source and the lamp emphasizes the value of a product that offers quality of light without giving up attention to details in the design. Ginevra is available in mat black or white exterior and gold finish inside.















GINEVRA

Christian Burtolf 2018

LED CE IP20

	CODICE / CODE	CM Ø	H	INCHES Ø	H	FONTI LUMINOSE / LIGHT SOURCES
Sospensione / Suspension	L092_050.0102	53	11	20 7/8"	4 1/3"	Potenza assorbita apparecchio / Luminaire power consumption 36W Flusso luminoso apparecchio / Luminaire luminous flux 3059lm 3000K Ra80 220-240V DALI / PUSH DIM
	 Direct light/Indirect light	Cable lenght 200 / 78 5/8"				
	L092_080.0102	80	14	31 1/2"	5 1/2"	Potenza assorbita apparecchio / Luminaire power consumption 88W Flusso luminoso apparecchio / Luminaire luminous flux 8250lm 3000K Ra80 220-240V DALI / PUSH DIM
Soffitto / Ceiling	 Direct light/Indirect light	Cable lenght 200 / 78 5/8"				
	P092_050.0102	53	11	20 7/8"	4 1/3"	Potenza assorbita apparecchio / Luminaire power consumption 27W Flusso luminoso apparecchio / Luminaire luminous flux 2024lm 3000K Ra80 220-240V DALI / PUSH DIM
	P092_080.0102	80	14	31 1/2"	5 1/2"	Potenza assorbita apparecchio / Luminaire power consumption 75W Flusso luminoso apparecchio / Luminaire luminous flux 7214lm 3000K Ra80 220-240V DALI / PUSH DIM

Fotometrie e Classi Energetiche disponibili www.panzeri.it / Photometric data and Energy Label available at www.panzeri.it

CODICI COLORI DISPONIBILI / COLOUR CODES AVAILABLE

• UGR < 19 in funzione delle condizioni di installazione
UGR < 19 depending on installation conditions

80 Nero satinato/oro
Mat black/gold

81 Bianco/oro
White/gold



NOVELTY

SMOKE

Studio Tecnico Panzeri 2018

Smoke è una lampada che racconta l'antica lavorazione a mano del vetro dei maestri soffiatori veneziani in un prodotto dal design contemporaneo. Tradizione e innovazione si fondono in una famiglia di sospensioni disponibile in tre formati e due diverse colorazioni, per una massima flessibilità di configurazione. Ogni sfera è un prodotto artigianale unico, realizzato con passione. Le sfumature che caratterizzano il diffusore fanno amare questa lampada anche da spenta, la semplicità delle sue forme la rende adatta ad arredare con eleganza qualsiasi ambiente.

Smoke is a luminaire that tells the ancient handwork of the glass of venetian master blowers in a product with a contemporary design. Tradition and innovation come together in a family of suspensions available in three sizes and two different colors, for a maximum flexibility of configuration. Every sphere is a unique handicraft product, made with passion. The nuances that characterize the diffuser make you love this luminaire even when turned off, the simplicity of its design makes it suitable for finely furnishing any environment.





















SMOKE

Studio Tecnico Panzeri 2018



FONTI LUMINOSE / LIGHT SOURCES

	CODICE / CODE	CM Ø	INCHES Ø	LED	HALO
Sospensione / Suspension	L015__027.0200 NOVELTY	26,7 Cable lenght 200 / 78 ½"	10 ½"	Incl. Osram LED bulb 21W E27 2700K Ra80 2500lm 220-240V Dimmable	Max 116W E27
	L015__035.0200	35 Cable lenght 200 / 78 ½"	13 ½"	Incl. Osram LED bulb 21W E27 2700K Ra80 2500lm 220-240V Dimmable	Max 116W E27
	L015__050.0200	50 Cable lenght 200 / 78 ½"	19 ½"	Incl. Osram LED bulb 21W E27 2700K Ra80 2500lm 220-240V Dimmable	Max 116W E27

Fotometrie e Classi Energetiche disponibili www.panzeri.it / Photometric data and Energy Label available at www.panzeri.it

CODICI COLORI DISPONIBILI / COLOUR CODES AVAILABLE

4 0 Titanio / Diffusore vetro fumè
Titanium / Smoky glass diffuser

4 1 Titanio / Diffusore vetro bianco
Titanium / White glass diffuser



VIISI

Minelli - Fossati 2017

Profilo slanciato e spigoli netti, a sezione pentagonale rastremata alle estremità secondo un principio aerodinamico. Viisi è una famiglia di prodotto che completa immaginariamente la parabola disegnata dal giavellotto durante il volo, fino a toccare terra. Nella versione a sospensione si declina in due formati, a scelta tra emissione diretta o indiretta. Conservando un angolo di inclinazione con la base di appoggio, la versione da terra riproduce il comportamento della lancia quando ancora al suolo. Sorgente luminosa composta da modulo LED e dimmerazione di serie DALI / PUSH DIM integrata nel corpo lampada tramite driver ultra-flat di ultima generazione. Bianco e nero le finiture disponibili.

Slender profile and sharp edges, with pentagonal section tapered at the ends according to an aerodynamic principle. Viisi is a product family that imaginarily completes the parabola designed by the javelin during the flight, until it touches the ground. The suspension version is available in two sizes, with direct or indirect emission. By maintaining a tilt angle with the base, the ground version reproduces the behavior of the spear when it anchors to the ground. LED module light source and dimming DALI / PUSH DIM integrated into the lamp body using ultra-flat driver of latest generation. White and black finishes available.









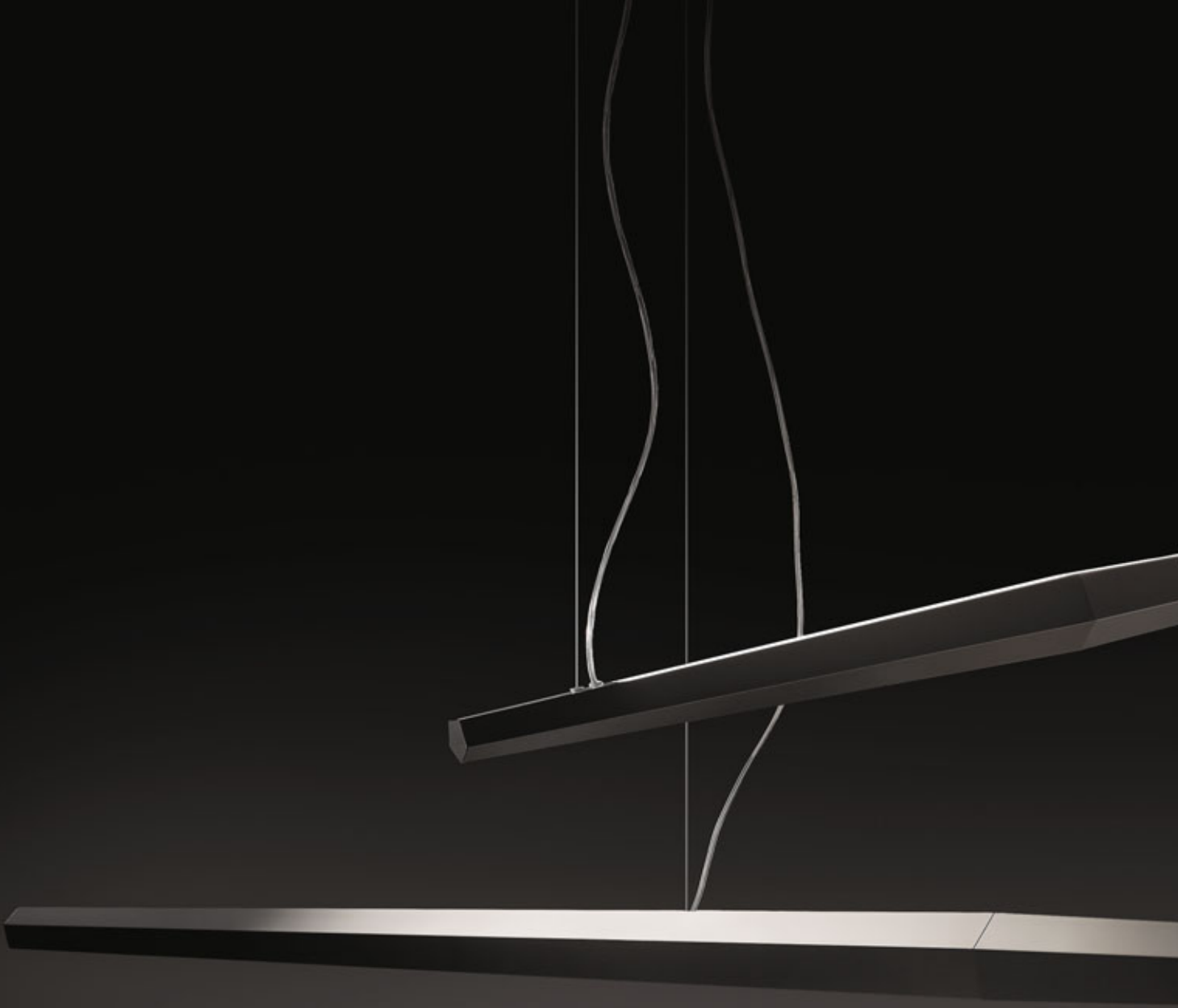











VIISI		Minelli - Fossati 2017		Registered Design		LED CE IP40	
		CODICE / CODE	CM A x B	H	INCHES A x B	H	FONTI LUMINOSE / LIGHT SOURCES
Sospensione / Suspension		L020__120.0102	120 x 7,4	7,1	47 3/7" x 3"	2 4/5"	Potenza assorbita apparecchio / Luminaire power consumption 23W Flusso luminoso apparecchio / Luminaire luminous flux 1502lm 3000K Ra80 220-240V DALI / PUSH DIM
			Cable lenght 200 / 78 4/5"				
		L021__120.0102	120 x 7,4	7,1	47 3/7" x 3"	2 4/5"	Potenza assorbita apparecchio / Luminaire power consumption 23W Flusso luminoso apparecchio / Luminaire luminous flux 1502lm 3000K Ra80 220-240V DALI / PUSH DIM
			Cable lenght 200 / 78 4/5"				
		L020__210.0102	210 x 7,4	7,1	82 3/4" x 3"	2 4/5"	Potenza assorbita apparecchio / Luminaire power consumption 44W Flusso luminoso apparecchio / Luminaire luminous flux 3004lm 3000K Ra80 220-240V DALI / PUSH DIM
			Cable lenght 200 / 78 4/5"				
		L021__210.0102	210 x 7,4	7,1	82 3/4" x 3"	2 4/5"	Potenza assorbita apparecchio / Luminaire power consumption 44W Flusso luminoso apparecchio / Luminaire luminous flux 3004lm 3000K Ra80 220-240V DALI / PUSH DIM
		Cable lenght 200 / 78 4/5"					
Terra / Floor		T020__210.0102	34,7 x 33,9	213	13 3/5" x 13"	84"	Potenza assorbita apparecchio / Luminaire power consumption 44W Flusso luminoso apparecchio / Luminaire luminous flux 3004lm 3000K Ra80 220-240V PUSH DIM

Fotometrie e Classi Energetiche disponibili www.panzeri.it / Photometric data and Energy Label available at www.panzeri.it

CODICI COLORI DISPONIBILI / COLOUR CODES AVAILABLE

DISPONIBILI A RICHIESTA LED 2700K / ON REQUEST 2700K LED AVAILABLE

01 Bianco
White

02 Nero
Black



ALDECIMO

Carmen Ferrara 2017

Il nome deriva dalla precisione necessaria per realizzarla. AlDecimo è una lampada che scompare ad incasso nella parete o nell'arredo, può essere rivestita e mimetizzarsi completamente nel contesto. Grazie a un meccanismo a pressione assume due diverse configurazioni. Quando è chiusa un driver bi-level regola automaticamente l'emissione al minimo e la luce disegna un sottile perimetro quadrato sulla superficie. In un tocco lo scenario cambia, con una leggera pressione della mano si sposta, fuoriesce e diffonde in radenza sulla parete. Finiture disponibili bianco e nero.

The name comes from the precision necessary to build it. AlDecimo is a limanire that disappears into wall or in furnitures, it can be covered and merge completely with the context. Thanks to a pressure mechanism it takes on two different configurations. When closed, a bi-level driver automatically adjusts the emission to a minimum level and the light draws a thin square perimeter on the surface. With a slight pressure of the hand it moves, the scenery easily changes, and it spreads light on the wall. White and black finishes available.



GERMAN
DESIGN
AWARD
WINNER
2019



ADI DESIGN INDEX 2019



reddot award 2018
honourable mention















ALDECIMO

Carmen Ferrara 2017

Registered Design

 **CE** IP20

CODICE / CODE	CM A x B	H	INCHES A x B	H	 MM	 INCHES	FONTI LUMINOSE / LIGHT SOURCES
Parete incasso Wall recessed  X02201.030.0112	29,4 x 29,4	7,7	11 3/8" x 11 3/8"	3"	29,5 x 29,5	11 5/8" x 11 5/8"	Potenza assorbita apparecchio / Luminaire power consumption 21W Flusso luminoso apparecchio / Luminaire luminous flux 933lm 3000K Ra80 220-240V BILEVEL

Fotometrie e Classi Energetiche disponibili www.panzeri.it / Photometric data and Energy Label available at www.panzeri.it

CODICI COLORI DISPONIBILI / COLOUR CODES AVAILABLE**01** Bianco
White

BROOKLYN ROUND

Enzo Panzeri 2017

Le infinite composizioni immaginabili con Brooklyn Round lo rendono un prodotto ideale per illuminare e stupire con giochi di equilibri e configurazioni miste di linee rette e curve, abbinato alla sospensione Brooklyn Line. Emissione di luce diretta con dimmerazione inserita nel rosone o in remoto, a sospensione e plafone. Disponibile un nuovo rosone per composizioni di più apparecchi, sia circolari che a semicerchio, da ordinare separatamente. Esempi di applicazioni sono visualizzabili nella sezione dedicata "Rosone per composizioni di Brooklyn Round". Bianco, nero e nuova finitura ottone satinato disponibili.

The endless compositions imaginable with Brooklyn Round make it a perfect product to enlight and amaze with games of balance and mixed configurations of straight lines and curves, combined with the Brooklyn Line suspension. Direct light emission with dimming in the canopy or placed remotely, in suspension and ceiling versions. New canopy for suspension of several elements is now available, both circular and semicircle shaped, to be ordered separately. Examples in the related paragraph "Canopy for configurations of Brooklyn Round". White, black and new mat brass finishes are available.





Freetime Sporting Club - Roma (IT) Courtesy of Spaceplanners
Photo credits Design Outfit











ROSONE PER COMPOSIZIONI BROOKLYN ROUND A PAGINA 154 / CANOPY FOR BROOKLYN ROUND CONFIGURATIONS AT PAGE 154

BROOKLYN ROUND

Enzo Panzeri 2017

LED CE IP40 850°

	CODICE / CODE	DEGREES	CM Ø	H	INCHES Ø	H	FONTI LUMINOSE / LIGHT SOURCES
Sospensione / Suspension	 L231__360.0102	360°	100	3,5	39 3/8"	1 3/8"	Potenza assorbita apparecchio / Luminaire power consumption 54W Flusso luminoso apparecchio / Luminaire luminous flux 2130lm 3000K Ra80 220-240V DALI / PUSH DIM
							Cable lenght 200 / 78 1/2"
	 L232__360.0102	360°	195	3,5	76 5/8"	1 3/8"	Potenza assorbita apparecchio / Luminaire power consumption 109W Flusso luminoso apparecchio / Luminaire luminous flux 4260lm 3000K Ra80 220-240V DALI / PUSH DIM
							Cable lenght 500 / 197"
Soffitto / Ceiling	 L231__180.0102	180°	100	3,5	39 3/8"	1 3/8"	Potenza assorbita apparecchio / Luminaire power consumption 29W Flusso luminoso apparecchio / Luminaire luminous flux 1065lm 3000K Ra80 220-240V DALI / PUSH DIM
							Cable lenght 200 / 78 1/2"
	 L232__180.0102	180°	195	3,5	76 5/8"	1 3/8"	Potenza assorbita apparecchio / Luminaire power consumption 54W Flusso luminoso apparecchio / Luminaire luminous flux 2130lm 3000K Ra80 220-240V DALI / PUSH DIM
							Cable lenght 500 / 197"
	XM231/232__L						Piastrina per raggruppamenti multipli Plate for multiple clusters

Fotometrie e Classi Energetiche disponibili www.panzeri.it / Photometric data and Energy Label available at www.panzeri.it

CODICI COLORI DISPONIBILI / COLOUR CODES AVAILABLE

DISPONIBILI A RICHIESTA LED 2700K / ON REQUEST 2700K LED AVAILABLE

- 01** Bianco
White
- 02** Nero
Black
- 19** Ottone satinato
Mat brass



NOVELTY

ROSONE PER COMPOSIZIONI BROOKLYN ROUND

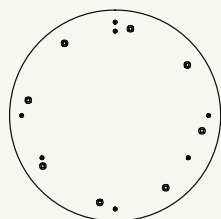

39,5
15 9/16"

NOVELTY

XM231__538.0099

Rosone per composizioni multiple di Brooklyn Round.

Può alloggiare al suo interno un numero massimo di 4 driver di diverse potenze, da 4x60W/24V DALI / PUSH DIM a 2x60W/24V+2x150W/24V DALI / PUSH DIM.

Può supportare il collegamento elettrico di massimo di 8 apparecchi e può portare massimo 7 cavi di sospensione.

Gli apparecchi Brooklyn Round vanno ordinati senza rosone e driver.

L'Ufficio Tecnico Panzeri è disponibile a supporto della progettazione.

Canopy for Brooklyn Round configurations. It carries a maximum of 4 drivers of different power: from 4 x60W/24V DALI / PUSH DIM to 2x60W/24V+2x150W/24V DALI / PUSH DIM.

It is able to feed maximum 8 fixtures and to sustain 7 suspension cables maximum.

Brooklyn Round fixtures have to be ordered without canopy and driver.

Panzeri Technical Department is available to support the design.

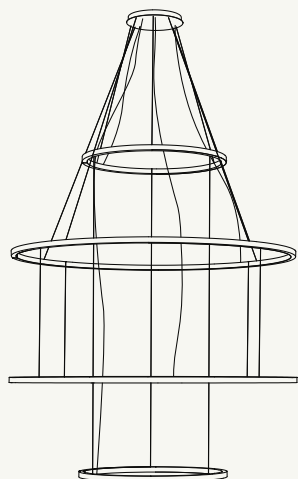

Esempio di composizione con 4 apparecchi:

Example of configuration with 4 fixtures:

N. 1 canopy XM231__538.0099

N.2 Brooklyn Round L232__360.0102 SPECIAL

N.2 Brooklyn Round L231__360.0102 SPECIAL



Esempio di composizione con 6 apparecchi:

Example of configuration with 6 fixtures:

N. 1 canopy XM231__538.0099

N.1 Brooklyn Round L232__360.0102 SPECIAL

N.2 Brooklyn Round L232__180.0102 SPECIAL

N.1 Brooklyn Round L231__360.0102 SPECIAL

N.2 Brooklyn Round L231__180.0102 SPECIAL

CANOPY FOR BROOKLYN ROUND CONFIGURATIONS

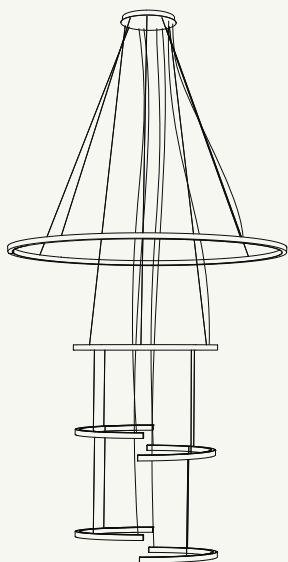

Esempio di composizione con 6 apparecchi:
Example of configuration with 6 fixtures:
N. 1 canopy XM231__538.0099
N.1 Brooklyn Round L232__360.0102 SPECIAL
N.1 Brooklyn Round L231__360.0102 SPECIAL
N.4 Brooklyn Round L231__180.0102 SPECIAL

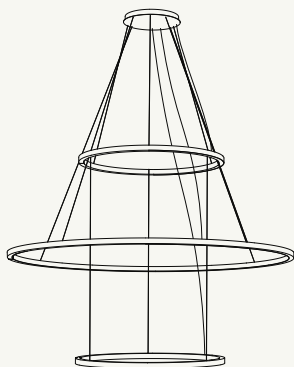

Esempio di composizione con 3 apparecchi:
Example of configuration with 3 fixtures:
N. 1 canopy XM231__538.0099
N.1 Brooklyn Round L232__360.0102 SPECIAL
N.2 Brooklyn Round L231__360.0102 SPECIAL

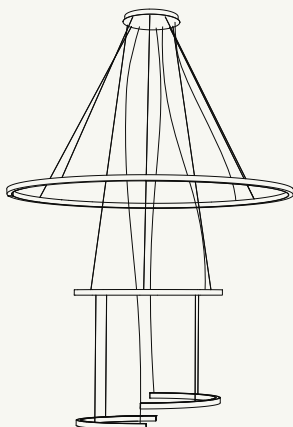

Esempio di composizione con 4 apparecchi:
Example of configuration with 4 fixtures:
N. 1 canopy XM231__538.0099
N.1 Brooklyn Round L232__360.0102 SPECIAL
N.1 Brooklyn Round L231__360.0102 SPECIAL
N.2 Brooklyn Round L231__180.0102 SPECIAL

Gli apparecchi Brooklyn Round vanno ordinati senza rosone e driver.
Brooklyn Round fixtures have to be ordered without canopy and driver.

L'Ufficio Tecnico Panzeri è disponibile a supporto della progettazione.
Panzeri Technical Department is available to support the design.

CODICI COLORI DISPONIBILI / COLOUR CODES AVAILABLE

01 Bianco
White

02 Nero
Black

19 Ottone satinato
Mat brass

BROOKLYN LINE

Enzo Panzeri 2013

Una linea semplice e allo stesso tempo caratterizzante, Brooklyn Line è una sospensione che si presta con facilità all'inserimento in molteplici ambienti. Il profilo in alluminio, ad emissione di luce diretta, ha una particolare finitura a coste. Disponibile estruso bianco e nero con schermo opale.

A simple as much as characterizing line, Brooklyn Line is a suspension that lends itself easily to enlight multiple environments. The aluminum profile, with direct light emission, has a special ribbed finish. Extruded white and black with opal diffuser available.









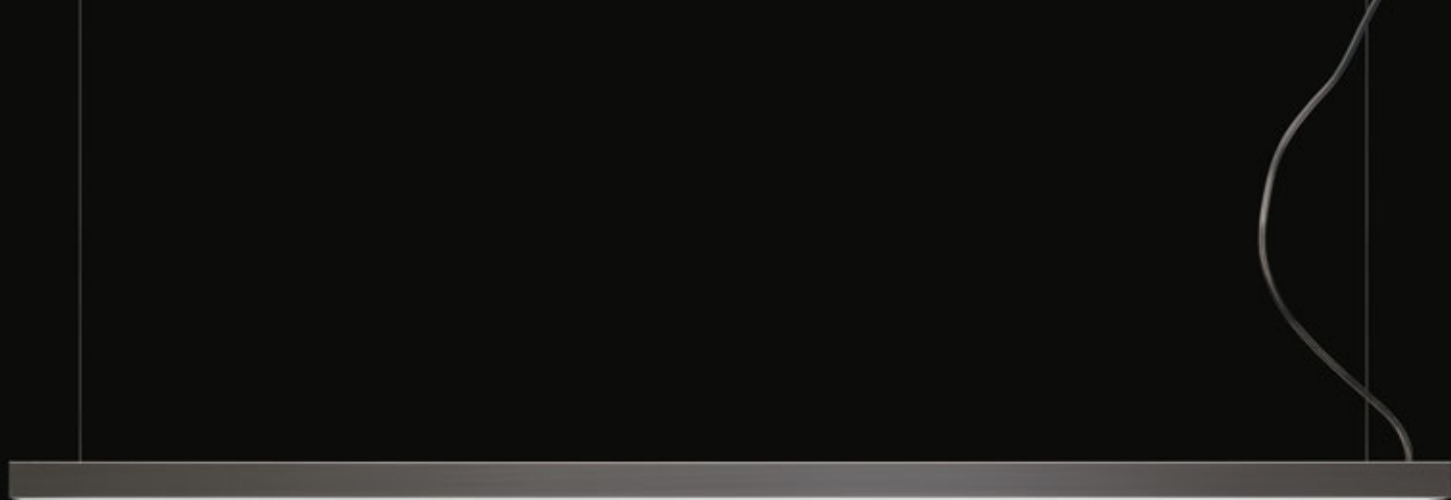

BROOKLYN LINE		Enzo Panzeri 2013			LED  CE IP20 850°	
	CODICE / CODE	CM A x B	H	INCHES A x B	H	FONTI LUMINOSE / LIGHT SOURCES
Sospensione / Suspension	L233__100.0101	102 x 3,5	3,5	40 1/8" x 1 3/8"	1 3/8"	Potenza assorbita apparecchio / Luminaire power consumption 20W Flusso luminoso apparecchio / Luminaire luminous flux 982lm 3000K Ra80 220-240V
		Cable lenght 200 / 78 4/5"				Con diffusore opale + riflettore / With opal diffuser + reflector
	L233__150.0101	152 x 3,5	3,5	59 9/16" x 1 3/8"	1 3/8"	Potenza assorbita apparecchio / Luminaire power consumption 29W Flusso luminoso apparecchio / Luminaire luminous flux 1473lm 3000K Ra80 220-240V
		Cable lenght 200 / 78 4/5"				Con diffusore opale + riflettore / With opal diffuser + reflector

Fotometrie e Classi Energetiche disponibili www.panzeri.it / Photometric data and Energy Label available at www.panzeri.it

CODICI COLORI DISPONIBILI / COLOUR CODES AVAILABLE

01 Bianco
White

02 Nero
Black



GIANO

Studio Tecnico Panzeri 2017

Tra i profili in alluminio estruso Giano si distingue per il design minimale e la grande flessibilità di utilizzo. Emissione di luce sia diretta che indiretta, disponibile nelle versioni parete e sospensione. Il Driver ON/OFF con accensione separata o DALI / PUSH DIM integrato, risolve ogni esigenza di installazione. Nella collezione "Profili" disponibili ulteriori varianti per composizioni su disegno ancora più libere. Bianco e nero le finiture disponibili. Schermo in policarbonato opale o microprismato per garantire un elevato comfort visivo negli ambienti di lavoro.

Among the extruded aluminum profiles, Giano stands out for its minimal design and great flexibility of use. Direct and indirect light emission, available in wall and suspension versions. ON/OFF with separate switching or integrated DALI / PUSH DIM driver solves all installation requirements. Check for further options in the "Profiles" collection, for even more flexible design compositions. Black and white finishes are available. Opal polycarbonate or microprismatic screen are available to guarantee high visual comfort in workplaces.















GIANO

Studio Tecnico Panzeri 2017

LED CE IP40

	CODICE / CODE	CM A x B	H	INCHES A x B	INCHES H	FONTI LUMINOSE / LIGHT SOURCES
Sospensione / Suspension	 L246__150.0101	152x4,2	9,8	59 5/8" x 1 3/8"	3 5/8"	Potenza assorbita apparecchio / Luminaire power consumption 77W Flusso luminoso apparecchio / Luminaire luminous flux 5521lm 3000K Ra80 220-240V Doppia accensione / Double switch
		Cable lenght 200 / 78 5/8"				
Inclusi 2 diffusori opali e uno microprismato 2 opal and 1 microprismatic diffuser included	 L246__150.0102	152x4,2	9,8	59 5/8" x 1 3/8"	3 5/8"	Potenza assorbita apparecchio / Luminaire power consumption 75W Flusso luminoso apparecchio / Luminaire luminous flux 5521lm 3000K Ra80 220-240V DALI / PUSH DIM
		Cable lenght 200 / 78 5/8"				
	 L246__200.0101	202x4,2	9,8	79 3/8" x 1 3/8"	3 5/8"	Potenza assorbita apparecchio / Luminaire power consumption 100W Flusso luminoso apparecchio / Luminaire luminous flux 7361lm 3000K Ra80 220-240V Doppia accensione / Double switch
		Cable lenght 200 / 78 5/8"				
	L246__200.0102	202x4,2	9,8	79 3/8" x 1 3/8"	3 5/8"	Potenza assorbita apparecchio / Luminaire power consumption 98W Flusso luminoso apparecchio / Luminaire luminous flux 7361lm 3000K Ra80 220-240V DALI / PUSH DIM
		Cable lenght 200 / 78 5/8"				



CODICI COLORI DISPONIBILI / COLOUR CODES AVAILABLE

• **47** Bianco + diffusori microprismatici
White + microprismatic diffusers

• **49** Nero + diffusori microprismatici
Black + microprismatic diffusers

• UGR < 19 in funzione delle condizioni di installazione
UGR < 19 depending on installation conditions



Parete / Wall	A246__025.0101	24x4,2	9,8	9 1/2" x 1 3/8"	3 5/8"	Potenza assorbita apparecchio / Luminaire power consumption 13W Flusso luminoso apparecchio / Luminaire luminous flux 746lm 3000K Ra80 220-240V
	A246__050.0101	52x4,2	9,8	20 1/2" x 1 3/8"	3 5/8"	Potenza assorbita apparecchio / Luminaire power consumption 26W Flusso luminoso apparecchio / Luminaire luminous flux 1493lm 3000K Ra80 220-240V
	A246__050.0102	52x4,2	9,8	20 1/2" x 1 3/8"	3 5/8"	Potenza assorbita apparecchio / Luminaire power consumption 26W Flusso luminoso apparecchio / Luminaire luminous flux 1493lm 3000K Ra80 220-240V DALI / PUSH DIM
Inclusi 2 diffusori opali 2 opal diffuser included	 A246__100.0101	102x4,2	9,8	40 1/8" x 1 3/8"	3 5/8"	Potenza assorbita apparecchio / Luminaire power consumption 52W Flusso luminoso apparecchio / Luminaire luminous flux 2985lm 3000K Ra80 220-240V Doppia accensione / Double switch
	A246__100.0102	102x4,2	9,8	40 1/8" x 1 3/8"	3 5/8"	Potenza assorbita apparecchio / Luminaire power consumption 50W Flusso luminoso apparecchio / Luminaire luminous flux 2985lm 3000K Ra80 220-240V DALI / PUSH DIM
	 A246__150.0101	152x4,2	9,8	59 5/8" x 1 3/8"	3 5/8"	Potenza assorbita apparecchio / Luminaire power consumption 77W Flusso luminoso apparecchio / Luminaire luminous flux 4477lm 3000K Ra80 220-240V Doppia accensione / Double switch
	A246__150.0102	152x4,2	9,8	59 5/8" x 1 3/8"	3 5/8"	Potenza assorbita apparecchio / Luminaire power consumption 75W Flusso luminoso apparecchio / Luminaire luminous flux 4477lm 3000K Ra80 220-240V DALI / PUSH DIM

Fotometrie e Classi Energetiche disponibili www.panzeri.it / Photometric data and Energy Label available at www.panzeri.it

CODICI COLORI DISPONIBILI / COLOUR CODES AVAILABLE

46 Bianco + diffusori opali
White + opal diffusers

48 Nero + diffusori opali
Black + opal diffusers



TO-BE

Enzo Panzeri 2017

Un cilindro puro, disponibile in tre dimensioni. To-be attrae per la semplicità delle linee e nasconde piccoli quanto preziosi dettagli, come lo schermo arretrato e l'elevata resa cromatica CRI>90. Si presta facilmente ad installazioni singole e composizioni miste. Il formato da 450mm è disponibile sia a sospensione che a plafone. A progetto per entrambe le versioni è possibile richiedere ottiche da 25 e 48 gradi in alternativa alla standard di 40 gradi. Bianco, nero gommato, decorato a mano in foglia oro, bronzo e ottone satinato le finiture disponibili.

A pure cylinder, which comes in three sizes. To-be attracts for the simplicity of the lines and hides as small as precious details, such as the back screen and the high color rendering index CRI>90. It lends easily to single installations and mixed compositions. The 450mm size is available both in suspension and surface-mounted version, for specific design projects it is possible to request 25 and 48 degrees optics as an alternative to the standard 40 degrees beam angle. White, rubber black, hand-made decorated in golden leaf, bronze or mat brass finishes are available.











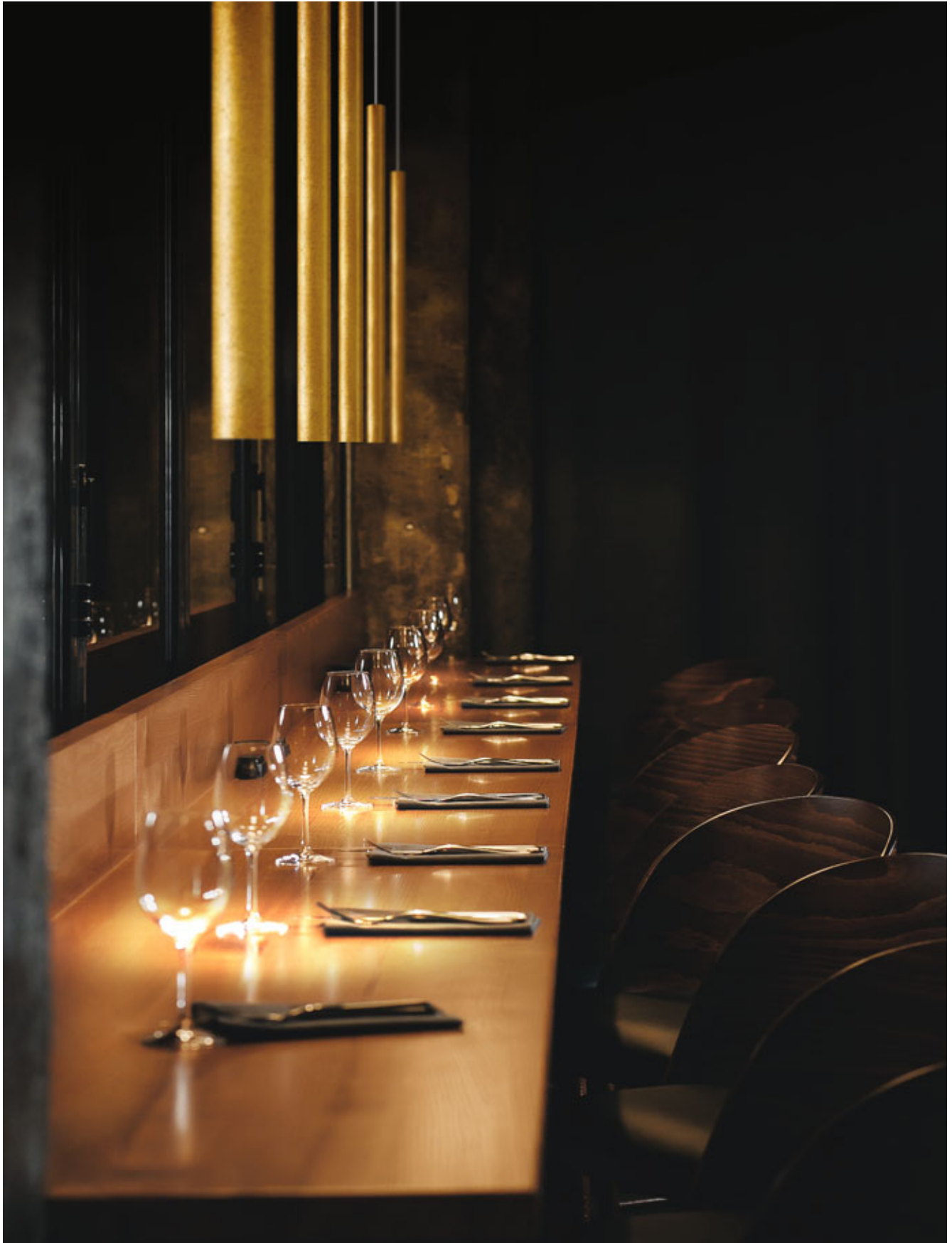

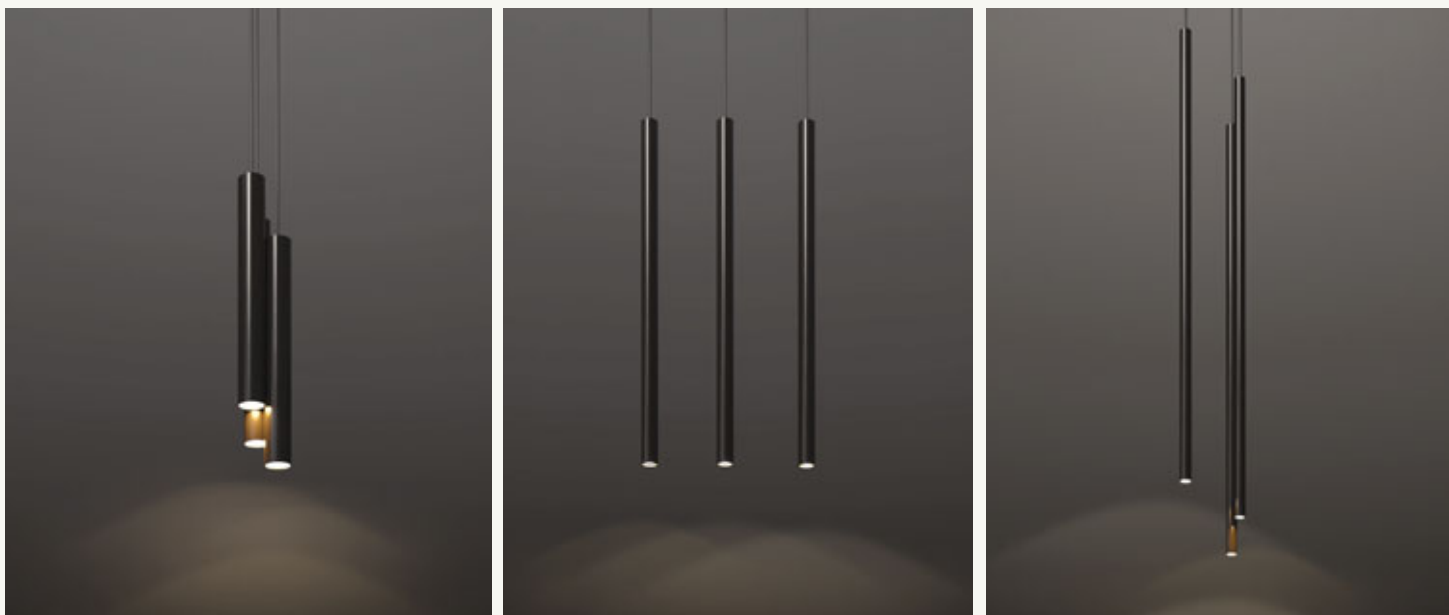





ROSONI E DECENTRAMENTI A PAGINA 352 / OFFSET AND CANOPIES PAGE 352

TO-BE

Enzo Panzeri 2017

LED CE IP20     Suspension no canopy 24V)

	CODICE / CODE	CM Ø	H	INCHES Ø	H	FONTI LUMINOSE / LIGHT SOURCES
Sospensione / Suspension	L025_..085.0501	2,2	85	7/8"	33 1/2"	Potenza assorbita apparecchio / Luminaire power consumption 4W Flusso luminoso apparecchio / Luminaire luminous flux 181lm 2700K Ra90 220-240V
			Cable lenght 200 / 78 5/8"			
	L026_..065.0501	3,2	65	1 1/4"	25 3/8"	Potenza assorbita apparecchio / Luminaire power consumption 7W Flusso luminoso apparecchio / Luminaire luminous flux 363lm 2700K Ra90 220-240V
			Cable lenght 200 / 78 5/8"			
	L027_..045.1701*	5,5	45	2 1/8"	17 3/4"	Potenza assorbita apparecchio / Luminaire power consumption 10W Flusso luminoso apparecchio / Luminaire luminous flux 836lm 2700K Ra90 FL 40° 220-240V
			Cable lenght 200 / 78 5/8"			
Sospensione no rosone / no driver Suspension no canopy / no driver	M025_..085.0510	2,2	85	7/8"	33 1/2"	Potenza assorbita apparecchio / Luminaire power consumption 2,8W Flusso luminoso apparecchio / Luminaire luminous flux 181lm 2700K Ra90 24V DC
			Cable lenght 200 / 78 5/8"			
	M026_..065.0510	3,2	65	1 1/4"	25 3/8"	Potenza assorbita apparecchio / Luminaire power consumption 5,3W Flusso luminoso apparecchio / Luminaire luminous flux 363lm 2700K Ra90 24V DC
			Cable lenght 200 / 78 5/8"			
Soffitto / Ceiling	P027_..045.1701*	5,5	45	2 1/8"	17 3/4"	Potenza assorbita apparecchio / Luminaire power consumption 10W Flusso luminoso apparecchio / Luminaire luminous flux 836lm 2700K Ra90 FL 40° 220-240V

Fotometrie e Classi Energetiche disponibili www.panzeri.it / Photometric data and Energy Label available at www.panzeri.it

*Per progetti a richiesta ottiche a 25° e 48° / For project, beam angles 25°, 48° on request

CODICI COLORI DISPONIBILI / COLOUR CODES AVAILABLE

01 Bianco
White

04 Nero gommato
Rubber black

17 Bronzo
Bronze

19 Ottone satinato
Mat brass

21 Foglia oro
Gold leaf



NOVELTY

NOVELTY

OLIVIA EMMA CLIO

Silvia Poma 2015/2017

Una famiglia di lampade a sospensione realizzate in vetro soffiato. Inaspettati giochi di luce e riflessioni nascono dalla finitura a coste dal gusto retrò del diffusore. Il dialogo tra Olivia, Emma e Clio si arricchisce di significati nella ricerca di un equilibrio perfetto tra combinazioni cromatiche ed installazioni singole o multiple. Cristallo, acciaio, ambra, bronzo, tabacco, verde e bianco lucido le colorazioni vetro disponibili, nero o ottone satinato le finiture del rosone e degli accessori. Lampadina a filamento LED inclusa nella fornitura.

A family of blown glass suspensions lamps. Unexpected games of light and reflections come from the ribbed finish in a retro style. The dialogue between Olivia, Emma and Clio is filled with meanings in the search for a perfect balance between color combinations and single or multiple installations. Crystal, steel, amber, bronze, tobacco, green and glossy white glass colors are available, black or mat brass finishes for canopy and accessories. LED filament bulb included in the supply.















Dotata di un sistema di aggancio multiplo a soffitto dei corpi illuminanti che permette una grande componibilità.

Equipped with a system for attaching multiple ceiling lighting fixtures that allows for great modularity.

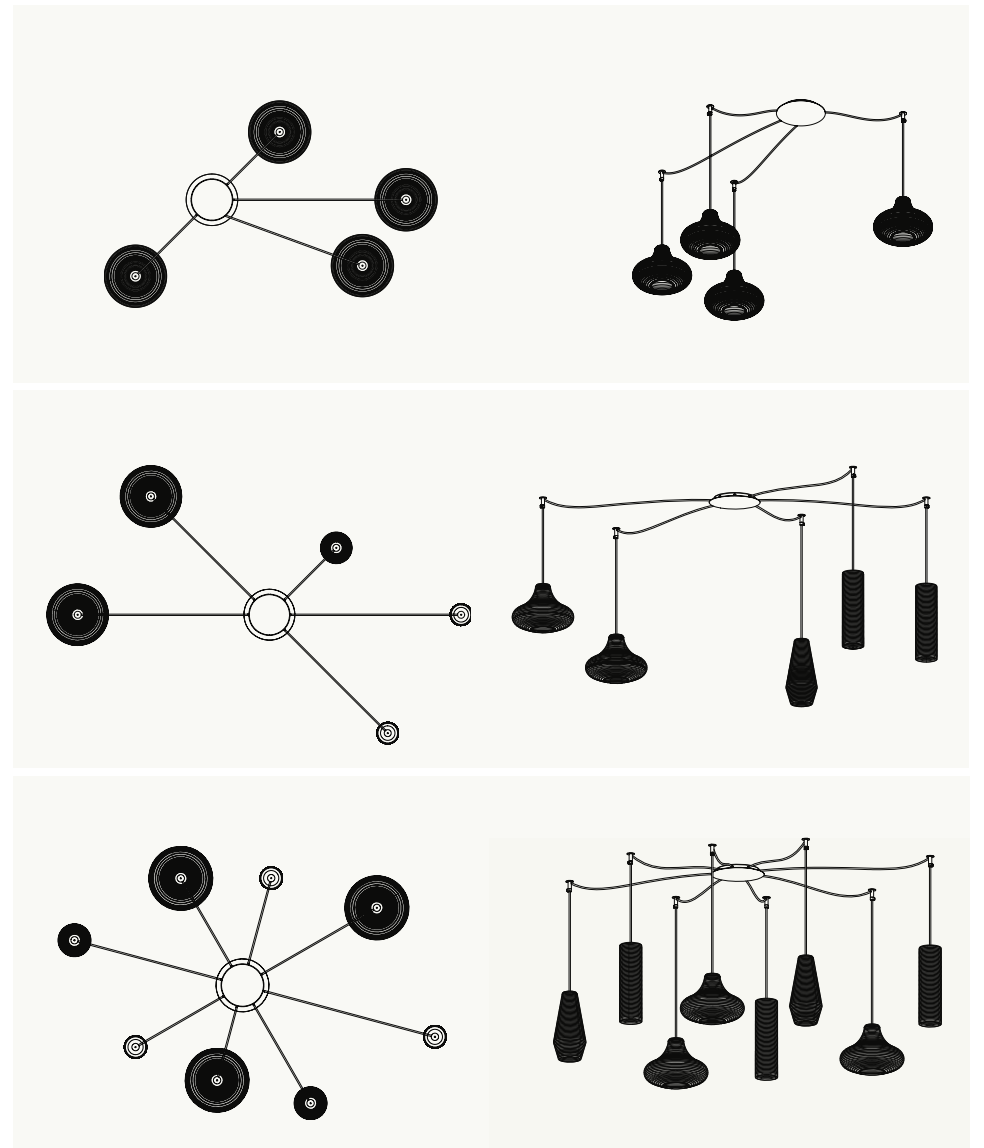



ROSONI E DECENTRAMENTI A PAGINA 352 / OFFSET AND CANOPIES PAGE 352













OLIVIA, EMMA&CLIO

Silvia Poma 2015/17

Registered Design

LED CE IP20 

FONTI LUMINOSE / LIGHT SOURCES

	CODICE / CODE	CM Ø	H	INCHES Ø	H	LED	HALO	
Olivia Sospensione / Suspension	L097___.000.0200	13	27,4	5 1/8"	10 4/8"	Incl. LED bulb 8W E27 2700K Ra80 1050lm  Not dimmable	Max 57W E27 	
	Cable lenght 350 / 138"							
	M097___.000.0200	13	27,4	5 1/8"	10 4/8"	Incl. LED bulb 8W E27 2700K Ra80 1050lm  Not dimmable	Max 57W E27 	
	No rosone / No canopy	Cable lenght 350 / 138" + polycarbonate hook						
	M91/94/97__	21	4	8 3/8"	1 1/8"	Rosone max 8+1 uscite Canopy max 8+1 output		
	M800	Appendimento in polycarbonato per sospensione Polycarbonate hook for suspension						
Emma Sospensione / Suspension	L091___.000.0200	26	18,5	10 1/4"	7 7/8"	Incl. LED bulb 8W E27 2700K Ra80 1050lm  220-240V Not dimmable	Max 57W E27 	
	Cable lenght 350 / 138"							
	M091___.000.0200	26	18,5	10 1/4"	7 7/8"	Incl. LED bulb 8W E27 2700K Ra80 1050lm  220-240V Not dimmable	Max 57W E27 	
	No rosone / No canopy	Cable lenght 350 / 138" + polycarbonate hook						
	M91/94/97__	21	4	8 3/8"	1 1/8"	Rosone max 8+1 uscite Canopy max 8+1 output		
	M800	Appendimento in polycarbonato per sospensione Polycarbonate hook for suspension						
Clio Sospensione / Suspension	L094___.000.0200	8,5	31	3 1/8"	12 1/8"	Incl. LED bulb 8W E27 2700K Ra80 1050lm  220-240V Not dimmable	Max 57W E27 	
	Cable lenght 350 / 138"							
	M094___.000.0200	8,5	31	3 1/8"	12 1/8"	Incl. LED bulb 8W E27 2700K Ra80 1050lm  220-240V Not dimmable	Max 57W E27 	
	No rosone / No canopy	Cable lenght 350 / 138" + polycarbonate hook						
	M91/94/97__	21	4	8 3/8"	1 1/8"	Rosone max 8+1 uscite Canopy max 8+1 output		
	M800	Appendimento in polycarbonato per sospensione Polycarbonate hook for suspension						

Fotometrie e Classi Energetiche disponibili www.panzeri.it / Photometric data and Energy Label available at www.panzeri.it

CODICI COLORI DISPONIBILI / COLOUR CODES AVAILABLE

0 2 Nero / Bianco
Black / White

1 9 Ottone satinato
Mat brass



NOVELTY

CODICI COLORI DISPONIBILI / COLOUR CODES AVAILABLE

5 1 Nero / Bianco
Black / White

5 2 Nero / Cristallo
Black / Crystal

5 3 Nero / Acciaio
Black / Steel

5 4 Nero / Ambra
Black / Amber

5 5 Nero / Bronzo
Black / Bronze

5 6 Nero / Tabacco
Black / Tobacco

5 7 Nero / Verde
Black / Green

7 1 Ottone satinato /
Bianco
Mat brass / White

7 2 Ottone satinato /
Cristallo
Mat brass / Crystal

7 3 Ottone satinato /
Acciaio
Mat brass / Steel

7 4 Ottone satinato /
Ambra
Mat brass / Amber

7 5 Ottone satinato /
Bronzo
Mat brass / Bronze

7 6 Ottone satinato /
Tabacco
Mat brass / Tobacco

7 7 Ottone satinato /
Verde
Mat brass / Green



JACKIE

Enzo Panzeri 2015

Dietro il minimalismo delle superfici, sofisticati congegni a snodo e a tirante compongono il sistema di regolazione della testa e del braccio di Jackie. Apparecchio da tavolo, terra, parete (con braccio o senza), parete/soffitto, spot a binario. La versione da tavolo può essere fornita con base di appoggio, morsetto o perno di fissaggio al piano. L'elegante testa in pressofusione di alluminio è caratterizzata dal diffusore in policarbonato con perimetro luminoso e doppia serigrafia appositamente studiata per ottimizzare il fascio e ridurre l'abbagliamento. La scelta del modulo LED garantisce massima qualità della luce con CRI>90, dimmerabile tramite comando STEP DIM a 5 regolazioni di intensità luminosa (eccetto versioni da parete/soffitto e da binario), ideale per l'illuminazione delle scrivanie negli uffici. Bianco, nero, rosso, titanio e ottone satinato le finiture disponibili.

Behind the minimalism of the surfaces, sophisticated joints and rods make up the Jackie head and arm adjustment system. Table, floor, wall (with or without bracket), wall/ceiling and track spot lighting fixtures are available. The table version can be supplied with standard base, clamp or fixing pin to the surface. The elegant die-cast aluminum head features a diffuser in polycarbonate with a luminous perimeter and double screen serigraphy, specifically designed to optimize the light beam and reduce glare. The choice of LED module guarantees maximum quality of light with CRI>90, dimmable by STEP DIM control with 5 light intensity settings (except for wall/ceiling and track versions), ideal for lighting desks in offices. White, black, red, titanium and mat brass finishes are available.













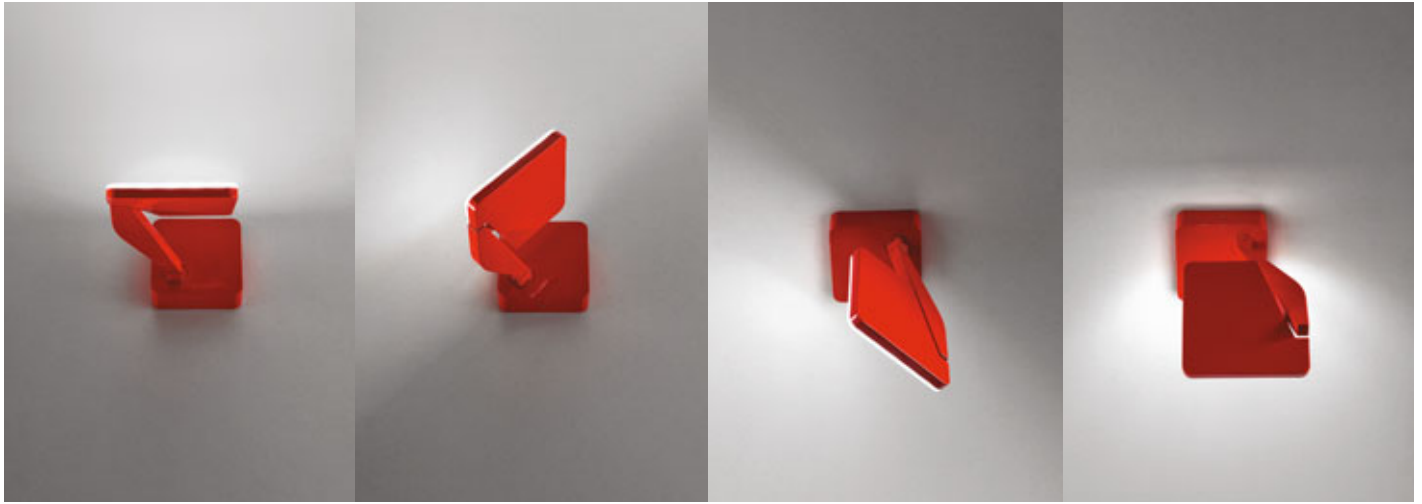



JACKIE

Enzo Panzeri 2015

Registered Design

LED CE IP40 (⊕ - A/P/B077_ _)

	CODICE / CODE	CM A x B	H	INCHES A x B	H	POTENZA ASSORBITA APPARECCHIO / LUMINAIRE POWER CONSUMPTION 10W FLUSSO LUMINOSO APPARECCHIO / LUMINAIRE LUMINOUS FLUX 526lm 3000K Ra90 220-240V STEP DIM
Tavolo / Table	C077_ _ .000.0409	59 x 17,5	54	23 ¼" x 6 ¾"	21 ¾"	Potenza assorbita apparecchio / Luminaire power consumption 10W Flusso luminoso apparecchio / Luminaire luminous flux 526lm 3000K Ra90 220-240V STEP DIM
Tavolo morsetto / Table clamp	CM077_ _ .000.0409	59 x 10,5	53	23 ¼" x 4 ½"	20 7/8"	Potenza assorbita apparecchio / Luminaire power consumption 10W Flusso luminoso apparecchio / Luminaire luminous flux 526lm 3000K Ra90 220-240V STEP DIM
Tavolo perno / Table pin	CP077_ _ .000.0409	59 x 10,5	53	23 ¼" x 4 ½"	20 7/8"	Potenza assorbita apparecchio / Luminaire power consumption 10W Flusso luminoso apparecchio / Luminaire luminous flux 526lm 3000K Ra90 220-240V STEP DIM
Braccio parete / Wall bracket	CA077_ _ .000.0409	59 x 10,5	54	23 ¼" x 4 ½"	21 ¾"	Potenza assorbita apparecchio / Luminaire power consumption 10W Flusso luminoso apparecchio / Luminaire luminous flux 526lm 3000K Ra90 220-240V STEP DIM
Terra / Floor	T077_ _ .000.0409	59 x 23	128	23 ¼" x 9"	50 ¾"	Potenza assorbita apparecchio / Luminaire power consumption 10W Flusso luminoso apparecchio / Luminaire luminous flux 526lm 3000K Ra90 220-240V STEP DIM
Faretto parete / Wall spot	A077_ _ .000.0409	20 x 10,5	8,5	7 7/8" x 4 ½"	3 ½"	Potenza assorbita apparecchio / Luminaire power consumption 10W Flusso luminoso apparecchio / Luminaire luminous flux 526lm 3000K Ra90 220-240V STEP DIM
Faretto parete-soffitto / Wall ceiling spot <input type="checkbox"/>	P077_ _ .000.0101	20 x 10,5	8,5	7 7/8" x 4 ½"	3 ½"	Potenza assorbita apparecchio / Luminaire power consumption 8,5W Flusso luminoso apparecchio / Luminaire luminous flux 702lm 3000K Ra80 220-240V
LED Spotlight per binario / Spotlight for electrified track	B077_ _ .000.0101	26 x 10,5		10 ¼" x 4 ½"		Potenza assorbita apparecchio / Luminaire power consumption 8,5W Flusso luminoso apparecchio / Luminaire luminous flux 702lm 3000K Ra80 220-240V

Fotometrie e Classi Energetiche disponibili www.panzeri.it / Photometric data and Energy Label available at www.panzeri.it

CODICI COLORI DISPONIBILI / COLOUR CODES AVAILABLE

01 Bianco
White

02 Nero
Black

03 Rosso
Red

19 Ottone satinato
Mat brass

30 Titanio
Titanium



JACKIE IoT

Enzo Panzeri 2015

Dalla ricerca di sistemi innovativi di gestione del comfort e di risparmio energetico negli uffici nasce OTOMO, sistema di Building Automation che interagisce con Jackie IoT tramite bluetooth consentendo il rilevamento di presenza, l'accensione programmata, la misura della luminosità, della temperatura e dell'umidità all'interno dell'ambiente. Scaricando "OTOMO APP" è possibile visualizzare i dati e impostare i parametri di luminosità desiderata, oltre che gestire altri dispositivi smart presenti all'interno della rete mesh. Jackie IoT è disponibile in versione tavolo con base di appoggio, morsetto o perno di fissaggio al piano; versione con braccio a parete e versione terra. Bianco, nero, rosso, titanio e ottone satinato le finiture disponibili.

Born from the search for innovative systems for comfort management and energy saving in offices, OTOMO is a Building Automation system that interacts with Jackie IoT via bluetooth and allows the detection of presence, programming on/off cycle, brightness, temperature and humidity measurements in any environment. By downloading "OTOMO APP" you can view data and set the desired brightness parameters, as well as manage other smart devices detected in the mesh network. Jackie IoT is available in table version with standard base, clamp or fixing pin to the surface; wall version with bracket and floor versions. White, black, red, titanium and mat brass finishes are available.



JACKIE IoT

Enzo Panzeri 2015

LED CE IP40 (⊕ - A077)

	CODICE / CODE	CM A x B	H	INCHES A x B	H	FONTE LUMINOSE / LIGHT SOURCES
Tavolo / Table	C077___.000.0413	59 x 17,5	54	23 1/4" x 6 7/8"	21 3/8"	Potenza assorbita apparecchio / Luminaire power consumption 10W Flusso luminoso apparecchio / Luminaire luminous flux 526lm 3000K Ra90 220-240V IoT STEP DIM
Tavolo morsetto / Table clamp	CM077___.000.0413	59 x 10,5	53	23 1/4" x 4 1/2"	20 7/8"	Potenza assorbita apparecchio / Luminaire power consumption 10W Flusso luminoso apparecchio / Luminaire luminous flux 526lm 3000K Ra90 220-240V IoT STEP DIM
Tavolo perno / Table pin	CP077___.000.0413	59 x 10,5	53	23 1/4" x 4 1/2"	20 7/8"	Potenza assorbita apparecchio / Luminaire power consumption 10W Flusso luminoso apparecchio / Luminaire luminous flux 526lm 3000K Ra90 220-240V IoT STEP DIM
Braccio parete / Wall bracket	CA077___.000.0413	59 x 10,5	54	23 1/4" x 4 1/2"	21 3/8"	Potenza assorbita apparecchio / Luminaire power consumption 10W Flusso luminoso apparecchio / Luminaire luminous flux 526lm 3000K Ra90 220-240V IoT STEP DIM
Terra / Floor	T077___.000.0413	59 x 23	128	23 1/4" x 9"	50 3/8"	Potenza assorbita apparecchio / Luminaire power consumption 10W Flusso luminoso apparecchio / Luminaire luminous flux 526lm 3000K Ra90 220-240V IoT STEP DIM
Faretto parete / Wall spot	A077___.000.0413	20 x 10,5	8,5	7 7/8" x 4 1/2"	3 1/2"	Potenza assorbita apparecchio / Luminaire power consumption 10W Flusso luminoso apparecchio / Luminaire luminous flux 526lm 3000K Ra90 220-240V IoT STEP DIM

Fotometrie e Classi Energetiche disponibili www.panzeri.it / Photometric data and Energy Label available at www.panzeri.it

CODICI COLORI DISPONIBILI / COLOUR CODES AVAILABLE

01 Bianco
White

02 Nero
Black

03 Rosso
Red

19 Ottone satinato
Mat brass

30 Titanio
Titanium



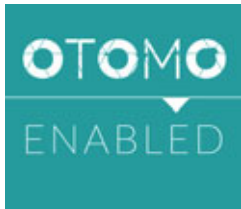

COS'È

OTOMO è un network di controlli bluetooth nato per gestire l'ottimizzazione, il risparmio energetico e il controllo dell'ufficio tramite smartphone e dispositivi mobili.

EFFICIENTE Installazione veloce e prodotto affidabile. Nessuna logica da programmare: abbiamo pensato a tutto noi.

PROFESSIONALE Guidato dall'esperienza nella building automation ideato da specialisti, per professionisti.

TECHNOLOGY DRIVEN Internet of Things, Domotica, Cloud, Risparmio, Controllo, Gestione aziendale. Finalmente, il valore è aggiunto.

COMPREHENSIVE Tutto quello che serve, senza intoppi.

OTOMO è un sistema ideato per gestire il comfort ed il risparmio energetico degli uffici. Si basa sul **RICONOSCIMENTO DELLA PRESENZA DI UN UTENTE IN UN AMBIENTE per ottimizzare la gestione della luce, compiere azioni automatiche per produrre risparmio energetico, controllare i parametri ambientali e climatici.** La tecnologia usata è il Bluetooth Low Energy (BLE). Si sfrutta la rete mesh generata dal sistema per rilevare un utente dotato di un dispositivo mobile bluetooth Apple o Android.

COSA CONTROLLA

Gestione automatica - e/o relazionata alla presenza dell'utente - di:

LUCE
TAPPARELLE E VARCHI
RAFFREDDAMENTO / RISCALDAMENTO
MOTORIZZAZIONI

- Verifica dei parametri di luminosità degli ambienti
- Controllo e regolazione della luminosità costante attraverso sensori di luminosità posti sul tavolo di lavoro
- Apertura/chiusura e controllo delle lamelle di veneziane per ottimizzare i consumi energetici
- Spegnimento automatico delle zone
- Gestione della luce biodinamica e del ciclo circadiano

OTOMO È APP

Ogni automatismo può essere variato immediatamente, passando al controllo manuale tramite l'APP [iOS o Android] che può

VISUALIZZARE:
luminosità dell'ambiente
temperatura locale

umidità relativa
stato dei colleghi (libero/occupato)
e **CONTROLLARE** luci, tapparelle, veneziane, termoregolazioni, varchi. Anche da remoto.

OTOMO È CLOUD

I prodotti comunicano con una infrastruttura Cloud in grado di rielaborare dati, fornire reports, gestire gli utenti del sistema, consentire il controllo da remoto dei sistemi e il loro aggiornamento.

Controllo remoto dell'impianto
Notifiche presenza utenti in aree non autorizzate/giorni festivi
Funzioni di alert presenza relative a gruppi di lavoro

WHAT IS

OTOMO is a network of bluetooth controls born to manage optimization, energy saving and office control through smartphone and mobile devices.

EFFICIENT Fast installation, reliable products. No logic to be set up, we thought of everything for you.

PROFESSIONAL Driven from wide experience in building automation, designed from specialists for professionals.

TECHNOLOGY DRIVEN Internet of Things, Domotics, Cloud, Savings, Control, Company management. The added value, finally.

COMPREHENSIVE Everything you need, no hitches & glitches.

OTOMO is a system designed to optimize comfort and energy saving in office buildings. It works detecting the **PRESENCE OF A USER IN AN ENVIRONMENT and consequently managing lighting, energy saving, environmental and climatic parameters.**

The technology used is Bluetooth Low Energy (BLE) along with a MESH network generated by the system to detect users equipped with an Apple or Android mobile device.

WHAT IT CONTROLS

Automatic and/or presence-dependent management of:

LIGHTING
BLINDS AND GATES
COOLING / HEATING
AUTOMATIONS

- Lux metering
- Control and constant brightness dimming through lux meters installed on the work table
- Energy savings thanks to time and daylight-dependent shading control
- Automatic zones shutdown
- Management of biodynamic light

OTOMO IS APP

Each automated control can be immediately changed, switching to manual control using the APP [iOS or Android] which can

DISPLAY:
room brightness
room temperature
relative humidity
colleagues status (free/busy)
and **CONTROL** lights, blinds, shades, temperature controls, gates. Even remotely

OTOMO IS CLOUD

The devices communicate with a cloud infrastructure reprocessing data, providing reports, managing users and allowing remote updating and monitoring.

Remote installation control
Users presence alerts for non authorised areas or during public holiday
Alert associated to the presence of Working Group generated in the OTOMO's app

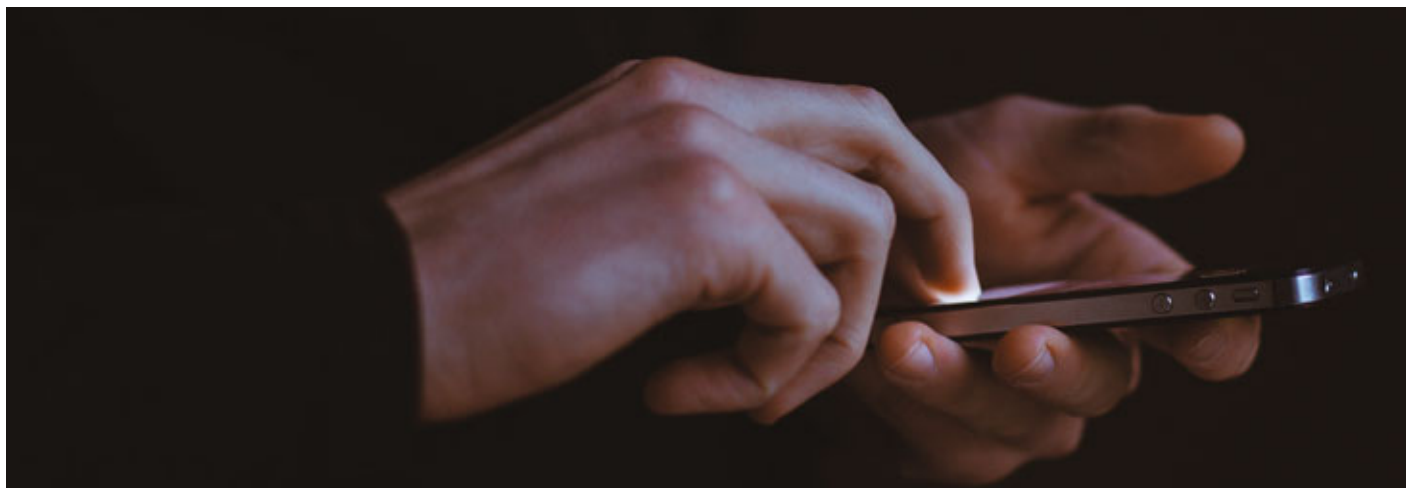

TECNOLOGIA

BLUETOOTH LOW ENERGY - BLE

Il Bluetooth è uno standard per le comunicazioni wireless. La tecnologia Bluetooth è fortemente impiegata per trasferire informazioni tra due o più dispositivi "vicini" (range 30m).

Bluetooth Low Energy - BLE (noto anche come Bluetooth Smart) è uno sviluppo della tecnologia Bluetooth ed ha come caratteristica più importante l'ulteriore riduzione dei consumi richiesti per il trasferimento dei dati.

La tecnologia Bluetooth non richiede una rete Wi-Fi attiva nè nessun cablaggio, la frequenza del BLE è uguale in tutte le aree geografiche del mondo e garantisce un alto livello di crittografia e protezione oltre ad una compatibilità impareggiabile per dispositivi mobili, smartphones, tablet.

DALI – DIGITAL ADDRESSABLE LIGHTING INTERFACE

DALI è lo standard internazionale (IEC 62386) specifico per l'illuminazione, adottato da diversi costruttori di reattori elettronici:

- accettato universalmente
- può connettere fino a 64 dispositivi ECG (Electronic Control Gear)
- cablaggio semplificato su bus dedicato
- controllo broadcast di tutti gli ECG

TECHNOLOGY

BLUETOOTH LOW ENERGY - BLE

Bluetooth is an international standard for wireless communications. The Bluetooth technology is widely used to transfer information between two or more devices in the neighborhood (range 30m).

Bluetooth Low Energy - BLE (also known as Bluetooth Smart) is an evolution of Bluetooth technology and its most important feature is the further reduction of the power consumption required for data transfer.

Bluetooth doesn't require an operating Wi-fi network, any cabling, BLE's frequency is equal in every geographical area of the world, and is assuring high level of cryptography and protection together with unpaired compatibility to mobile devices, smart-phones, tablets.

DALI – DIGITAL ADDRESSABLE LIGHTING INTERFACE

DALI is the lighting international standard adopted by several manufacturers of electronic control gears.

- universally accepted
- it can connect up to 64 devices ECG (Electronic Control Gear)
- simplified wiring on a dedicated bus
- broadcast control of all ECGs



RINGS COLLECTION

Enzo Panzeri 2015/2016

La collezione Rings è composta da una serie di anelli in alluminio con caratteristiche che si differenziano sia per formato che per tipologia di diffusione della luce, mono o biemissione. La varietà di soluzioni combinabili ne consente l'applicazione in ambienti di ogni genere, dal residenziale ai grandi spazi pubblici. Bianco, nero e decorato a mano con foglia oro le finiture disponibili, colori e dimensioni custom a richiesta.

The Rings collection consists of a series of aluminum rings with features that differ both in the size and in the type of lighting diffusion, with single or double emission. The variety of combinations allows its application in all kinds of environments, from residential to large public spaces. White, black and hand decorated with gold leaf finishes are available, colors and custom sizes on request.



RINGS COLLECTION

GOLDEN RING

Enzo Panzeri 2015

Golden Ring è l'anello più versatile della Rings collection, pensato per raggiungere elevate prestazioni e grandi diametri. L'emissione di luce combinata diretta/indiretta e la dimmerazione DALI / PUSH DIM di serie (L081_ _080.0108 solo emissione diretta e no DALI) offrono qualità della luce e versatilità per composizioni multiple di più apparecchi. Bianco, nero e decorato a mano con foglia oro le finiture disponibili, colori e dimensioni custom a richiesta.

Golden Ring is the most versatile lighting fixture of the Rings collection, designed to achieve high performance and to reach large diameters. Direct/indirect combined lighting emission and the DALI / PUSH DIM driver (L081_ _080.0108 direct and no DALI emission only) offer quality of light and versatility for multiple compositions of several elements. White, black and hand-made decorated in golden leaf finishes are available, colors and custom sizes on request.













Oslo National Library (NO). Courtesy of SML Lighting AS



Town Hall of Waalre (NL) Courtesy of Architect Burobas
Photo credits Bart Van Overbeeke

GOLDEN RING

Enzo Panzeri 2015

Registered Design

LED CE IP40 850°

	CODICE / CODE	CM Ø	H	INCHES Ø	H	FONTI LUMINOSE / LIGHT SOURCES
Sospensione / Suspension	L081_..080.0108	ext. 78 / int. 56	15	ext. 30 3/4" / int. 22"	6"	Potenza assorbita apparecchio / Luminaire power consumption 47W Flusso luminoso apparecchio / Luminaire luminous flux 3823lm 3000K Ra80 220-240V
	☐ Direct light	Cable length 200 / 78 1/2"				
	L081_..080.0102	ext. 78 / int. 56	15	ext. 30 3/4" / int. 22"	6"	Potenza assorbita apparecchio / Luminaire power consumption 92W Flusso luminoso apparecchio / Luminaire luminous flux 3823+3823lm 3000K Ra80 220-240V DALI / PUSH DIM
	☐ Direct light/Indirect light	Cable length 200 / 78 1/2"				
	L081_..120.0102	ext. 123 / int. 102	15	ext. 48 3/8" / int. 40 1/8"	6"	Potenza assorbita apparecchio / Luminaire power consumption 156W Flusso luminoso apparecchio / Luminaire luminous flux 6553+6553lm 3000K Ra80 220-240V DALI / PUSH DIM
	☐ Direct light/Indirect light	Cable length 500 / 197"				
	L081_..180.0102	ext. 183 / int. 161	15	ext. 72 1/8" / int. 63 3/8"	6"	Potenza assorbita apparecchio / Luminaire power consumption 230W Flusso luminoso apparecchio / Luminaire luminous flux 9830+9830lm 3000K Ra80 220-240V DALI / PUSH DIM
	☐ Direct light/Indirect light	Cable length 500 / 197"				
	M81_..-3	20		7 7/8"		Rosone opzionale per raggruppamento cavi acciaio (Ø 80-120-180) Optional canopy to join steel cables (Ø 80-120-180)
	L081_..300.0102**	ext. 301 / int. 279	15	ext. 118 3/8" / int. 110"	6"	Potenza assorbita apparecchio / Luminaire power consumption 394W Flusso luminoso apparecchio / Luminaire luminous flux 16383+16383lm 3000K Ra80 220-240V DALI / PUSH DIM
	☐ Direct light/Indirect light	Cable length 500 / 197"				
	M81_..-6	30		11 5/8"		Rosone opzionale per raggruppamento cavi acciaio (Ø 300) Optional canopy to join steel cables (Ø 300)

** Fixture in 2 parts to compose

Fotometrie e Classi Energetiche disponibili www.panzeri.it / Photometric data and Energy Label available at www.panzeri.it

CODICI COLORI DISPONIBILI / COLOUR CODES AVAILABLE

01 Bianco
White

02 Nero
Black

21 Foglia oro
Gold leaf

DISPONIBILI A RICHIESTA LED 2700K / ON REQUEST 2700K LED AVAILABLE

DISPONIBILI A RICHIESTA LED 4000K / ON REQUEST 4000K LED AVAILABLE



RINGS COLLECTION

SILVER RING

Enzo Panzeri 2016

Silver Ring è un anello perfetto che conserva in una dimensione compatta tutta la funzionalità del fratello maggiore Golden Ring. Tante le possibilità di combinazione dei quattro formati disponibili. Equipaggiato con tecnologia LED DALI / PUSH DIM ad emissione di luce diretta sia nella versione a sospensione che nella variante parete/soffitto, frutto di un attento studio dei pesi e fornito di un accessorio che ne semplifica l'installazione. La versatilità di applicazione di questo prodotto lo rende adatto alle più svariate esigenze di illuminazione, il design essenziale nasconde in sé la nostra costante ricerca di innovazione. Bianco, nero, bronzo e decorato a mano in foglia oro le finiture disponibili.

Silver Ring is a perfect ring that preserves in a compact design all the functionality of his brother Golden Ring. So many possibilities for combining the four available sizes. Equipped with LED DALI / PUSH DIM technology with direct light emission both in suspension and in wall/ceiling versions, the result of a careful study of weights provided with an accessory that simplifies installation. The versatility of application of this product makes it suitable for the most different lighting needs, the essential design hides our constant search for innovation. White, black, bronze or hand-made decorated in golden leaf finishes are available.























SILVER RING

Enzo Panzeri 2016

LED CE IP40 850°

	CODICE / CODE	CM Ø	H	INCHES Ø	H	FONTI LUMINOSE / LIGHT SOURCES
Sospensione / Suspension	L082__050.0102	ext. 54 / int. 33	8	ext. 21 3/4" / int. 13"	3 1/2"	Potenza assorbita apparecchio / Luminaire power consumption 25W Flusso luminoso apparecchio / Luminaire luminous flux 2265lm 3000K Ra80 220-240V DALI / PUSH DIM
	 Direct light	Cable length 200 / 78 1/2"				
	L082__080.0102	ext. 78 / int. 56	8	ext. 30 3/4" / int. 22"	3 1/2"	Potenza assorbita apparecchio / Luminaire power consumption 47W Flusso luminoso apparecchio / Luminaire luminous flux 3823lm 3000K Ra80 220-240V DALI / PUSH DIM
	 Direct light	Cable length 200 / 78 1/2"				
	L082__120.0102	ext. 123 / int. 102	8	ext. 48 2/3" / int. 40 1/2"	3 1/2"	Potenza assorbita apparecchio / Luminaire power consumption 79W Flusso luminoso apparecchio / Luminaire luminous flux 6553lm 3000K Ra80 220-240V DALI / PUSH DIM
 Direct light	Cable length 500 / 197"					
L082__180.0102	ext. 183 / int. 161	8	ext. 72 1/2" / int. 63 3/4"	3 1/2"	Potenza assorbita apparecchio / Luminaire power consumption 115W Flusso luminoso apparecchio / Luminaire luminous flux 9830lm 3000K Ra80 220-240V DALI / PUSH DIM	
 Direct light	Cable length 500 / 197"					
Soffitto-parete / Ceiling-wall	 P082__050.0102	ext. 54 / int. 33	8	ext. 21 3/4" / int. 13"	3 1/2"	Potenza assorbita apparecchio / Luminaire power consumption 25W Flusso luminoso apparecchio / Luminaire luminous flux 2265lm 3000K Ra80 220-240V DALI / PUSH DIM
	 P082__080.0102	ext. 78 / int. 56	8	ext. 30 3/4" / int. 22"	3 1/2"	Potenza assorbita apparecchio / Luminaire power consumption 47W Flusso luminoso apparecchio / Luminaire luminous flux 3823lm 3000K Ra80 220-240V DALI / PUSH DIM
	 P082__120.0102	ext. 123 / int. 102	8	ext. 48 2/3" / int. 40 1/2"	3 1/2"	Potenza assorbita apparecchio / Luminaire power consumption 79W Flusso luminoso apparecchio / Luminaire luminous flux 6553lm 3000K Ra80 220-240V DALI / PUSH DIM
	 P082__180.0102	ext. 183 / int. 161	8	ext. 72 1/2" / int. 63 3/4"	3 1/2"	Potenza assorbita apparecchio / Luminaire power consumption 115W Flusso luminoso apparecchio / Luminaire luminous flux 9830lm 3000K Ra80 220-240V DALI / PUSH DIM

Fotometrie e Classi Energetiche disponibili www.panzeri.it / Photometric data and Energy Label available at www.panzeri.it

CODICI COLORI DISPONIBILI / COLOUR CODES AVAILABLE

DISPONIBILI A RICHIESTA LED 2700K / ON REQUEST 2700K LED AVAILABLE

01 Bianco / White
02 Nero / Black
17 Bronzo / Bronze
21 Foglia oro / Gold leaf

DISPONIBILI A RICHIESTA LED 4000K / ON REQUEST 4000K LED AVAILABLE



NOVELTY

PLANET RING

Studio Tecnico Panzeri 2016

A sospensione, parete, soffitto e incasso, Planet Ring è un apparecchio che soddisfa contemporaneamente esigenze di illuminazione diffusa e di un'elevata emissione luminosa, disponibile anche con dimmerazione DALI / PUSH DIM o con luce d'emergenza. Il design è pensato per agevolare l'accesso alla componentistica elettronica on board grazie al fissaggio magnetico dello schermo diffusore e al sistema di ancoraggio rapido della scheda LED. Finitura in bianco, colori custom a richiesta.

Suspension, wall, ceiling and recessed lighting fixture, Planet Ring is a device that simultaneously meets the needs of diffused lighting and high lumen output, also available with DALI / PUSH DIM dimmer or emergency light. The design is conceived to facilitate access to electronic components on board thanks to the magnetic fixing of the screen diffuser and to the fast anchoring system of the LED board. White finish is available, custom colors on request.









PLANET RING

Studio Tecnico Panzeri 2016

LED CE IP40 850°

	CODICE / CODE	CM Ø	H	INCHES Ø	H	FONTI LUMINOSE / LIGHT SOURCES
Soffitto / Ceiling	P08301.040.0101	41	9	16 1/8"	3 3/8"	Potenza assorbita apparecchio / Luminaire power consumption 28,6W Flusso luminoso apparecchio / Luminaire luminous flux 2315lm 3000K Ra80 220-240V
	P08301.040.0102 DALI / PUSH DIM					
	P08301.040.0107 1H/12H EMERGENCY					
	P08301.070.0101	65	9	25 3/8"	3 3/8"	Potenza assorbita apparecchio / Luminaire power consumption 75W Flusso luminoso apparecchio / Luminaire luminous flux 6173lm 3000K Ra80 220-240V
	P08301.070.0102 DALI / PUSH DIM					
	P08301.070.0107 1H/12H EMERGENCY					
Sospensione / Suspension	P08301.100.0101	95	9	37 3/8"	3 3/8"	Potenza assorbita apparecchio / Luminaire power consumption 139W Flusso luminoso apparecchio / Luminaire luminous flux 12345lm 3000K Ra80 220-240V
	P08301.100.0102 DALI / PUSH DIM					
	P08301.100.0107 1H/12H EMERGENCY					
	L08301.070.0101	65	9	25 3/8"	3 3/8"	Potenza assorbita apparecchio / Luminaire power consumption 75W Flusso luminoso apparecchio / Luminaire luminous flux 6173lm 3000K Ra80 220-240V
	L08301.070.0102 DALI / PUSH DIM			Cable length 200 / 78 1/2"		
	L08301.070.0107 1H/12H EMERGENCY					
Incasso / Recessed	L08301.100.0101	95	9	37 3/8"	3 3/8"	Potenza assorbita apparecchio / Luminaire power consumption 139W Flusso luminoso apparecchio / Luminaire luminous flux 12345lm 3000K Ra80 220-240V
	L08301.100.0102 DALI / PUSH DIM			Cable length 200 / 78 1/2"		
	L08301.100.0107 1H/12H EMERGENCY					
	X08301.040.0101	43	9	17"	3 3/8"	Potenza assorbita apparecchio / Luminaire power consumption 28,6W Flusso luminoso apparecchio / Luminaire luminous flux 2315lm 3000K Ra80 220-240V
	X08301.040.0102 DALI / PUSH DIM					
	X08301.040.0107 1H/12H EMERGENCY					
Incasso / Recessed	X08301.070.0101	67	9	26 3/8"	3 3/8"	Potenza assorbita apparecchio / Luminaire power consumption 75W Flusso luminoso apparecchio / Luminaire luminous flux 6173lm 3000K Ra80 220-240V
	X08301.070.0102 DALI / PUSH DIM					
	X08301.070.0107 1H/12H EMERGENCY					
	X08301.100.0101	98	9	38 3/8"	3 3/8"	Potenza assorbita apparecchio / Luminaire power consumption 139W Flusso luminoso apparecchio / Luminaire luminous flux 12345lm 3000K Ra80 220-240V
	X08301.100.0102 DALI / PUSH DIM					
	X08301.100.0107 1H/12H EMERGENCY					

Fotometrie e Classi Energetiche disponibili www.panzeri.it / Photometric data and Energy Label available at www.panzeri.it

CODICI COLORI DISPONIBILI / COLOUR CODES AVAILABLE

DISPONIBILI A RICHIESTA LED 4000K / ON REQUEST 4000K LED AVAILABLE

01 Bianco
White



ONE

Studio Tecnico Panzeri 2010

One è un tubo di luce disponibile a sospensione e a soffitto. Versatile nella sua applicazione, a seconda della scelta cromatica può caratterizzare fortemente gli ambienti o scomparire con neutralità nel bianco del soffitto. Bianco, nero, decorato a mano con foglia oro, bronzo e ottone satinato le finiture disponibili.

One is a light tube available in suspension and ceiling versions. Versatile in its application, depending on the color choice it can strongly characterize the rooms or disappear with neutrality in the ceiling. White, black, hand-made decorated in golden leaf, bronze and mat brass finishes are available.









ROSONI E DECENTRAMENTI A PAGINA 352 / OFFSET AND CANOPIES PAGE 352

ONE	Studio Tecnico Panzeri 2010					 CE IP40
	CODICE / CODE	CM Ø	H	INCHES Ø H		FONTI LUMINOSE / LIGHT SOURCES
Sospensione / Suspension	L037___.000.0101	10,5	38	4 1/8"	15"	Potenza assorbita apparecchio / Luminaire power consumption 15W Flusso luminoso apparecchio / Luminaire luminous flux 1097lm 3000K Ra80 220-240V
				Cable length 200 / 78 1/2"		
Sospensione / Suspension	L037___.000.0102	10,5	38	4 1/8"	15"	Potenza assorbita apparecchio / Luminaire power consumption 15W Flusso luminoso apparecchio / Luminaire luminous flux 1097lm 3000K Ra80 220-240V DALI / PUSH DIM
				Cable length 200 / 78 1/2"		
Soffitto / Ceiling	P037___.000.0101	10,5	21	4 1/8"	8 1/4"	Potenza assorbita apparecchio / Luminaire power consumption 15W Flusso luminoso apparecchio / Luminaire luminous flux 1097lm 3000K Ra80 220-240V
Soffitto / Ceiling	P037___.000.0102	10,5	21	4 1/8"	8 1/4"	Potenza assorbita apparecchio / Luminaire power consumption 15W Flusso luminoso apparecchio / Luminaire luminous flux 1097lm 3000K Ra80 220-240V DALI / PUSH DIM

Fotometrie e Classi Energetiche disponibili www.panzeri.it / Photometric data and Energy Label available at www.panzeri.it

CODICI COLORI DISPONIBILI / COLOUR CODES AVAILABLE

01 Bianco White	02 Nero Black	17 Bronzo Bronze	19 Ottone satinato Mat brass	21 Foglia oro Gold leaf
---------------------------	-------------------------	----------------------------	--	-----------------------------------



NOVELTY

NOVELTY

TWO

Studio Tecnico Panzeri 2010

Geometrie che si parlano, in Two il diffusore circolare ed il cubo del corpo lampada creano un binomio indissolubile. Disponibile nella versione a sospensione e a soffitto. A seconda della scelta cromatica può caratterizzare fortemente gli ambienti o scomparire con neutralità nel bianco del soffitto. Bianco, nero, decorato a mano con foglia oro, bronzo e ottone satinato le finiture disponibili. Accessorio per esigenze di dimmerazione ordinabile separatamente.

Geometries that talk to each other, the circular diffuser of Two and the cube of the lamp body create an indissoluble pair. Suspension and ceiling versions are available. Depending on the color choice it can strongly characterize the rooms or disappear with neutrality in the ceiling. White, black, hand-made decorated in golden leaf, bronze and mat brass finishes are available. Accessory for dimming needs to be ordered separately.











ROSONI E DECENTRAMENTI A PAGINA 352 / OFFSET AND CANOPIES PAGE 352

TWO	Studio Tecnico Panzeri 2010					 CE IP40
	CODICE / CODE	CM A x B	H	INCHES A x B H		FONTI LUMINOSE / LIGHT SOURCES
Sospensione / Suspension	L038_000.0106	8 x 8	38	3 1/8" x 3 1/8"	15"	Potenza assorbita apparecchio / Luminaire power consumption 10W Flusso luminoso apparecchio / Luminaire luminous flux 630lm 3000K Ra80 220-240V
		Cable length 200 / 78 3/4"				
Soffitto / Ceiling	P038_000.0106	8 x 8	8,7	3 1/8" x 3 1/8"	3 1/2"	Potenza assorbita apparecchio / Luminaire power consumption 10W Flusso luminoso apparecchio / Luminaire luminous flux 630lm 3000K Ra80 220-240V
Accessorio dimmerabile Dimming device	XM14/230	5,1 x 3,2	1,8	2" x 1 1/4"	5/8"	Dimmer per moduli LED a 230V 5÷100W/ Dimmer for 230V 5÷100W LED modules

Fotometrie e Classi Energetiche disponibili www.panzeri.it / Photometric data and Energy Label available at www.panzeri.it

CODICI COLORI DISPONIBILI / COLOUR CODES AVAILABLE

01 Bianco White **02** Nero Black **17** Bronzo Bronze **19** Ottone satinato Mat brass **21** Foglia oro Gold leaf



NOVELTY

NOVELTY

THREE

Studio Tecnico Panzeri 2010

Cubo dal design minimale con diffusore in vetro satinato, disponibile nelle versioni soffitto e parete. A seconda della scelta cromatica Three può caratterizzare gli ambienti ed attrarre lo sguardo o scomparire integrandosi totalmente al contesto. Bianco, nero, bronzo e ottone satinato le finiture disponibili. Accessorio per esigenze di dimmerazione ordinabile separatamente.

A Cube with a minimal design and satin glass diffuser, is available in ceiling and wall versions. Depending on the color choice, Three can characterize the environments and attract the eye or disappear completely integrating into the context. Black, white, bronze and mat brass finishes are available. Accessory for dimming needs to be ordered separately.







THREE

Studio Tecnico Panzeri 2011

Registered Design

  IP40

	CODICE / CODE	CM A x B	H	INCHES A x B	H	FONTI LUMINOSE / LIGHT SOURCES
Soffitto-parete / Ceiling-wall	 P039_..011.0106	11 x 11	11	4 1/8" x 4 1/8"	4 1/8"	Potenza assorbita apparecchio / Luminaire power consumption 10W Flusso luminoso apparecchio / Luminaire luminous flux 630lm 3000K Ra80 220-240V
	 P039_..015.0106	15 x 15	15	6" x 6"	6"	Potenza assorbita apparecchio / Luminaire power consumption 15W Flusso luminoso apparecchio / Luminaire luminous flux 1012lm 3000K Ra80 220-240V
Accessorio dimmerabile Dimming device	XM14/230	5,1 x 3,2	1,8	2" x 1 1/4"	5/8"	Dimmer per moduli LED a 230V 5÷100W/ Dimmer for 230V 5÷100W LED modules

Fotometrie e Classi Energetiche disponibili www.panzeri.it / Photometric data and Energy Label available at www.panzeri.it

CODICI COLORI DISPONIBILI / COLOUR CODES AVAILABLE

01 Bianco
White

02 Nero
Black

17 Bronzo
Bronze

19 Ottone satinato
Mat brass



NOVELTY

NOVELTY

TOY

Highlight 2007

Toy è un apparecchio a parete, disponibile in cinque diverse lunghezze, adatto ad installazioni singole e in composizioni di più elementi. Un blocco ad emissione di luce diretta e indiretta con meccanismo elastico che consente di nascondere le viti, a conferma dell'attenzione che diamo al dettaglio anche più piccolo. Bianco, decorato a mano in foglia oro, acciaio lucido, acciaio satinato, bronzo e ottone satinato le finiture disponibili.

Toy is a wall luminaire, it comes in five different lengths, suitable for single installations and multiple compositions. A block with direct and indirect light emission with an elastic mechanism that conceals the screws, confirming the attention we give to the even smallest detail. White, hand-made decorated in golden leaf, polished steel, mat stainless steel, bronze and mat brass finishes are available.









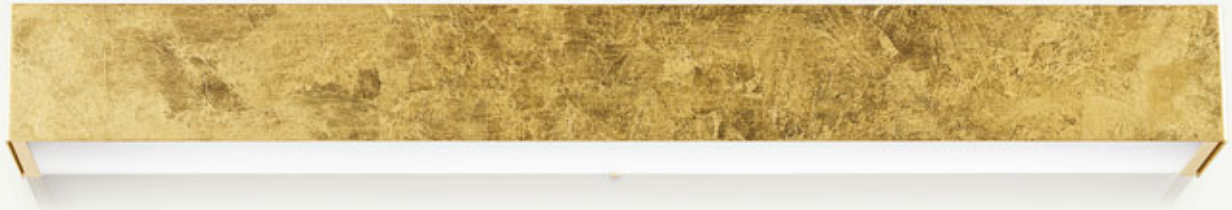

TOY		Highlight 2007				LED CE IP20
	CODICE / CODE	CM A x B	H	INCHES A x B	H	FONTI LUMINOSE / LIGHT SOURCES
Parete / Wall	A016__007.0000	7,5 x 8,5	7,5	3" x 3 1/4"	3"	LED retrofit bulb G9 Lmax. 60mm - Ø max. 17,5mm max 48W G9
	A016__025.0101	25 x 8,5	7	9 7/8" x 3 1/4"	2 3/4"	Potenza assorbita apparecchio / Luminaire power consumption 13W Flusso luminoso apparecchio / Luminaire luminous flux 938lm 3000K Ra80 220-240V
	A016__025.0102	25 x 8,5	7	9 7/8" x 3 1/4"	2 3/4"	Potenza assorbita apparecchio / Luminaire power consumption 13W Flusso luminoso apparecchio / Luminaire luminous flux 938lm 3000K Ra80 220-240V DALI / PUSH DIM
	A016__045.0101	45,5 x 8,5	7	18" x 3 1/4"	2 3/4"	Potenza assorbita apparecchio / Luminaire power consumption 24W Flusso luminoso apparecchio / Luminaire luminous flux 1876lm 3000K Ra80 220-240V
	A016__045.0102	45,5 x 8,5	7	18" x 3 1/4"	2 3/4"	Potenza assorbita apparecchio / Luminaire power consumption 24W Flusso luminoso apparecchio / Luminaire luminous flux 1876lm 3000K Ra80 220-240V DALI / PUSH DIM
	A016__060.0101	61 x 8,5	7	24" x 3 1/4"	2 3/4"	Potenza assorbita apparecchio/Luminaire power consumption 35W Flusso luminoso apparecchio / Luminaire luminous flux 2814lm 3000K Ra80 220-240V
	A016__060.0102	61 x 8,5	7	24" x 3 1/4"	2 3/4"	Potenza assorbita apparecchio/Luminaire power consumption 35W Flusso luminoso apparecchio / Luminaire luminous flux 2814lm 3000K Ra80 220-240V DALI / PUSH DIM
	A016__090.0101	88,5 x 8,5	7	34 7/8" x 3 1/4"	2 3/4"	Potenza assorbita apparecchio/Luminaire power consumption 45W Flusso luminoso apparecchio / Luminaire luminous flux 3752lm 3000K Ra80 220-240V
	A016__090.0102	88,5 x 8,5	7	34 7/8" x 3 1/4"	2 3/4"	Potenza assorbita apparecchio/Luminaire power consumption 45W Flusso luminoso apparecchio / Luminaire luminous flux 3752lm 3000K Ra80 220-240V DALI / PUSH DIM

Fotometrie e Classi Energetiche disponibili www.panzeri.it / Photometric data and Energy Label available at www.panzeri.it

CODICI COLORI DISPONIBILI / COLOUR CODES AVAILABLE

01 Bianco
White

17 Bronzo
Bronze

19 Ottone satinato
Mat brass

21 Foglia oro
Gold leaf

37 Acciaio inox lucido
Polished stainless
steel

39 Acciaio inox satinato
Mat stainless steel



NOVELTY



NOVELTY



TOY GYPSO

Highlight 2011

Toy Gypso è un apparecchio a parete in gesso disponibile in due diverse lunghezze. Ad emissione di luce diretta e indiretta, la luce è l'unica protagonista degli ambienti in cui questa lampada si nasconde. Toy Gypso può essere tinteggiata o rivestita come la parete, integrandosi perfettamente con essa.

Toy Gypso is a plaster wall fixture which comes in two different lengths. With direct and indirect light emission, only light is protagonist in environments in which this lamp hides. Toy Gypso could be painted or covered like walls, perfectly integrating with it.





TOY GYPSO

Highlight 2011

  IP20

	CODICE / CODE	CM A x B	H	INCHES A x B	H	FONTI LUMINOSE / LIGHT SOURCES
Parete / Wall	A01642.025.0101	27 x 9,5	8,5	10 ½" x 3 ¾"	3 ¼"	Potenza assorbita apparecchio / Luminaire power consumption 13W Flusso luminoso apparecchio / Luminaire luminous flux 938lm 3000K Ra80 220-240V
	A01642.025.0102	27 x 9,5	8,5	10 ½" x 3 ¾"	3 ¼"	Potenza assorbita apparecchio / Luminaire power consumption 13W Flusso luminoso apparecchio / Luminaire luminous flux 938lm 3000K Ra80 220-240V DALI / PUSH DIM
	A01642.060.0101	61 x 9,5	8,5	24" x 3 ¾"	3 ¼"	Potenza assorbita apparecchio / Luminaire power consumption 35W Flusso luminoso apparecchio / Luminaire luminous flux 2814lm 3000K Ra80 220-240V
	A01642.060.0102	61 x 9,5	8,5	24" x 3 ¾"	3 ¼"	Potenza assorbita apparecchio / Luminaire power consumption 35W Flusso luminoso apparecchio / Luminaire luminous flux 2814lm 3000K Ra80 220-240V DALI / PUSH DIM

Fotometrie e Classi Energetiche disponibili www.panzeri.it / Photometric data and Energy Label available at www.panzeri.it

CODICI COLORI DISPONIBILI / COLOUR CODES AVAILABLE

DISPONIBILI A RICHIESTA LED 2700K / ON REQUEST 2700K LED AVAILABLE

4 2 Gesso
Plaster



APP

Q² 2013

Un'onda che incontra la parete e la illumina di luce indiretta. L'eleganza di questo estruso in alluminio nasconde nelle sue dimensioni contenute la tecnologia LED più avanzata e l'ingegnosità del fissaggio con grani a scomparsa. App è un apparecchio di illuminazione disponibile in due formati. Bianco, titanio e ottone satinato le finiture disponibili. Accessorio per esigenze di dimmerazione ordinabile separatamente.

A wave that meets the wall and illuminates with indirect light. The elegance of this extruded aluminum hides in its small dimensions the most advanced LED technology and the ingeniousness of fixing with hidden grains. App comes in two dimensions. White, titanium and mat brass finishes are available. Accessory for dimming needs to be ordered separately.







APP	Q2 2013						LED CE IP20
	CODICE / CODE	CM A x B	H	INCHES A x B	H	FONTI LUMINOSE / LIGHT SOURCES	
Parete / Wall	A098_001.0106	12 x 20	20	4 3/4" x 7 3/4"	7 3/4"	Potenza assorbita apparecchio / Luminaire power consumption 17W Flusso luminoso apparecchio / Luminaire luminous flux 1510lm 3000K Ra80 220-240V	
	A098_002.0106	24 x 20	20	9 1/2" x 7 3/4"	7 3/4"	Potenza assorbita apparecchio / Luminaire power consumption 34W Flusso luminoso apparecchio / Luminaire luminous flux 3020lm 3000K Ra80 220-240V	
Accessorio dimmerabile Dimming device	XM14/230	5,1 x 3,2	1,8	2" x 1 1/4"	5/8"	Dimmer per moduli LED a 230V 5÷100W / Dimmer for 230V 5÷100W LED modules	

Fotometrie e Classi Energetiche disponibili www.panzeri.it / Photometric data and Energy Label available at www.panzeri.it

CODICI COLORI DISPONIBILI / COLOUR CODES AVAILABLE

DISPONIBILI A RICHIESTA LED 2700K / ON REQUEST 2700K LED AVAILABLE

01 Bianco
White

19 Ottone satinato
Mat brass

30 Titanio
Titanium



NOVELTY

KUBIK

Studio Tecnico Panzeri 2001

La semplicità di un cubo in vetro opale satinato che porta in sé il valore dell'arte della soffiatura. Kubik è disponibile nelle versioni sospensione, tavolo, soffitto e parete. A scelta la tipologia di sorgente varia tra LED, E27, E14. La versione a sospensione ha una tige telescopica che consente di regolarne il posizionamento a diverse altezze.

The simplicity of a frosted opal glass cube that brings with it the value of the art of blowing. Kubik is available in suspension, table, ceiling and wall versions. LED, E27 or E14 lighting source are available. The suspension version has a telescopic tige that allows it to be adjusted to different heights.





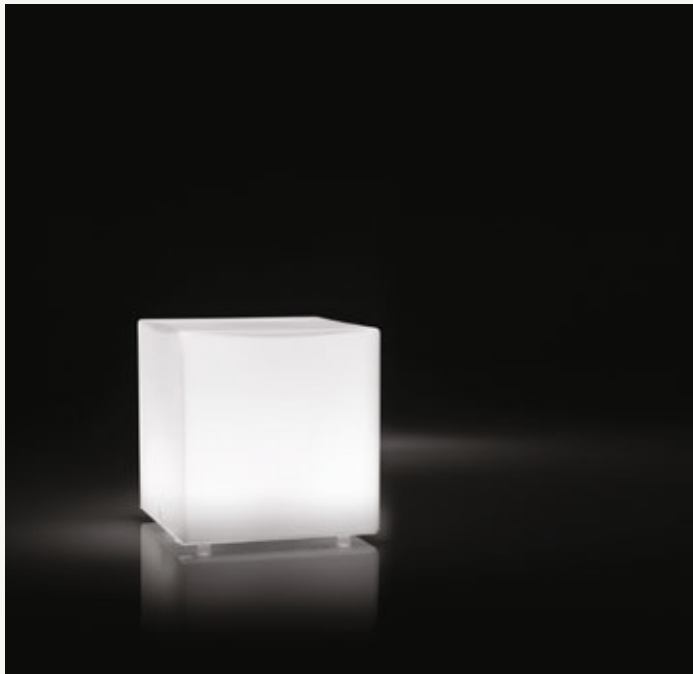

KUBIK

Studio Tecnico Panzeri 2001

LED CE IP40 (IP20 Table) 

	CODICE / CODE	CM A x B	H	INCHES A x B	H	FONTI LUMINOSE / LIGHT SOURCES
Sospensione / Suspension	L07001.011.0101	11 x 11	73 → 128	4 ¼" x 4 ¼"	28 ¾" → 50 ½"	Potenza assorbita apparecchio / Luminaire power consumption 9,5W Flusso luminoso apparecchio / Luminaire luminous flux 667lm 3000K Ra80 220-240V
	L07001.014.0101	14 x 14	76 → 128	5 ½" x 5 ½"	30" → 50 ½"	Potenza assorbita apparecchio / Luminaire power consumption 13W Flusso luminoso apparecchio / Luminaire luminous flux 954lm 3000K Ra80 220-240V
Parete/soffitto / Wall/ceiling <input type="checkbox"/>	A07001.011.0101	11 x 11	11	4 ¼" x 4 ¼"	4 ¼"	Potenza assorbita apparecchio / Luminaire power consumption 9,5W Flusso luminoso apparecchio / Luminaire luminous flux 667lm 3000K Ra80 220-240V
	A07001.011.0000	11 x 11	11	4 ¼" x 4 ¼"	4 ¼"	LED retrofit bulb E14 Lmax. 75mm - Ø max. 45mm max 60W E14
	<input type="checkbox"/> A07001.014.0101	14 x 14	14	5 ½" x 5 ½"	5 ½"	Potenza assorbita apparecchio / Luminaire power consumption 13W Flusso luminoso apparecchio / Luminaire luminous flux 954lm 3000K Ra80 220-240V
	A07001.014.0000	14 x 14	14	5 ½" x 5 ½"	5 ½"	LED retrofit bulb E27 Lmax. 100mm - Ø max. 55mm max 70W E27 max 23W Micro Twist E27
Tavolo / Table	C07001.011.0101	11 x 11	11	4 ¼" x 4 ¼"	4 ¼"	Potenza assorbita apparecchio / Luminaire power consumption 9,5W Flusso luminoso apparecchio / Luminaire luminous flux 667lm 3000K Ra80 220-240V
	C07001.014.0101	14 x 14	14	5 ½" x 5 ½"	5 ½"	Potenza assorbita apparecchio / Luminaire power consumption 13W Flusso luminoso apparecchio / Luminaire luminous flux 954lm 3000K Ra80 220-240V

Fotometrie e Classi Energetiche disponibili www.panzeri.it / Photometric data and Energy Label available at www.panzeri.it

CODICI COLORI DISPONIBILI / COLOUR CODES AVAILABLE

01 Bianco
White



WILLY

Enzo Panzeri 2002/07/09

Diffusore a campana reminiscenza di un linguaggio industriale ripensato in chiave contemporanea. Willy è una famiglia di sospensioni disponibili in vetro soffiato, alluminio e polietilene, un ventaglio di soluzioni che soddisfa ogni esigenza di stile. Quattro i diametri complessivamente disponibili a seconda della tipologia.

Bell-shaped diffuser reminiscent of an industrial language re-thought in a contemporary key. Willy is a family of suspensions which is available in blown glass, aluminum and polyethylene, a range of solutions that satisfy every style requirement. Depending on the type four diameters are available overall.



Ø 60
WILLY GLASS
WILLY ALU



Ø 50
WILLY GLASS



Ø 40
WILLY GLASS



Ø 100
WILLY XL

WILLY XL

Enzo Panzeri 2007

Diffusore a campana, reminiscenza di un linguaggio industriale ripensato in chiave contemporanea, nella declinazione in polietilene Willy è disponibile in diametro 100cm, in nero, bianco, decorato a mano in foglia oro e a richiesta in foglia argento o foglia rame.

Bell-shaped diffuser reminiscent of an industrial language re-thought in a contemporary key, in the polyethylene declination Willy is available in 100cm diameter, black, white, hand-made decorated in golden leaf finishes are available, silver leaf or copper leaf finishes are available on request.





WILLY XL

Enzo Panzeri 2007



Polietilene / Polyethylene	CODICE / CODE	CM Ø H	INCHES Ø H	FONTI LUMINOSE / LIGHT SOURCES
Sospensione / Suspension	L076__100.0102	100 63	39 3/8" 24 1/2"	Potenza assorbita apparecchio / Luminaire power consumption 40W Flusso luminoso apparecchio / Luminaire luminous flux 3859lm 3000K Ra80 220-240V DALI / PUSH DIM
		Cable length 200 / 78 1/2"		
	L076__100.0000	100 63	39 3/8" 24 1/2"	4x LED retrofit bulb E27 Lmax. 140mm - Ø max. 65mm 4x max 30W Superstar E27 4x max 100W E27
		Cable length 200 / 78 1/2"		

Fotometrie e Classi Energetiche disponibili www.panzeri.it / Photometric data and Energy Label available at www.panzeri.it**CODICI COLORI DISPONIBILI / COLOUR CODES AVAILABLE**

2 1 Foglia oro / Foglia oro Gold leaf / Gold leaf	2 3 Foglia argento / Foglia argento (a richiesta) Silver leaf / Silver leaf (available on request)	2 4 Foglia rame / Foglia rame (a richiesta) Copper leaf / Copper leaf (available on request)	3 1 Grigio metallizzato / Nero Metallized grey / Black	3 3 Grigio metallizzato / Bianco Metallized grey / White
---	--	--	--	--



WILLY GLASS

Enzo Panzeri 2002

Diffusore a campana, reminiscenza di un linguaggio industriale ripensato in chiave contemporanea, nella declinazione in vetro soffiato a stampo Willy è disponibile in diametro 40, 50 e 60cm, in nero o bianco satinato.

Bell-shaped reminiscent of an industrial language re-thought in a contemporary key, in the blown glass declination Willy comes in 40, 50 and 60cm diameter, black or mat white finishes are available.







WILLY GLASS

Enzo Panzeri 2002



Vetro / Glass

CODICE / CODE

CM Ø H

INCHES Ø H

FONTI LUMINOSE / LIGHT SOURCES

Sospensione / Suspension

L076__040.0000

40 28

15 3/4" 11"

Cable length 200 / 78 1/2"

LED retrofit bulb E27 Lmax. 120mm - Ø max. 65mm
max 23W Micro Twist E27
max 150W E27**L076__050.0000**

50 30

19 5/8" 11 3/4"

Cable length 200 / 78 1/2"

LED retrofit bulb E27 Lmax. 120mm - Ø max. 65mm
max 30W Superstar E27
max 150W E27**L076__060.0102**

60 37

23 5/8" 14 5/8"

Cable length 200 / 78 1/2"

Potenza assorbita apparecchio / Luminaire power consumption 40W
Flusso luminoso apparecchio / Luminaire luminous flux 3859lm
3000K Ra80 220-240V DALI / PUSH DIM**L076__060.0000**

60 37

23 5/8" 14 5/8"

Cable length 200 / 78 1/2"

3x LED retrofit bulb E27 Lmax. 140mm - Ø max. 65mm
3x max 30W Superstar E27
3x max 100W E27**CODICI COLORI DISPONIBILI / COLOUR CODES AVAILABLE****3 1** Grigio metallizzato / nero
Metallized grey / black**3 3** Grigio metallizzato / bianco
Metallized grey / white

WILLY ALU

Enzo Panzeri 2009

Diffusore a campana, reminiscenza di un linguaggio industriale ripensato in chiave contemporanea, nella declinazione in alluminio Willy è disponibile in diametro 60cm, finiture in bianco lucido, decorato a mano in foglia oro e a richiesta in foglia argento o foglia rame.

Bell-shaped reminiscent of an industrial language re-thought in a contemporary key, in the aluminum declination Willy is available in 60cm diameter, glossy white or hand-made decorated in golden leaf finishes are available, silver leaf or copper leaf finishes are available on request.





WILLY ALU	Enzo Panzeri 2009					LED CE IP20 
Alluminio / Aluminium	CODICE / CODE	CM Ø	H	INCHES Ø	H	FONTI LUMINOSE / LIGHT SOURCES
Sospensione / Suspension	L076_ _060.0000	60	37	23 5/8"	14 5/8"	3x LED retrofit bulb E27 Lmax. 140mm - Ø max. 65mm 3x max 30W Superstar E27 3x max 100W E27
		Cable length 200 / 78 3/4"				

Disponibile anche in versione **LED / LED** version available

Fotometrie e Classi Energetiche disponibili www.panzeri.it / Photometric data and Energy Label available at www.panzeri.it

CODICI COLORI DISPONIBILI / COLOUR CODES AVAILABLE

1 0 Bianco lucido Glossy white	2 1 Foglia oro Gold leaf	2 3 Foglia argento (a richiesta) Silver leaf (available on request)	2 4 Foglia rame (a richiesta) Copper leaf (available on request)
--	------------------------------------	---	--

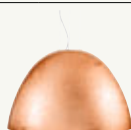
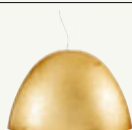

BLANCA

Federico Churba 2012

Blanca è un apparecchio a sospensione in alluminio tornito disponibile in due diametri, entrambi equipaggiati con tecnologia DALI / PUSH DIM integrata nel rosone. La sorgente LED di ultima generazione scompare nell'accoppiamento al corpo lampada con diffusore a incastro in PMMA. L'emissione di luce interna produce una piacevole sensazione di propagazione diffusa, diretta e indiretta, grazie alla caratteristica calotta cava. Disponibile in bianco lucido e marrone metallizzato con dettaglio del cavo di alimentazione in tessuto rosso.

Blanca is a turned aluminum pendant luminaire which comes in two diameters, both equipped with DALI / PUSH DIM technology integrated into the canopy. The latest generation LED source disappears when coupled to the lamp body with a PMMA interlocking diffuser. The emission of internal light produces a pleasant diffusion, direct and indirect, thanks to the characteristic hollow calotte. It is available in glossy white and metallized brown with red fabric power supply cable.







BLANCA60

BLANCA90

BLANCA

Federico Churba 2012

LED **CE** IP40

	CODICE / CODE	CM Ø H	INCHES Ø H	FONTI LUMINOSE / LIGHT SOURCES
Sospensione / Suspension	L057__ .060.0102	60 23	Ø 23 3/8" 9"	Potenza assorbita apparecchio / Luminaire power consumption 70W Flusso luminoso apparecchio / Luminaire luminous flux 4419lm 3000K Ra80 220-240V DALI / PUSH DIM
		Cable length 200 / 78 1/2"		
	L057__ .090.0102	89 28	Ø 35" 11"	Potenza assorbita apparecchio / Luminaire power consumption 66W Flusso luminoso apparecchio / Luminaire luminous flux 4738lm 3000K Ra80 220-240V DALI / PUSH DIM*
		Cable length 200 / 78 1/2"		

Fotometrie e Classi Energetiche disponibili www.panzeri.it / Photometric data and Energy Label available at www.panzeri.it

CODICI COLORI DISPONIBILI / COLOUR CODES AVAILABLE

DISPONIBILI A RICHIESTA LED 2700K / ON REQUEST 2700K LED AVAILABLE

01 Bianco lucido
Glossy white

44 Marrone metallizzato
Metallized brown

* max 4 fixtures PUSH DIM



FLAT

Enzo Panzeri 2014

Lastra in policarbonato opale accoppiata ad una struttura in alluminio. Nelle versioni a sospensione, parete/soffitto e incasso prende la forma di un quadrato e nella versione a parete si trasforma, diventando un rettangolo. Il sottile perimetro luminoso colpisce per la leggerezza che riesce a trasmettere. Flat a incasso è disponibile con emergenza ed è studiata per l'appoggio immediato nei controsoffitti modulari standard. L'emissione di luce si modifica al variare della tipologia di installazione, diretta e indiretta per sospensione e parete, solo diretta per incasso e parete/soffitto. Bianco e a richiesta foglia oro e foglia argento le finiture disponibili.

Opal polycarbonate sheet coupled with an aluminum structure. Square shaped in suspension, wall/ceiling and recessed versions and rectangular in the wall version. The thin luminescent perimeter is striking for the lightness it manages to transmit. Flat recessed is available with emergency and is designed to be easily integrated in standard modular false ceiling panels. The light emission changes according to the mounting version, direct and indirect for suspension and wall lamp, only direct for recessed and wall/ceiling lamp. It is available in white finish. Hand-made decorated in golden leaf and silver leaf are available on request.













FLAT		Enzo Panzeri 2014				LED CE IP40
	CODICE / CODE	CM A x B	H	INCHES A x B	H	FONTI LUMINOSE / LIGHT SOURCES
Sospensione / Suspension	L07501.051.0102	51 x 51	4,5	20" x 20"	1 7/8"	Potenza assorbita apparecchio / Luminaire power consumption 61W Flusso luminoso apparecchio / Luminaire luminous flux 4077lm 3000K Ra80 220-240V DALI / PUSH DIM*
Soffitto-parete / Ceiling-wall	 P07501.038.0101	38 x 38	4,5	15" x 15"	1 7/8"	Potenza assorbita apparecchio / Luminaire power consumption 24W Flusso luminoso apparecchio / Luminaire luminous flux 1147lm 3000K Ra80 220-240V
	 P07501.051.0102	51x51	4,5	20" x 20"	1 7/8"	Potenza assorbita apparecchio / Luminaire power consumption 48W Flusso luminoso apparecchio / Luminaire luminous flux 3202lm 3000K Ra80 220-240V DALI / PUSH DIM
Soffitto-incasso / Ceiling recessed	X07501.060.0101	59,5 x 59,5	6	23 3/8" x 23 3/8"	2 3/8"	Potenza assorbita apparecchio / Luminaire power consumption 48W Flusso luminoso apparecchio / Luminaire luminous flux 3202lm 3000K Ra80 220-240V not dimmable
	 X07501.060.0107	59,5 x 59,5	6	23 3/8" x 23 3/8"	2 3/8"	Modalità di installazione ad incasso in appoggio in controsoffitti modulari Resting recessed installation into modular suspended ceilings Potenza assorbita apparecchio / Luminaire power consumption 48W Flusso luminoso apparecchio / Luminaire luminous flux 3202lm 3000K Ra80 220-240V 1H/12H EMERGENCY
Parete / Wall	A07501.038.0101	38 x 13	2,5	15" x 5 1/8"	1"	Potenza assorbita apparecchio / Luminaire power consumption 19W Flusso luminoso apparecchio / Luminaire luminous flux 1069lm 3000K Ra80 220-240V

Fotometrie e Classi Energetiche disponibili www.panzeri.it / Photometric data and Energy Label available at www.panzeri.it

CODICI COLORI DISPONIBILI / COLOUR CODES AVAILABLE

- 0 1** Bianco / White
- 2 1** Foglia oro (a richiesta) / Gold leaf (available on request)
- 2 3** Foglia argento (a richiesta) / Silver leaf (available on request)

* Max 4 fixtures PUSH DIM



CARMEN CARMENCITA

Carmen Ferrara 2013/14

Carmen è un apparecchio di illuminazione che gioca con il movimento e la capacità di spostare liberamente la luce attraverso la rotazione e l'estensione dei suoi bracci. Disponibile a tre sezioni rotanti nella versione a soffitto, due nella versione parete/soffitto e a un braccio fisso a parete nella veste ridotta di Carmencita. La versione a tre bracci è fornita con dimmerazione 1-10V / PUSH DIM di serie. Bianco e nero le finiture disponibili.

Carmen is a lighting fixture that plays with movement and the ability to position the light at will through the rotation and extension of its arms. It comes with three rotating sections in the ceiling version, two in the wall/ceiling version and with a fixed arm in the smallest Carmencita. The three-arm version is supplied with standard 1-10V / PUSH DIM. Black and white finishes are available.





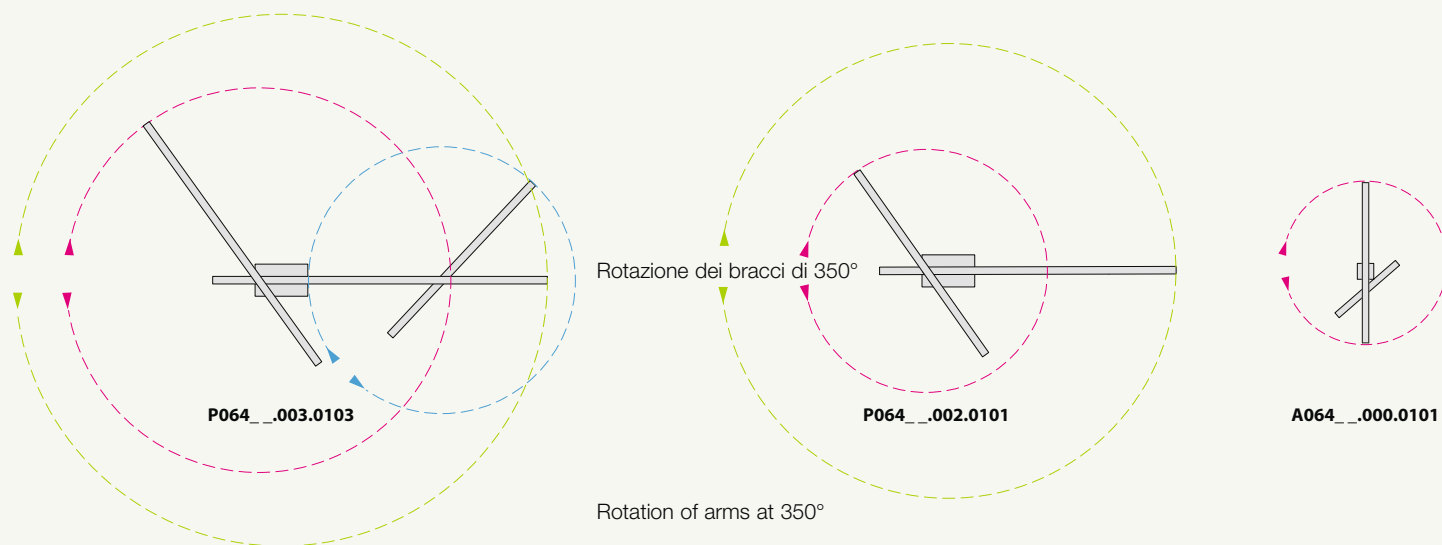

CARMEN CARMENCITA

Carmen Ferrara 2013/14

LED CE IP20 850°

	CODICE / CODE	CM A x B	H	INCHES A x B	H	FONTI LUMINOSE / LIGHT SOURCES
Soffitto / Ceiling	P064__003.0103	222	20	87 1/2"	7 7/8"	Potenza assorbita apparecchio / Luminaire power consumption 56W Flusso luminoso apparecchio / Luminaire luminous flux 5111lm 3000K Ra80 220-240V 1...10V/PUSH DIM
Parete-soffitto / Wall-ceiling	 P064__002.0101	151	20	59 1/2"	7 7/8"	Potenza assorbita apparecchio / Luminaire power consumption 28,5W Flusso luminoso apparecchio / Luminaire luminous flux 2375lm 3000K Ra80 220-240V
Parete / Wall	A064__000.0101	26 x 14	61	10 1/4" x 5 1/2"	24"	Potenza assorbita apparecchio / Luminaire power consumption 13W Flusso luminoso apparecchio / Luminaire luminous flux 967lm 3000K Ra80 220-240V

Fotometrie e Classi Energetiche disponibili www.panzeri.it / Photometric data and Energy Label available at www.panzeri.it

CODICI COLORI DISPONIBILI / COLOUR CODES AVAILABLE

01 Bianco
White

02 Nero
Black



CANDLE

Silvia Poma 2006

Vetro borosilicato che abbina trasparenza e satinato in un elegante contrapposizione. Candle è particolarmente adatta a composizioni multiple in cui il posizionamento a diverse altezze crea ritmi e ondulazioni emozionanti. Rosone standard disponibile fino a un massimo di sei sospensioni, customizzabile a richiesta. Disponibile in versione LED o G9.

Borosilicate glass that combines transparency and satin in an elegant contrast. Candle is particularly suitable for multiple compositions where positioning at different heights creates exciting rhythms and undulations. Standard canopy is available up to a maximum of six suspensions, customizable on request. LED or G9 version are available.











Assolombarda, Confindustria Monza e Brianza (IT) Courtesy of Arch. F. Pella, Sering s.r.l.

ROSONI E DECENTRAMENTI A PAGINA 352 / OFFSET AND CANOPIES PAGE 352

CANDLE		Silvia Poma 2006				LED CE IP20     Suspension no canopy 24V
CODICE / CODE		CM Ø / A x B	H	INCHES Ø / A x B	H	FONTI LUMINOSE / LIGHT SOURCES
Sospensione / suspension	L09501.000.0101	3	55	1 1/2"	22"	Potenza assorbita apparecchio / Luminaire power consumption 4W Flusso luminoso apparecchio / Luminaire luminous flux 266lm 3000K Ra80 220-240V
		Cable length 300 / 118 1/2"				
	L09501.000.0000	3	55	1 1/2"	22"	LED retrofit bulb G9 Lmax. 60mm - Ø max. 17,5mm max 48W G9
		Cable length 300 / 118 1/2"				
Sospensione no rosone / no driver Suspension no canopy / no driver	M09501.000.0110	3	55	1 1/2"	22"	Potenza assorbita apparecchio / Luminaire power consumption 2,8W Flusso luminoso apparecchio / Luminaire luminous flux 266lm 3000K Ra80 24V DC
		Cable length 300 / 118 1/2"				
Sospensione no rosone Suspension no canopy	M09501.000.0000	3	55	1 1/2"	22"	LED retrofit bulb G9 Lmax. 60mm - Ø max. 17,5mm max 48W G9
		Cable length 300 / 118 1/2"				

Fotometrie e Classi Energetiche disponibili www.panzeri.it / Photometric data and Energy Label available at www.panzeri.it

CODICI COLORI DISPONIBILI / COLOUR CODES AVAILABLE

01 Bianco
White

JAZZ

Silvia Poma 2004

Doppio vetro borosilicato che abbina trasparenza e satinato in una elegante contrapposizione.

Jazz è particolarmente adatta a composizioni in cui il posizionamento a diverse altezze crea ritmi e ondulazioni emozionanti. Rosone standard disponibile fino a un massimo di sei sospensioni, customizzabile a richiesta.

Disponibile in versione LED o G9.

Double borosilicate glass that combines transparency and satin finish in an elegant contrast.

Jazz is particularly suitable for configurations in which the positioning at different heights creates exciting rhythms and ripples. Standard canopy is available up to a maximum of six suspensions, customizable on request.

It is available in LED or G9 version.







ROSONI E DECENTRAMENTI A PAGINA 352 / OFFSET AND CANOPIES PAGE 352

JAZZ		Silvia Poma 2004		LED CE IP20 (E) (E) Suspension no canopy 24V)		FONTI LUMINOSE / LIGHT SOURCES
CODICE / CODE		CM Ø / A x B H	INCHES Ø / A x B H			
Sospensione / suspension	L08901.000.0101	6,5 35 2 ½"	13 ¾"	Potenza assorbita apparecchio / Luminaire power consumption 4W Flusso luminoso apparecchio / Luminaire luminous flux 251lm 3000K Ra80 220-240V		
	L08901.000.0000	6,5 35 2 ½"	13 ¾"	LED retrofit bulb G9 Lmax. 60mm - Ø max. 17,5mm max 48W G9		
Sosp. no rosone, no driver Susp. no canopy/no driver	M08901.000.0110	6,5 35 2 ½"	13 ¾"	Potenza assorbita apparecchio / Luminaire power consumption 2,8W Flusso luminoso apparecchio / Luminaire luminous flux 251lm 3000K Ra80 24V DC		
Sospensione no rosone Suspension no canopy	M08901.000.0000	6,5 35 2 ½"	13 ¾"	LED retrofit bulb G9 Lmax. 60mm - Ø max. 17,5mm max 48W G9		
		Cable length 300 / 118 ½"				

Fotometrie e Classi Energetiche disponibili www.panzeri.it / Photometric data and Energy Label available at www.panzeri.it

CODICI COLORI DISPONIBILI / COLOUR CODES AVAILABLE

01 Bianco
White



GILBERT

Studio Tecnico Panzeri 2013

L'artigianalità della soffiatura del globo in vetro opale satinato rende unica ogni Gilbert. Sospensioni singole ed installazioni multiple diffondono una luce morbida, ricreando emozionanti atmosfere oniriche. Disponibile nelle versioni sospensione, tavolo e soffitto in tre dimensioni e con tipologia di sorgente variabile tra LED, E27, G9.

The craftsmanship of the blown globe in satin opal glass makes every Gilbert unique. Single suspensions and multiple installations spread soft light, recreating exciting dreamlike atmospheres. It is available in suspension, table and ceiling versions and comes in three different sizes with LED, E27 or G9 lighting source.









GILBERT

Studio Tecnico Panzeri 2013

LED CE IP20 (IP40 Table)

	CODICE / CODE	CM Ø	H	INCHES Ø	H	FONTE LUMINOSE / LIGHT SOURCES
Sospensione / Suspension	L06501.022.0101	22	14	8 3/8"	5 1/2"	Potenza assorbita apparecchio / Luminaire power consumption 11W Flusso luminoso apparecchio / Luminaire luminous flux 996lm 3000K Ra80 220-240V
	L06501.022.0000	22	14	8 3/8"	5 1/2"	LED retrofit bulb G9 Lmax. 60mm - Ø max. 17,5mm max 60W G9
	L06501.037.0102	37	27	14 4/8"	10 3/8"	Potenza assorbita apparecchio / Luminaire power consumption 27W Flusso luminoso apparecchio / Luminaire luminous flux 2762lm 3000K Ra80 220-240V DALI / PUSH DIM
	L06501.037.0000	37	27	14 4/8"	10 3/8"	LED retrofit bulb E27 Lmax. 140mm - Ø max. 65mm max 18W Micro Twist E27 max 150W E27
	L06501.045.0102	45	33	17 3/4"	13"	Potenza assorbita apparecchio / Luminaire power consumption 27W Flusso luminoso apparecchio / Luminaire luminous flux 2762lm 3000K Ra80 220-240V DALI / PUSH DIM
	L06501.045.0000	45	33	17 3/4"	13"	LED retrofit bulb E27 Lmax. 140mm - Ø max. 65mm max 23W Micro Twist E27 max 150W E27
Soffitto / Ceiling	P06501.037.0102	37	27	14 4/8"	10 3/8"	Potenza assorbita apparecchio / Luminaire power consumption 20W Flusso luminoso apparecchio / Luminaire luminous flux 2029lm 3000K Ra80 220-240V DALI / PUSH DIM
	P06501.037.0000	37	27	14 4/8"	10 3/8"	LED retrofit bulb E27 Lmax. 100mm - Ø max. 55mm max 18W Micro Twist E27 max 150W E27
	P06501.045.0102	45	33	17 3/4"	13"	Potenza assorbita apparecchio / Luminaire power consumption 20W Flusso luminoso apparecchio / Luminaire luminous flux 2029lm 3000K Ra80 220-240V DALI / PUSH DIM
	P06501.045.0000	45	33	17 3/4"	13"	LED retrofit bulb E27 Lmax. 100mm - Ø max. 55mm max 23W Micro Twist E27 max 150W E27
Tavolo / Table	C06501.022.0101	22	14	8 3/8"	5 1/2"	Potenza assorbita apparecchio / Luminaire power consumption 11W Flusso luminoso apparecchio / Luminaire luminous flux 996lm 3000K Ra80 220-240V

Fotometrie e Classi Energetiche disponibili www.panzeri.it / Photometric data and Energy Label available at www.panzeri.it**CODICI COLORI DISPONIBILI / COLOUR CODES AVAILABLE****01** Bianco
White

DOMINO

Yohji Terazeri 2005

Un cubo aperto disponibile in due dimensioni, nelle versioni parete/soffitto e sospensione. Domino è un gioco prospettico di pieni e vuoti in cui si alterna la vista del caratteristico cilindro in vetro borosilicato acidato. Gioco ancor più enfatizzato dall'esercizio compositivo messo in atto nelle versioni a vetri multipli, per le quali sono disponibili abbinamenti cromatici bianco/bianco e bianco/nero.



An open box that comes in two sizes, in wall/ceiling and suspension versions. Domino is a perspective game of solids and voids in which the view of the typical frosted borosilicate glass diffuser alternates. The game is even more emphasized in the version with multiple glasses, for which white/white and white/black color combinations are available.









DOMINO		Yohji Terazeri 2005				CE IP40 
	CODICE / CODE	CM A x B	H	INCHES A x B	H	FONTI LUMINOSE / LIGHT SOURCES
Sospensione / Suspension	L090__011.0000	11 x 8	26	4 ¼" x 3 ⅛"	10 ¼"	LED retrofit bulb G9 Lmax. 60mm - Ø max. 17,5mm max 60W G9
	L090__014.0000	14 x 9	29	5 ½" x 3 ½"	11 ½"	LED retrofit bulb G9 Lmax. 60mm - Ø max. 17,5mm max 60W G9
Parete-soffitto / Wall-ceiling	 P090__011.0000	11 x 8	13	4 ¼" x 3 ⅛"	5 ⅞"	LED retrofit bulb G9 Lmax. 60mm - Ø max. 17,5mm max 60W G9
	P090__014.0000	14 x 9	16	5 ½" x 3 ½"	6 ¼"	LED retrofit bulb G9 Lmax. 60mm - Ø max. 17,5mm max 60W G9

Fotometrie e Classi Energetiche disponibili www.panzeri.it / Photometric data and Energy Label available at www.panzeri.it

CODICI COLORI DISPONIBILI / COLOUR CODES AVAILABLE

- 3 1** Grigio metallizzato / Diffusori nero
Metallized grey / Black diffusers
- 3 3** Grigio metallizzato / Diffusori bianchi
Metallized grey / White diffusers



DOMINO		Yohji Terazeri 2005				CE IP40 
	CODICE / CODE	CM A x B	H	INCHES A x B	H	FONTI LUMINOSE / LIGHT SOURCES
Parete-soffitto / Wall-ceiling	P090__004.0000	24 x 28	16	9 ½" x 11"	6 ¼"	4x LED retrofit bulb G9 Lmax. 60mm - Ø max. 17,5mm 4x max 60W G9
	P090__009.0000	43 x 45	19	17" x 17 ¾"	7 ½"	9x LED retrofit bulb G9 Lmax. 60mm - Ø max. 17,5mm 9x max 33W G9

Fotometrie e Classi Energetiche disponibili www.panzeri.it / Photometric data and Energy Label available at www.panzeri.it

CODICI COLORI DISPONIBILI / COLOUR CODES AVAILABLE

- 3 8** Grigio metallizzato / Diffusori bianco-nero
Metallized grey / White-black diffusers



LINE

Studio Tecnico Panzeri 2010





Apparecchio di illuminazione da terra e sospensione, Line non è una linea retta ma il prodotto di un tratto sinuoso e accattivante nel suo sviluppo conico. Bianco, nero, decorato a mano in foglia oro, ottone satinato e titanio le finiture disponibili, a richiesta in foglia argento.

Floor and suspension lighting fixture, Line is not a straight line but the result of a sinuous and captivating conical development. White, black, hand-made decorated in golden leaf mat brass and titanium finishes are available, silver leaf is available on request.





LINE		Studio Tecnico Panzeri 2010				LED CE IP20 (□ Floor)
	CODICE / CODE	CM Ø	H	INCHES Ø	H	FONTI LUMINOSE / LIGHT SOURCES
Sospensione / Suspension	L036__000.0100	8	68	3 1/8"	26 3/4"	Incl. LED bulb 9W GU10 3000K Ra80 840lm 110-240V Not dimmable
Terra / Floor	T036__000.0101	28	185	11"	72 3/4"	Potenza assorbita apparecchio / Luminaire power consumption 10W Flusso luminoso apparecchio / Luminaire luminous flux 990lm 3000K Ra80 220-240V

Fotometrie e Classi Energetiche disponibili www.panzeri.it / Photometric data and Energy Label available at www.panzeri.it

CODICI COLORI DISPONIBILI / COLOUR CODES AVAILABLE

01 Bianco White	02 Nero Black	19 Ottone satinato Mat brass	21 Foglia oro Gold leaf	23 Foglia argento (a richiesta) Silver leaf (available on request)	30 Titanio Titanium
---------------------------	-------------------------	--	-----------------------------------	--	-------------------------------



NOVELTY

NOVELTY

ZERO

Studio Tecnico Panzeri 2012

Linearità e sezione cava definiscono Zero, apparecchio di illuminazione da parete/soffitto ad emissione di luce indiretta. Zero appare come un tratto disegnato a parete, il cui posizionamento e orientamento è una libera scelta progettuale, conseguenza della ricerca di parallelismi ed allineamenti all'interno degli ambienti. Corpo lampada in ottone. Bianco, decorato a mano in foglia oro, cromo, bronzo e ottone satinato le finiture disponibili, a richiesta in foglia argento e foglia rame.

Linearity and hollow section define Zero, a wall/ceiling lighting fixture with indirect light emission. Zero appears as a line drawn on a wall, whose positioning and orientation is a free choice of design, a consequence of the search for parallelisms and alignments within the rooms. Lamp body in brass. White, hand made decorated in golden leaf, chrome, bronze and mat brass finishes are available, silver leaf and copper leaf are available on request.









ZERO

Studio Tecnico Panzeri 2012

Registered Design



	CODICE / CODE	CM A x B H	INCHES A x B H	FONTI LUMINOSE / LIGHT SOURCES
Parete / Wall	<input type="checkbox"/> A035_..050.0101	52 x 7,5 3	L 20 ½" x 3" 1 ½"	Potenza assorbita apparecchio / Luminaire power consumption 11W Flusso luminoso apparecchio / Luminaire luminous flux 700lm 3000K Ra80 220-240V
	<input type="checkbox"/> A035_..100.0101	102 x 7,5 3	L 40 ½" x 3" 1 ½"	Potenza assorbita apparecchio / Luminaire power consumption 20W Flusso luminoso apparecchio / Luminaire luminous flux 1400lm 3000K Ra80 220-240V

Fotometrie e Classi Energetiche disponibili www.panzeri.it / Photometric data and Energy Label available at www.panzeri.it**CODICI COLORI DISPONIBILI / COLOUR CODES AVAILABLE****DISPONIBILI A RICHIESTA LED 2700K / ON REQUEST 2700K LED AVAILABLE**

01 Bianco White	17 Bronzo Bronze	19 Ottone satinato Mat brass	21 Foglia oro Gold leaf	22 Cromo Chrome	23 Foglia argento (a richiesta) Silver leaf (available on request)	24 Foglia rame (a richiesta) Copper leaf (available on request)
---------------------------	----------------------------	--	-----------------------------------	---------------------------	--	---

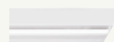

NOVELTY

NOVELTY

YPSILON

Studio Tecnico Panzeri 2013

Il nome deriva dalla forma che questo apparecchio disegna con la parete, evidenza di una complementarità quasi spontanea, più o meno marcata, a seconda della scelta di una montatura in esterno o a incasso. La graduale distanza della sorgente dalla parete determina una particolare diffusione a "fiamma". Corpo lampada in ottone. Bianco, nero, bronzo, ottone satinato e cromo le finiture disponibili.

The name comes from the shape that this lamp draws with the wall, evidence of a spontaneous complementarity, more or less marked, depending on the choice of external rather than recessed frame. The gradual spacing of the source from the wall shows a particular "flame" diffusion on the wall. Lamp body in brass. White, black, bronze, mat brass and chrome finishes are available.







YPSILON

Studio Tecnico Panzeri 2013

LED CE IP20

	CODICE / CODE	CM A x B	H	INCHES B	H	FONTI LUMINOSE / LIGHT SOURCES
Parete / Wall	A072_000.0101	3 x 14,5	62	1 1/8" x 5 7/8"	24 3/8"	Potenza assorbita apparecchio / Luminaire power consumption 13W Flusso luminoso apparecchio / Luminaire luminous flux 1118 3000K Ra80 220-240V
	X072_000.0101	3 x 11	62	1 1/8" x 4 1/8"	24 3/8"	Potenza assorbita apparecchio / Luminaire power consumption 13W Flusso luminoso apparecchio / Luminaire luminous flux 1118lm 3000K Ra80 220-240V

Fotometrie e Classi Energetiche disponibili www.panzeri.it / Photometric data and Energy Label available at www.panzeri.it

CODICI COLORI DISPONIBILI / COLOUR CODES AVAILABLE

01 Bianco
White

02 Nero
Black

17 Bronzo
Bronze

19 Ottone satinato
Mat brass

22 Cromo
Chrome



NOVELTY

NOVELTY

CROSS

Andrea Lazzari 2012

Cross è un intreccio, una trama di luce che passa attraverso le fasce che avvolgono il diffusore in vetro acidato. Ad emissione diretta e indiretta, in due diversi formati. Bianco, decorato a mano in foglia oro e ottone satinato le finiture disponibili.

Cross is a weave, a texture of light that passes through the bands that surround the frozed glass diffuser. With direct and indirect emission, in two different sizes. White, hand-made decorated in golden leaf and mat brass finishes are available.





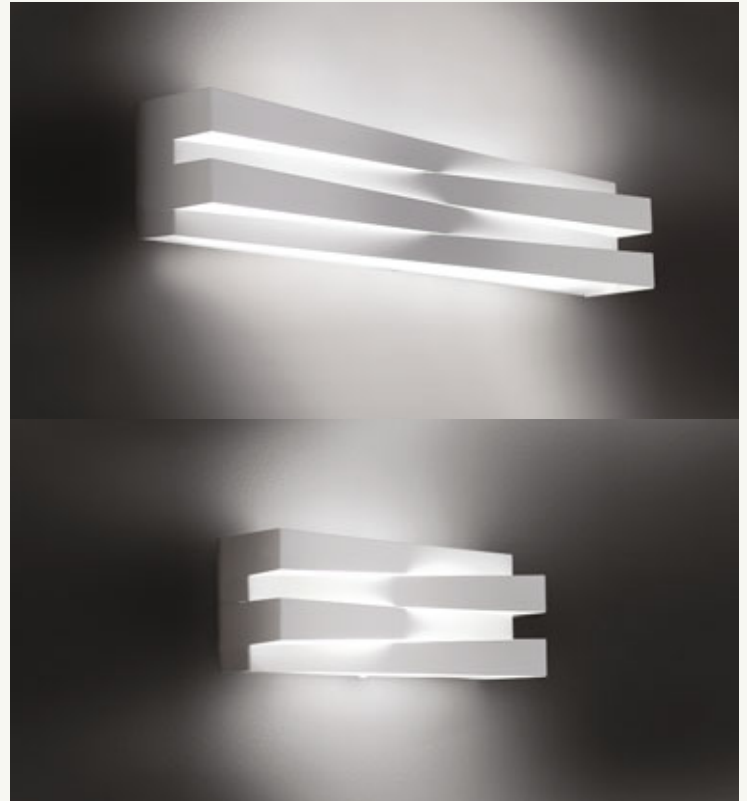

CROSS

Andrea Lazzari 2012

LED CE IP20

	CODICE / CODE	CM A x B	H	INCHES A x B	H	FONTE LUMINOSE / LIGHT SOURCES
Parete / Wall	A049__030.0101	30 x 9	11,5	11 3/4" x 3 1/2"	4 1/2"	Potenza assorbita apparecchio / Luminaire power consumption 20W Flusso luminoso apparecchio / Luminaire luminous flux 2340lm 3000K Ra80 220-240V
	A049__030.0102	30 x 9	11,5	11 3/4" x 3 1/2"	4 1/2"	Potenza assorbita apparecchio / Luminaire power consumption 20W Flusso luminoso apparecchio / Luminaire luminous flux 2340lm 3000K Ra80 220-240V DALI / PUSH DIM
	A049__060.0101	60 x 9	11,5	23 5/8" x 3 1/2"	4 1/2"	Potenza assorbita apparecchio / Luminaire power consumption 40W Flusso luminoso apparecchio / Luminaire luminous flux 4680lm 3000K Ra80 220-240V
	A049__060.0102	60 x 9	11,5	23 5/8" x 3 1/2"	4 1/2"	Potenza assorbita apparecchio / Luminaire power consumption 40W Flusso luminoso apparecchio / Luminaire luminous flux 4680lm 3000K Ra80 220-240V DALI / PUSH DIM

Fotometrie e Classi Energetiche disponibili www.panzeri.it / Photometric data and Energy Label available at www.panzeri.it

CODICI COLORI DISPONIBILI / COLOUR CODES AVAILABLE

DISPONIBILI A RICHIESTA LED 2700K / ON REQUEST 2700K LED AVAILABLE

01 Bianco
White

19 Ottone satinato
Mat brass

21 Foglia oro
Gold leaf



NOVELTY

AGAVE

Diego Chilò 2009

Una nebulosa di petali che gravitano attorno alla luce. Agave è una famiglia di apparecchi a sospensione e plafone che caratterizza fortemente gli ambienti in cui si inserisce, sintesi di una forma organica ripensata per dare luce. Bianco e a richiesta foglia oro, foglia argento e foglia rame le finiture disponibili.

A nebula of petals gravitating around the light. Agave is a family of suspension and ceiling lighting fixtures that strongly characterize the environments in which it is placed, a synthesis of an organic shape redesigned to give light. White finish is available, hand-made decorated in golden, silver and copper leaf finishes are available on request.











AGAVE

Diego Chilò 2009

CE IP20 

CODICE / CODE

CM Ø

H

INCHES Ø

H

FONTI LUMINOSE / LIGHT SOURCES

Sospensione / Suspension

L03001.050.0000

51

77

20"

30 ¼"

LED retrofit bulb E27 Lmax. 140mm - Ø max. 65mm
max 30W Superstar E27
max 205W E27
+ LED retrofit spot GU10 MR 16 Lmax. 60mm - Ø max. 60mm

L03001.070.0000

71

84

28"

33"

4x LED retrofit bulb E27 Lmax. 140mm - Ø max. 65mm
4x max 30W Superstar E27
4x max 150W E27
+ LED retrofit spot GU10 MR 16 Lmax. 60mm - Ø max. 60mm

L03001.090.0000

89

117

35"

46"

6x LED retrofit bulb E27 Lmax. 140mm - Ø max. 65mm
6x max 30W Superstar E27
6x max 150W E27 GU10
+ LED retrofit spot GU10 MR 16 Lmax. 60mm - Ø max. 60mm

Soffitto / Ceiling

P03001.050.0000

51

32

20"

12 ½"

LED retrofit bulb E27 Lmax. 115mm - Ø max. 65mm
max 23W Micro Twist E27
max 205W E27
+ LED retrofit spot GU10 MR 16 Lmax. 60mm - Ø max. 60mm

Fotometrie e Classi Energetiche disponibili www.panzeri.it / Photometric data and Energy Label available at www.panzeri.it

CODICI COLORI DISPONIBILI / COLOUR CODES AVAILABLE

0 1 Bianco
White

2 1 Foglia oro (a richiesta)
Gold leaf (available on request)

2 3 Foglia argento (a richiesta)
Silver leaf (available on request)

2 4 Foglia rame (a richiesta)
Copper leaf (available on request)

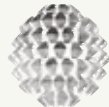
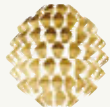

FLORAL

Hiroki Takada 2007

Da antiche logiche ereditate dall'arte dell'origami nasce Floral, un fiore da tavolo e sospensione che interagisce in un gioco di riflessioni con l'ambiente circostante. Floral è disponibile in due formati, finitura cromo.

Floral comes from ancient logics inherited from the art of origami, a table flower and suspension that interacts in a game of reflections with the surrounding environment. Floral is available in two sizes, with chrome finishing.









FLORAL

Hiroki Takada 2007

CE IP20 (□ Table) 

	CODICE / CODE	CM Ø	INCHES Ø	FONTI LUMINOSE / LIGHT SOURCES
Sospensione / Suspension	L01322.040.0000	40	15 3/4"	LED retrofit bulb E27 Lmax. 160mm - Ø max. 42mm max 18W Superstar E27 max 150W E27
	L01322.060.0000	60	23 5/8"	LED retrofit bulb E27 Lmax. 140mm - Ø max. 65mm max 30W Superstar E27 max 150W E27
Tavolo / Table	C01322.040.0000	40	15 3/4"	LED retrofit bulb E27 Lmax. 160mm - Ø max. 42mm max 18W Superstar E27 max 150W E27
	C01322.060.0000	60	23 5/8"	LED retrofit bulb E27 Lmax. 140mm - Ø max. 65mm max 150W E27

Fotometrie e Classi Energetiche disponibili www.panzeri.it / Photometric data and Energy Label available at www.panzeri.it**CODICI COLORI DISPONIBILI / COLOUR CODES AVAILABLE****22** Cromo
Chrome

TWISTER

Enzo Panzeri 1998

Twister è un apparecchio sinuoso disponibile nelle versioni terra, tavolo, sospensione e parete. La torsione compiuta dal vetro soffiato gli conferisce un carattere dinamico, evocando un perpetuo moto rotazionale. Struttura finitura titanio e vetro bianco satinato.

Twister is a sinuous lighting fixture which is available in floor, table, suspension and wall versions. The twist made by the blown glass gives it a dynamic feature, evoking a perpetual rotational motion. Titanium finish structure and satin white glass are available.







TWISTER

Enzo Panzeri 1998

CE IP20 (☐ Table / Floor) ⚙️

	CODICE / CODE	CM Ø / A x B	H	INCHES Ø / A x B	H	FONTI LUMINOSE / LIGHT SOURCES
Sospensione / Suspension	L06730.050.0000	20	55	8"	21 ½"	LED retrofit bulb E27 Lmax. 115mm - Ø max. 60mm max 23W Micro Twist E27 max 150W E27
Parete / Wall	A06730.035.0000	24 x 11	32	9 ½" x 4 ¼"	12 ½"	LED retrofit bulb E27 Lmax. 110mm - Ø max. 60mm max 23W Micro Twist E27 max 70W E27
	A06730.050.0000	24 x 11	51	9 ½" x 4 ¼"	20"	2x LED retrofit bulb E27 Lmax. 110mm - Ø max. 60mm 2x max 23W Micro Twist E27 2x max 70W E27
Tavolo / Table	C06730.035.0000	15	51	6"	20"	LED retrofit bulb E14 Lmax. 75mm - Ø max. 45mm max 60W E14
	C06730.050.0000	21	78	8 ¼"	30 ¾"	LED retrofit bulb E27 Lmax. 115mm - Ø max. 60mm max 23W Micro Twist E27 max 150W E27
Terra / Floor	T06730.000.0000	29	183	11 ½"	72"	LED retrofit bulb E27 Lmax. 115mm - Ø max. 60mm max 205W E27

Fotometrie e Classi Energetiche disponibili www.panzeri.it / Photometric data and Energy Label available at www.panzeri.it

CODICI COLORI DISPONIBILI / COLOUR CODES AVAILABLE

30 Titanio
Titanium



VIKI

Studio Tecnico Panzeri 2011



VIKI è un apparecchio a parete e sospensione disponibile in due dimensioni. Diffonde luce attraverso un tessuto bielastico trattato con "Retard" teso su una struttura dall'originale geometria scomposta in poligoni, a risaltarne la tridimensionalità e definirne il carattere espressivo. Disponibile in bianco.

VIKI is a wall and suspension lighting fixture which comes in two sizes. It diffuses light through a bielastic fabric treated with "Retard" and stretched on a geometric structure decomposed into polygons, to highlight its three-dimensionality and define its expressiveness. White finish is available.

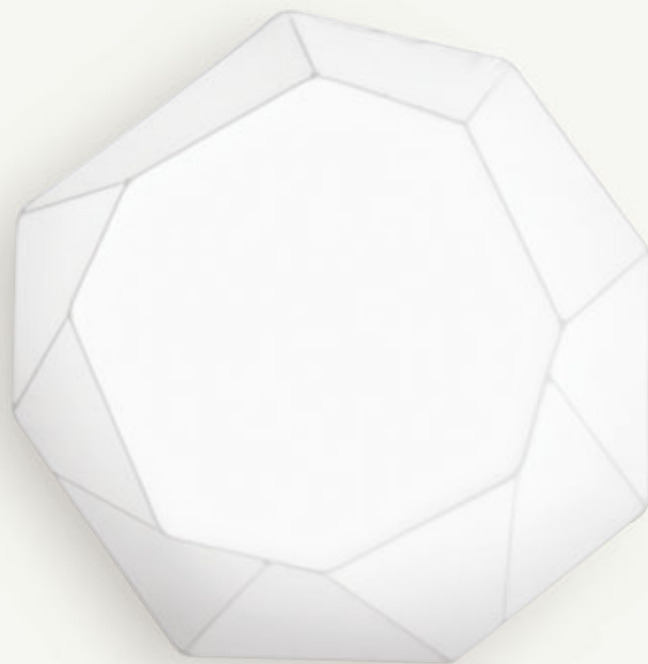

VIKI	Studio Tecnico Panzeri 2011	Registered Design		CE IP20 	
	CODICE / CODE	CM Ø H	INCHES Ø H	FONTI LUMINOSE / LIGHT SOURCES	
Sospensione / Suspension	L04101.055.0000	55 18	21 ½" 7"	2x LED retrofit bulb E27 Lmax. 140mm - Ø max. 65mm 2x max 30W Superstar E27 2x max 53W E27	
	L04101.075.0000	75 22	29 ½" 8 ½"	3x LED retrofit bulb E27 Lmax. 140mm - Ø max. 65mm 3x max 30W Superstar E27 3x max 53W E27	
Soffitto-parete/ Ceiling-wall <input type="checkbox"/>	P04101.055.0000	55 18	21 ½" 7"	2x LED retrofit bulb E27 Lmax. 140mm - Ø max. 65mm 2x max 30W Superstar E27 2x max 53W E27	
	P04101.075.0000	75 22	29 ½" 8 ½"	3x LED retrofit bulb E27 Lmax. 140mm - Ø max. 65mm 3x max 30W Superstar E27 3x max 53W E27	

Fotometrie e Classi Energetiche disponibili www.panzeri.it / Photometric data and Energy Label available at www.panzeri.it

CODICI COLORI DISPONIBILI / COLOUR CODES AVAILABLE

01 Bianco
White



ELLE
Highlight 2012



Elle è un apparecchio dal design minimale a luce orientabile, disponibile con sorgente luminosa singola o doppia. A scelta la sorgente può essere nascosta o a vista, disponibile in metallo bianco.

Elle is a minimalist adjustable lighting fixture, that comes with single or double lighting source that can be positioned at will. White metal available.



P05001.001.0011



P05101.001.0011



P05001.002.0011





P05101.002.0011



P05101.001.0011

ELLE

Highlight 2012

CE IP20  

	CODICE / CODE	CM A x B	H	INCHES A x B	H	FONTI LUMINOSE / LIGHT SOURCES
Parete-soffitto / Wall-ceiling <input type="checkbox"/>	P05001.001.0011	16,5 x 16,5	16,5	6 1/2" x 6 1/2"	6 1/2"	max 75W G53 12V QR111
	P05001.002.0011	33 x 16,5	16,5	13" x 6 1/2"	6 1/2"	2x max 75W G53 12V QR111
	P05101.001.0011	16,5 x 16,5	16,5	6 1/2" x 6 1/2"	6 1/2"	max 75W G53 12V QR111
	P05101.002.0011	33 x 16,5	16,5	13" x 6 1/2"	6 1/2"	2x max 75W G53 12V QR111

+ ELECTRIC OPTIONS:

XM5/111AC 22,5W 3000K 40° Ra83 220-240V 1850lm NOT DIMMABLE



Fotometrie e Classi Energetiche disponibili www.panzeri.it / Photometric data and Energy Label available at www.panzeri.it

CODICI COLORI DISPONIBILI / COLOUR CODES AVAILABLE

01 Bianco
White



DISCO

Studio Tecnico Panzeri 2006



Un disco di luce diffusa, da parete e soffitto, in vetro soffiato satinato bianco disponibile in tre dimensioni. Struttura a scomparsa nelle versioni piccola e media. Disponibile anche in versione LED.

Diffused light comes out this disk, wall and ceiling lighting fixture in mat blown white glass that comes in three sizes. In the small and medium versions the structure is concealed. LED version available.

DISCO

Studio Tecnico Panzeri 2006



	CODICE / CODE	CM Ø	H	INCHES Ø	H	FONTI LUMINOSE / LIGHT SOURCES
Soffitto / Ceiling	<input type="checkbox"/> P06601.030.0101	30	9	11 3/4"	3 1/2"	Potenza assorbita apparecchio / Luminaire power consumption 13W Flusso luminoso LED / LED luminous flux 1460lm 3000K Ra80 220-240V
	P06601.030.0000	30	9	11 3/4"	3 1/2"	LED retrofit bulb E27 Lmax. 100mm - Ø max. 55mm max 14W Micro Twist E27 max 53W E27
	P06601.040.0101	40	10	15 3/4"	4"	Potenza assorbita apparecchio / Luminaire power consumption 19W Flusso luminoso LED / LED luminous flux 2190lm 3000K Ra80 220-240V
	P06601.040.0000	40	10	15 3/4"	4"	2x LED retrofit bulb E27 Lmax. 100mm - Ø max. 55mm 2x max 18W Micro Twist E27 2x max 53W E27
	P06601.050.0101	50	16	19 3/4"	6 1/4"	Potenza assorbita apparecchio / Luminaire power consumption 19W Flusso luminoso LED / LED luminous flux 2190lm 3000K Ra80 220-240V
	P06601.050.0000	50	16	19 3/4"	6 1/4"	2x LED retrofit bulb E27 Lmax. 100mm - Ø max. 55mm 2x max 23W Micro Twist E27 2x max 53W E27

Fotometrie e Classi Energetiche disponibili www.panzeri.it / Photometric data and Energy Label available at www.panzeri.it

CODICI COLORI DISPONIBILI / COLOUR CODES AVAILABLE

DISPONIBILI A RICHIESTA LED 2700K / ON REQUEST 2700K LED AVAILABLE

01 Bianco
White



CLASSIC

Studio Tecnico Panzeri 1979

Classic riprende il tradizionale paralume in tessuto, declinato per le versioni terra, tavolo e parete.

Alla versione a struttura fissa si aggiungono varianti a uno o due bracci estensibili, una reinterpretazione del classico arricchita di nuove possibilità. Paralume a norma di reazione al fuoco (CLASSE 1) UNI 8456/87.

Classic is the revival of the traditional fabric lampshade, which is available in floor, table and wall versions. With the fixed structure or with one or two extendable arms, this lamp is a reinterpretation of the classic enriched with new possibilities. Lampshade reaction to fire (CLASS 1) UNI 8456/87.







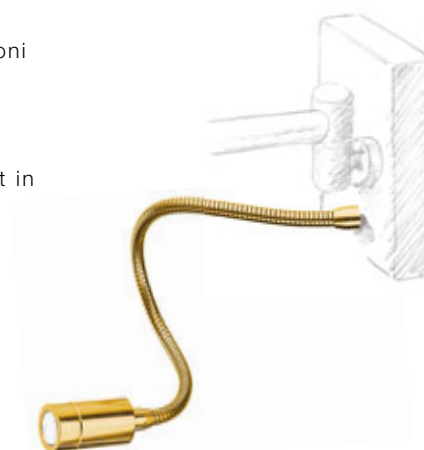

Per progetti, disponibili su richiesta versioni a parete con flessibile a LED, ottone o cromo, completo di driver e interruttore.

Wall-mounted version available on request in brass or chrome, includes flexible LED, complete with driver and switch.





CLASSIC Studio Tecnico Panzeri 1979						CE IP20 ( Table / Floor) 
	CODICE / CODE	CM Ø	H	INCHES Ø	H	FONTI LUMINOSE / LIGHT SOURCES
Parete / Wall	A024___.001.0000	27 → 32	26	10 ½" → 12 ½"	10 ¼"	LED retrofit bulb E27 Lmax. 120mm - Ø max. 65mm max 18W Micro Twist E27 max 53W E27
	A024___.002.0000	30 → 49	29	11 ¾" → 19 ¼"	11 ½"	LED retrofit bulb E27 Lmax. 120mm - Ø max. 65mm max 18W Micro Twist E27 max 53W E27
	M24-1	Schermo in vetro per A024___.001.0000 Glass screen for A024___.002.0000		22	8 ½"	
Tavolo / Table	C024___.001.0000	27	39	10 ½"	15 ¼"	LED retrofit bulb E27 Lmax. 120mm - Ø max. 65mm max 18W Micro Twist E27 max 53W E27
	M24-1	Schermo in vetro per C024___.001.0000 Glass screen for		22	8 ½"	
	C024___.002.0000	30 → 44	50	11 ¾" → 17 ¼"	19 ¾"	LED retrofit bulb E27 Lmax. 120mm - Ø max. 65mm max 18W Micro Twist E27 max 53W E27
	M24-2	Schermo in vetro per C024___.002.0000 Glass screen for		25	10"	
Terra / Floor	T024___.002.0000	40 → 64	130 → 170	15 ¾" → 25 ½"	51 ¼" → 67"	LED retrofit bulb E27 Lmax. 120mm - Ø max. 65mm max 23W Micro Twist E27 max 70W E27
	M24-3	Schermo in vetro per T024___.002.0000 Glass screen for		36	14 ¼"	

Fotometrie e Classi Energetiche disponibili www.panzeri.it / Photometric data and Energy Label available at www.panzeri.it

	CM Ø	H	INCHES Ø	H	LED 
Flessibile a LED per versioni a parete (su richiesta) Flexible LED for wall-mounted version (available on request)	2,5	35	1"	13 ½"	1,7W 3000K Ra80 160lm 220-240V

Per progetti, disponibili su richiesta versioni a parete con flessibile a LED, ottone o cromo, completo di driver e interruttore.
Wall-mounted version available on request in brass or chrome, includes flexible LED, complete with driver and switch.

CODICI COLORI DISPONIBILI / COLOUR CODES AVAILABLE

20 Ottone lucido Polished brass	22 Cromo Chrome	PARALUME • Norma di reazione al fuoco (CLASSE 1) UNI 8456/87 LAMPSHADE • Reaction to fire (CLASSE 1) UNI 8456/87
---	---------------------------	---



ROSONI E DECENTRAMENTI / OFFSET AND CANOPIES



M79D

Bianco
White

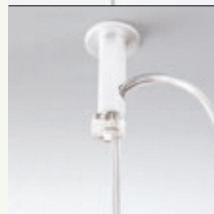
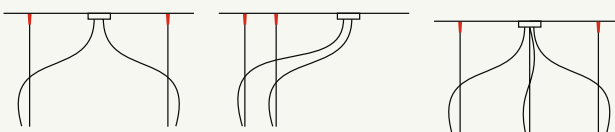

M75D

Bianco
White

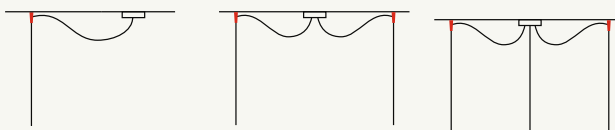

M75__

Disponibile con 1, 2, 3 fori - 1, 2 or 3 holes available

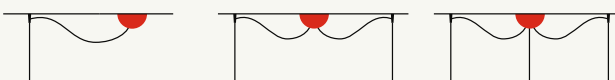

M7533/1

M7533/2

M7533/3

CODICI COLORI DISPONIBILI / COLOUR CODES AVAILABLE

3 2 Nichel
Nickel

3 3 Grigio metallizzato
Metallized grey



M79__
Bianco
White

Disponibile con 1, 2, 3 fori - 1, 2 or 3 holes available

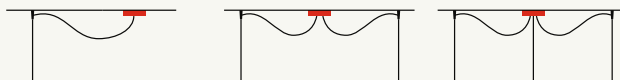

M7901/1

M7901/2

M7901/3

CODICI COLORI DISPONIBILI / COLOUR CODES AVAILABLE

0 1 Bianco
White

2 2 Cromo
Crome

3 2 Nichel
Nickel

3 3 Grigio metallizzato
Metallized grey

XM89__-03 LED MAX 3 LIGHTS

Rosone per sospensioni con solo cavo elettrico

Incluso driver 30W/24V

Canopy for electric cable suspensions

Driver 30W/24V included

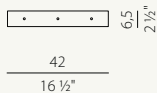

XM89__-05 LED MAX 5 LIGHTS

Rosone per sospensioni con solo cavo elettrico

Incluso driver 30W/24V

Canopy for electric cable suspensions

Driver 30W/24V included

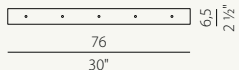

XM89__-06 LED MAX 6 LIGHTS

Rosone per sospensioni con solo cavo elettrico

Incluso driver 30W/24V

Canopy for electric cable suspensions

Driver 30W/24V included

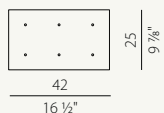

CODICI COLORI DISPONIBILI / COLOUR CODES AVAILABLE

0 1 Bianco
White

XM89__-03 MAX 3 LIGHTS
Rosone per sospensioni con solo cavo elettrico
Canopy for electric cable suspensions

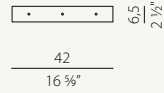

XM90__-03 MAX 3 LIGHTS
Rosone per sospensioni con solo cavo elettrico
A richiesta con driver 24V
Canopy for electric cable suspensions
With driver 24V on request
NOVELTY



XM89__-05 MAX 5 LIGHTS
Rosone per sospensioni con solo cavo elettrico
Canopy for electric cable suspensions

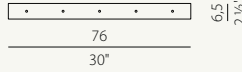

XM90__-07 MAX 7 LIGHTS
Rosone per sospensioni con solo cavo elettrico
A richiesta con driver 24V
Canopy for electric cable suspensions
With driver 24V on request
NOVELTY

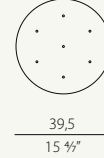

XM89__-06 MAX 6 LIGHTS
Rosone per sospensioni con solo cavo elettrico
Canopy for electric cable suspensions

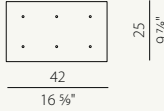

XM90__-12 MAX 12 LIGHTS
Rosone per sospensioni con solo cavo elettrico
A richiesta con driver 24V
Canopy for electric cable suspensions
With driver 24V on request
NOVELTY

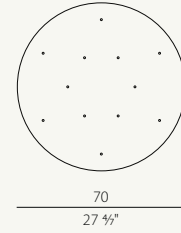

XM89__-09 MAX 9 LIGHTS
Rosone per sospensioni con solo cavo elettrico
A richiesta con driver 24V
Canopy for electric cable suspensions
With driver 24V on request
NOVELTY

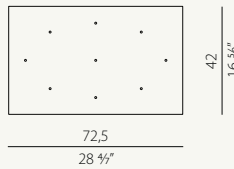

XM90__-21 MAX 21 LIGHTS
Rosone per sospensioni con solo cavo elettrico
A richiesta con driver 24V
Canopy for electric cable suspensions
With driver 24V on request
NOVELTY

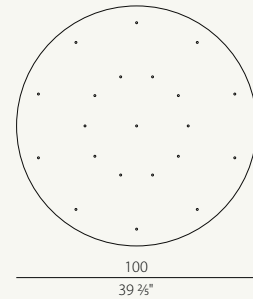

XM89__-15 MAX 15 LIGHTS
Rosone per sospensioni con solo cavo elettrico
A richiesta con driver 24V
Canopy for electric cable suspensions
With driver 24V on request
NOVELTY

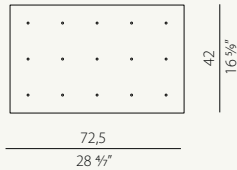

CODICI COLORI DISPONIBILI / COLOUR CODES AVAILABLE

01 Bianco
White

MATRICE DI COMPATIBILITA' ROSONI/APPARECCHI A SOSPENSIONE / CANOPIES/SUSPENDED FIXTURES MATRIX

NUMERO E TIPO DI APPARECCHI PER ROSONE / KIND AND FIXTURES NUMBER FOR CANOPY		
ROSONE/CANOPY	Candle, Olivia, Emma&Clio, Ely, Emy, Evy, Jazz (220V-240V)	Candle, Bella, Jazz, To-be (24V)
XM8901-03	3	
XM8901-03 LED		3
XM8901-05	5	
XM8901-05 LED		5
XM8901-06	6	
XM8901-06 LED		6
XM8901-09	9	a richiesta con driver 24V / with driver 24V on request
XM8901-15	15	a richiesta con driver 24V / with driver 24V on request
XM9001-03	3	a richiesta con driver 24V / with driver 24V on request
XM9001-07	7	a richiesta con driver 24V / with driver 24V on request
XM9001-12	12	a richiesta con driver 24V / with driver 24V on request
XM9001-21	21	a richiesta con driver 24V / with driver 24V on request
XM9201-01	1	prevedere driver 24V remoto/remote driver 24V needed

Verificare eventuali interferenze tra gli apparecchi installati / Check for any interference between the installed fixtures

L'Ufficio Tecnico Panzeri è disponibile a supporto della progettazione / Panzeri Technical Department is available to support the design

ROSONI E DECENTRAMENTI / OFFSET AND CANOPIES

Rosone a scomparsa / recessed canopy

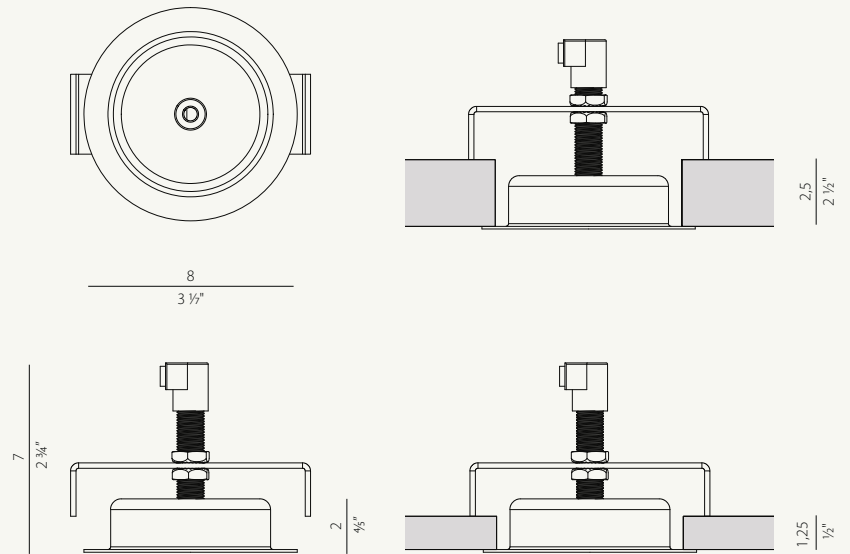
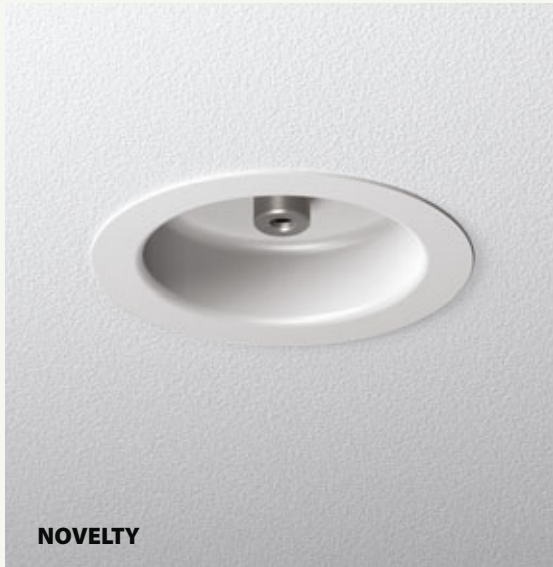

XM92__-01

Rosone a scomparsa per sospensioni con solo cavo elettrico, utilizzabile per tutti gli apparecchi a 24V prevedendo driver remoto. L'Ufficio Tecnico Panzeri è disponibile a supporto della progettazione.

Recessed canopy for electric cable suspensions.
Suitable for 24V fixtures: remote driver 24V needed.
Panzeri Technical Department is available to support the design.

CODICI COLORI DISPONIBILI / COLOUR CODES AVAILABLE

01 Bianco
White



VETRERIA

Arte vetraria veneziana, maestria e tecnica si coniugano per creare nuove opere artigianali, eredità della costante ricerca e innovazione tecnologica che in Panzeri tramandiamo da generazioni.

Venetian glassworking art, craftsmanship and technical skills are combined to create new artisan works, the legacy of constant research and technological innovation that we have been passing on for generations in Panzeri.



TATE

2009

Tate è un apparecchio a sospensione in vetro che riprende le forme classiche dei grandi chandelier, rileggendoli in chiave più attuale. Possibilità di sorgente LED. Disponibili come accessori gancio per apprendimento e fuscietta per coprire gli elementi della sospensione. Cromo, bianco e nero le finiture disponibili.

Tate is a suspended glass luminaire that recalls the design of classic big chandelier from a current point of view. LED lamps available on market. Ceiling hook and white cloth cover to hide suspension chain accessories available. Chrome, white and black finishes available.









TATE		2009				CE IP20 
	CODICE / CODE	CM Ø / A x B	H	INCHES Ø / A x B	H	FONTI LUMINOSE / LIGHT SOURCES
Sospensione / Suspension	Y-TAT-6L	90	75	35 1/2"	29 1/2"	6x LED retrofit bulb G9 Lmax. 60mm - Ø max. 17,5mm 6 x max 60W G9
	Y-TAT-8L	100	75	39 3/8"	29 1/2"	8x LED retrofit bulb G9 Lmax. 60mm - Ø max. 17,5mm 8 x max 60W G9
Parete / Wall	Y-TAT-2A	40 x 25	30	15 3/4" x 9 3/4"	11 3/4"	2x LED retrofit bulb G9 Lmax. 60mm - Ø max. 17,5mm 2 x max 60W G9
	YM10					Fusciacca bianca / White cloth cover
	YM12					Gancio per appendimento / Ceiling hook

Fotometrie e Classi Energetiche disponibili www.panzeri.it / Photometric data and Energy Label available at www.panzeri.it

COLORI DISPONIBILI / COLOURS AVAILABLE

Cromo Chrome	Bianco White	Nero Black	YM10	YM12
				

OUTDOOR

380 **BOX**

384 **DRACO**

376 **FOUR**

372 **LAMPyris**

389 **POTTER**

364 **RALPH**

RALPH

Studio Tecnico Panzeri 2011

Famiglia di apparecchi per esterni, IP65 nella versione con spina. Il paralume in rattan sintetico combina un'altissima resistenza alle condizioni climatiche più estreme e la bellezza della lavorazione intrecciata a mano. Studiata nei minimi dettagli, dall'attacco del diffusore in policarbonato a baionetta per facilitarne il ritiro in inverno ai numerosi accessori per il fissaggio a soffitto, parete e al suolo. Rosone, spina e moschettone di aggancio con o-ring inclusi nella fornitura delle sospensioni. Disponibile nelle versioni sospensione, tavolo, terra, picchetto. Paralume in bianco/grigio screziato o marrone, struttura in bianco o marrone, cavo di alimentazione arancione.

Outdoor lamps, the version with plug is IP65. The synthetic rattan lampshade combines a very high resistance to the most extreme weather conditions and the beauty of the hand-woven workmanship. Designed in even smallest details, from the bayonet fitting for an easy removal during the winter to many accessories for ceiling, wall and ground fixing. Canopy, plug and hooking carabiner with o-ring included in the suspension supply. Suspension, table, ground and picket versions are available. Lampshade in striated white/gray or brown, white or metallized brown structure, orange power supply cord.





RALPH Ø 35

Lampada da esterno-interno in rattan sintetico con diffusore in polimetilmetraccrilato (PMMA) trasparente, paralume in bianco/grigio screziato o marrone con cavo arancione.

Indoor/outdoor lamps in striated white/grey or brown synthetic rattan lampshade with clear polymethylmethacrylate (PMMA) diffuser and orange cable.



RALPH Ø 90





RALPH Ø 35

RALPH Ø 50

RALPH Ø 35

Sospensione IP65, cavo arancione 4,50m con spina.
In dotazione rosone, o-ring silicone e gancio per
molteplici appendimenti. A richiesta accessorio in
alluminio plastificato per appendimento a parete per
EL047_ _035.0000.

Suspension IP65, 4,50m orange cable with plug.
Canopy, silicone o-ring and hook use for multiple
fixing included. On request bracket in plasticized
aluminium to fix as a wall lamp for
EL047_ _035.0000 available.





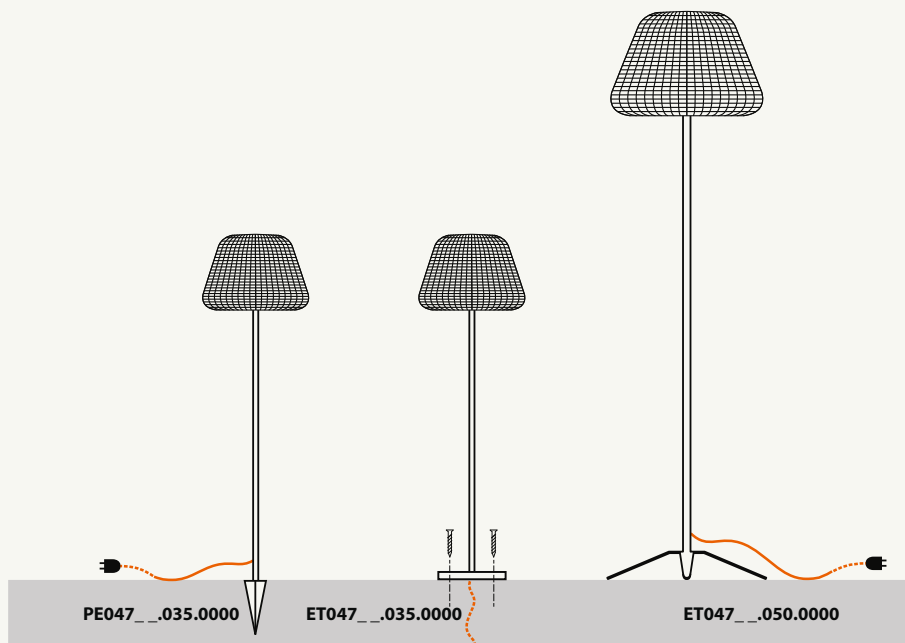

RALPH

Studio Tecnico Panzeri 2011

CE IP65* * Solo versione con spina / Only plug version

	CODICE / CODE	CM Ø	H	INCHES Ø	H	FONTI LUMINOSE / LIGHT SOURCES
Sospensione / Suspension	EL047__035.0000	35	25	13 3/4"	9 7/8"	LED retrofit bulb E27 Lmax. 125mm - Ø max. 65mm max 23W Micro Twist E27 max 53W E27
Incluso: 4,50m cavo, spina, rosone, O-Ring silicone e moschettone Included: 4,50m cable, plug, canopy, silicone O-Ring and hook	EL047__050.0000	50	34	19 3/4"	13 1/4"	LED retrofit bulb E27 Lmax. 125mm - Ø max. 65mm max 23W Micro Twist E27 max 53W E27
	EL047__090.0000	90	61	35 1/2"	24"	LED retrofit bulb E27 Lmax. 125mm - Ø max. 65mm max 23W Micro Twist E27 max 53W E27
Tavolo / Table	EC047__035.0000	35	58	13 3/4"	22 7/8"	LED retrofit bulb E27 Lmax. 125mm - Ø max. 65mm max 23W Micro Twist E27 max 53W E27
	Con Interruttore / With switch					
Terra / Floor	ET047__035.0000	35	115	13 3/4"	45 1/4"	LED retrofit bulb E27 Lmax. 125mm - Ø max. 65mm max 23W Micro Twist E27 max 53W E27
	Da fissare al suolo / To be fixed to the ground					
	No spina, no interruttore / No plug, no switch					
	PE047__035.0000	35	115	13 3/4"	45 1/4"	LED retrofit bulb E27 Lmax. 125mm - Ø max. 65mm max 23W Micro Twist E27 max 53W E27
	Da fissare al suolo / To be fixed to the ground					
	Con interruttore e spina / With switch and plug					
	ET047__050.0000	55	190	21 1/2"	74 3/4"	LED retrofit bulb E27 Lmax. 125mm - Ø max. 65mm max 23W Micro Twist E27 max 53W E27
	Con base, interruttore e spina / With base, switch and plug					
	M47__A	20,5	18,3	8"	7 1/4"	Staffa in alluminio plastificato per fissaggio a parete per art. EL047__035.0000 Bracket in plasticized aluminium to fix as a wall lamp for items EL047__035.0000
	M47T					Picchetto per fissare la lampada al terreno. Accessorio per art. ET047__050.0000 Peg to fix lamp to the ground. Accessory for items ET047__050.0000

Fotometrie e Classi Energetiche disponibili www.panzeri.it / Photometric data and Energy Label available at www.panzeri.it

CODICI COLORI DISPONIBILI / COLOUR CODES AVAILABLE

01 Bianco
White

Paralume bianco/grigio screziato
Lampshade white/grey striated

44 Marrone metallizzato
Metallized brown

Paralume marrone
Lampshade brown



LAMPyris

Lorenzo Giacomini 2014

Pensata per integrarsi totalmente nel verde, LAMPyris è un apparecchio da esterni IP65 che restituisce alla natura lo spazio che occupa al suolo. Si configura come una duna sulla quale il verde continua a crescere e dalla quale viene emessa luce diretta. Disponibile in marrone metallizzato.

Designed to be totally integrated into the green, LAMPyris is an IP65 outdoor luminaire that gives back to nature the space it occupies on the ground. It is configured as a dune on which the green continues to grow and from which direct light is emitted. Metallic brown finish is available.









LAMPyris

Lorenzo Giacomini 2014

  IP65 IK09 850°

	CODICE / CODE	CM A x B	H	INCHES A x B	H	FONTI LUMINOSE / LIGHT SOURCES
Terra / Floor	ET08044.000.0101	62 x 38,5	18	24 3/4" x 15 1/2"	7"	Potenza assorbita apparecchio / Luminaire power consumption 9W Flusso luminoso apparecchio / Luminaire luminous flux 500lm 3000K Ra80 220-240V

Fotometrie e Classi Energetiche disponibili www.panzeri.it / Photometric data and Energy Label available at www.panzeri.it

CODICI COLORI DISPONIBILI / COLOUR CODES AVAILABLE

44 Marrone metallizzato
Metallized brown



FOUR

Studio Tecnico Panzeri 2011



Design minimale per Four, apparecchio installabile a parete e soffitto IP44 in acciaio inox. Marrone metallizzato o bianco le finiture disponibili, accessorio per esigenze di dimmerazione ordinabile separatamente.

Four has a minimal design, IP44 wall-mounted and ceiling-mounted luminaire in stainless steel. Metallic brown or white finishes available. Accessory for dimming to be ordered separately.







FOUR

Studio Tecnico Panzeri 2011

  IP44

	CODICE / CODE	CM A x B	H	INCHES A x B	H	FONTI LUMINOSE / LIGHT SOURCES
Soffitto-parete Ceiling-wall	 EP044__000.0106	12 x 12	6	4 3/4" x 4 3/4"	2 3/8"	Potenza assorbita apparecchio / Luminaire power consumption 10W Flusso luminoso apparecchio / Luminaire luminous flux 630lm 3000K Ra80 220-240V
Accessorio dimmerabile	XM14/230	5,1 x 3,2	1,8	2" x 1 1/4"	5/8"	Dimmer per moduli LED a 230V 5÷100W/ Dimmer for 230V 5÷100W LED modules

Fotometrie e Classi Energetiche disponibili www.panzeri.it / Photometric data and Energy Label available at www.panzeri.it

CODICI COLORI DISPONIBILI / COLOUR CODES AVAILABLE

01 Bianco
White

44 Marrone metallizzato
Metallized brown



BOX

Box è un apparecchio di illuminazione a parete/soffitto IP44. In versione quadrata e tonda le caratteristiche che se ne apprezzano sono compattezza e dettaglio dello schermo trasparente che mostra la struttura interna. Bianco e nero le finiture disponibili.

Box is an IP44 wall/ceiling luminaire. In square and round versions the characteristics appreciated the most are compactness and the transparent screen that shows the internal structure. Black and white finishes available.







XR144-01



XQ144-02

BOX

LED **CE** IP65 IP44 IK08 850°

	CODICE / CODE	CM Ø / A x B	H	INCHES Ø / A x B	H	FONTI LUMINOSE / LIGHT SOURCES
Parete-soffitto / Wall ceiling	<input type="checkbox"/> XR144 - _ _	11	2,2	4 1/3"	7/8"	Potenza assorbita apparecchio / Luminaire power consumption 4,3W Flusso luminoso apparecchio / Luminaire luminous flux 344lm
	<input type="checkbox"/> XQ144 - _ _	11x11	2,2	4 1/3" x 4 1/3"	7/8"	3000K 110° Ra80 220-240V

Fotometrie e Classi Energetiche disponibili www.panzeri.it / Photometric data and Energy Label available at www.panzeri.it

CODICI COLORI DISPONIBILI / COLOUR CODES AVAILABLE

01 Bianco
White

02 Nero
Black



DRACO

Highlight 2012

Un cubo per installazione a parete dal design minimale IP54, che nasconde al suo interno un ingegnoso sistema ad alette orientabili per consentire la regolazione dell'apertura del fascio in emissione diretta e indiretta. Bianco, grigio metallizzato e marrone metallizzato le finiture disponibili.

A wall-mounted minimal IP54 cube, which hides an ingenious adjustable system to allow the regulation of the beam angle in direct and indirect light emission. White, metallized gray and metallized brown finishes are available.





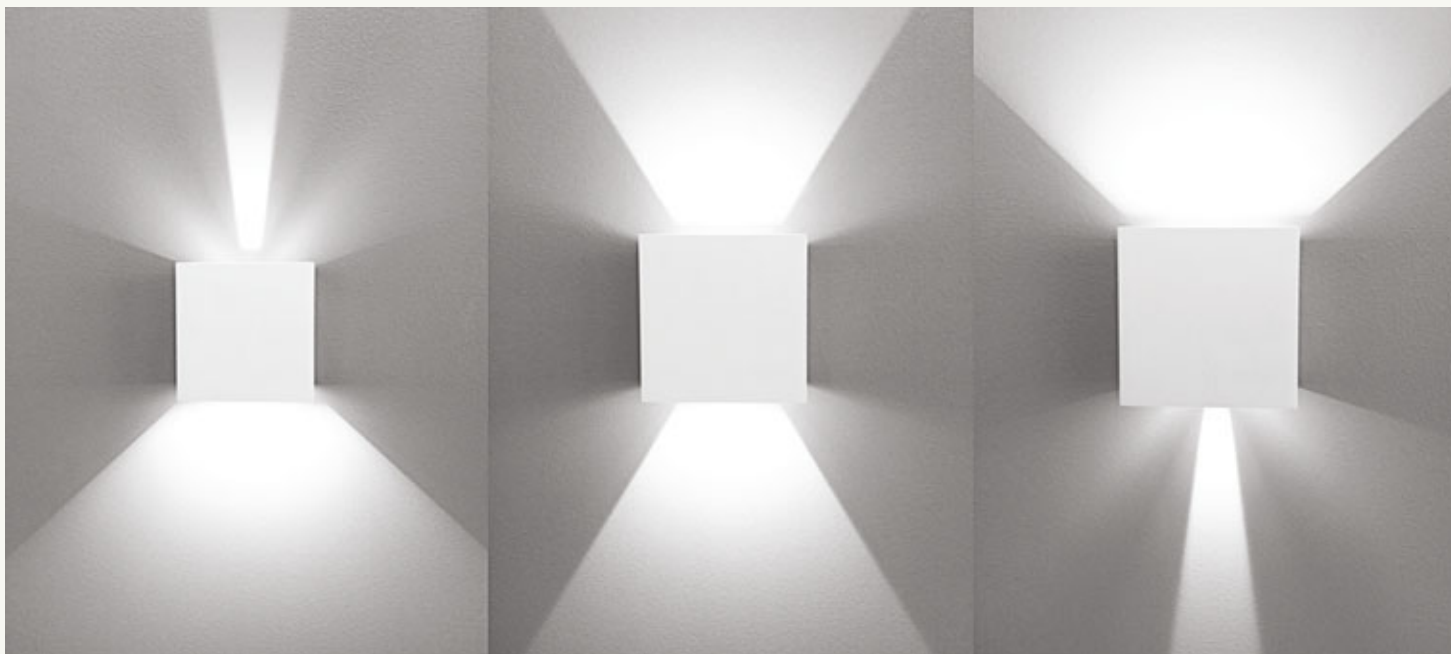

DRACO

Highlight 2012

  IP54

	CODICE / CODE	CM A x B	H	INCHES A x B	H	FONTI LUMINOSE / LIGHT SOURCES
Parete / Wall	EA054_...000.0101	10 x 10	10	4" x 4"	4"	Potenza assorbita apparecchio / Luminaire power consumption 9W Flusso luminoso apparecchio / Luminaire luminous flux 388lm 3000K Ra80 220-240V

Fotometrie e Classi Energetiche disponibili www.panzeri.it / Photometric data and Energy Label available at www.panzeri.it

CODICI COLORI DISPONIBILI / COLOUR CODES AVAILABLE

01 Bianco White	33 Grigio metallizzato Metallized grey	44 Marrone metallizzato Metallized brown
---------------------------	--	--



POTTER

Valerio Bottin - Enzo Panzeri 2011

Una lampada da terra in polietilene bianco per installazione in interno IP20 ed esterno IP65 che è anche una seduta. Potter è disponibile anche con sorgente LED RGB. Accessorio per il fissaggio a terra da ordinare separatamente.

White polyethylene floor lamp for indoor IP20/outdoor IP65 installation which is also a seat. Potter with RGB LED lighting source available. Accessory for ground fixing to be ordered separately.





POTTER

Valerio Bottin - Enzo Panzeri 2011

Registered Design

IP65 IP20

	CODICE / CODE	CM A x B	H	INCHES A x B	H	+ ELECTRIC OPTIONS:		
Lampada / Seduta Lamp / Stool	T04201.000.0000	80 x 70	55	31 ½" x 27 ½"	21 ¾"	LED retrofit bulb E27 Lmax. 140mm - Ø max. 65mm max 70W E27 + interruttore / Switch max 30W Superstar E27	IP20	
	ET04201.000.0000					LED retrofit bulb E27 Lmax. 140mm - Ø max. 65mm max 70W E27 max 30W Superstar E27	IP65	
	No interruttore / No switch							
	ET04201.000.0005					LED RGB max 8,2W 350mA 220-240V + remote control	IP65	
	M42	Picchetto per fissare la lampada al terreno / Peg to fix lamp to the ground						

Portata max 130 kg / Maximum load 130 kg

Fotometrie e Classi Energetiche disponibili www.panzeri.it / Photometric data and Energy Label available at www.panzeri.it

CODICI COLORI DISPONIBILI / COLOUR CODES AVAILABLE

01 Bianco
White



PROFILI

444 BROADWAY
416 BRONX
430 BROOKLYN
430 BROOKLYN OUT
424 BROOKLYN ROUND
430 BROOKLYN TRIM
436 BROOKLYN SPOT
476 CORNER
482 GIANO
400 JACKIE SPOT
466 MANHATTAN
446 NOLITA
446 NOLITA OUT
446 NOLITA TRIM
398 QUEENS
401 QUEENS COMPACT
402 QUEENS MINI
403 QUEENS SPOT
392 SOHO IN
393 SOHO OUT
397 SOHO SPOT MICRO
396 SOHO SPOT MICRO LOW
395 SOHO SPOT NANO
442 TRIBECA

SOHO IN



NOVELTY

Sistema di binari a bassa tensione 48V, disponibile in tre differenti lunghezze per applicazioni ad incasso. Il sistema è costruito in lega di alluminio estruso verniciato poliestere, predisposto per alloggiare i proiettori provvisti di adattatore 48V. Possibilità di regolazione DALI a richiesta. Il sistema è a sezione quadra, in colore nero. Disponibile un'ampia varietà di accessori e giunti di collegamento.

System of 48V electrified tracks, available in three different lengths for recessed use. The system is made of extruded aluminium alloy with polyester coating, suitable to host spotlights equipped with 48V adapter. Possibility of DALI dimming on request. The system is square-shaped, in black colour. Wide range of available accessories and joints.

CE IP20 850°

XM44602-100

Binario 48V DC per incasso trimless
Trimless recessed electrified track 48V DC

XM44602-200

XM44602-300

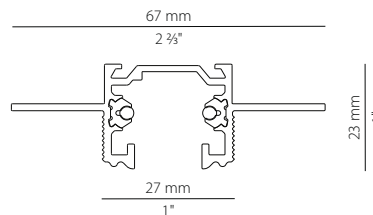

XM44602-ADX

Alimentazione destra
Right live-end

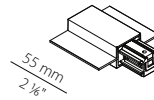

XM44602-ASX

Alimentazione sinistra
Left live-end

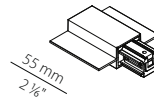

XM44602-A

Alimentazione centrale
Central connector

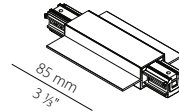

XM44502-UE

Giunto lineare
Straight joint



XM44502-UM

Giunto lineare senza contatti
Mechanical straight joint



XM445-TR

Trasformatore elettronico
Electronic transformer

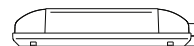

Vin 220-240V AC out 48V DC - 120 W

XM445-TRD

Trasformatore elettronico DALI
DALI Electronic transformer

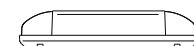

Vin 220-240V AC out 48V DC - 150 W

XM44602-E

Terminale di chiusura
End cap



XM446-P

Piattina
Plate

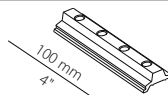

CODICI COLORI DISPONIBILI / COLOUR CODES AVAILABLE

02 Nero
Black

SOHO OUT



Sistema di binari a bassa tensione 48V, disponibile in tre differenti lunghezze per applicazioni a soffitto/parete e a sospensione. Il sistema è costruito in lega di alluminio estruso verniciato poliestere, predisposto per alloggiare i proiettori provvisti di adattatore 48V. Possibilità di regolazione DALI a richiesta. Il sistema è a sezione quadra, in colore bianco e nero. Disponibile un'ampia varietà di accessori e giunti di collegamento.

System of 48V electrified tracks, available in three different lengths for ceiling/wall or suspended use. The system is made of extruded aluminium alloy with polyester coating, suitable to host spotlights equipped with 48V adapter. Possibility of DALI dimming on request. The system is square-shaped, in white or black colour. Wide range of available accessories and joints.

NOVELTY

CE IP20 850°

XM44501-100
XM44502-100

Binario 48V DC
Electrified track 48V DC

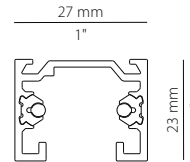

XM44501-200
XM44502-200

XM44501-300
XM44502-300

XM44501-ADX
XM44502-ADX

Alimentazione destra
Right live-end

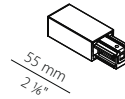

XM44501-ASX
XM44502-ASX

Alimentazione sinistra
Left live-end

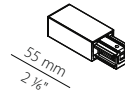

XM44501-A
XM44502-A

Alimentazione centrale
Central connector

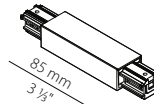

XM44501-LI
XM44502-LI

Giunto L interno
Inside L joint

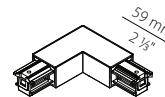

XM44501-LE
XM44502-LE

Giunto L esterno
Outside L joint

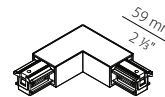

XM44501-UE
XM44502-UE

Giunto lineare
Straight joint



XM44501-UM
XM44502-UM

Giunto lineare senza contatti
Mechanical straight joint



XM445-TR

Trasformatore elettronico
Electronic transformer

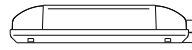

Vin 220-240V AC out 48V DC - 120 W

XM445-TRD

Trasformatore elettronico DALI
DALI Electronic transformer

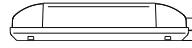

Vin 220-240V AC out 48V DC - 150 W

XM44501-E
XM44502-E

Terminale di chiusura
End cap



XM44501-S
XM44502-S

Kit di sospensione c/cavo acciaio mm 2000
Suspension kit w/steel wire mm 2000

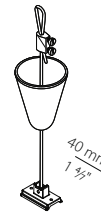

XM44501-K
XM44502-K

Kit attacco soffitto/parete (coppia)
Ceiling/wall kit (pair)



CODICI COLORI DISPONIBILI / COLOUR CODES AVAILABLE

01 Bianco
White

02 Nero
Black

SOHO SPOT NANO



PROIETTORE LED



Proiettore in pressofusione di alluminio con LED ad alta efficienza e adattatore integrato per binario elettrificato a bassa tensione 48V. Cilindro antiabbagliamento e vetro zigrinato di serie. Riflettore termoplastico metallizzato a specchio con ottica a fascio medio. Disponibile nella versione 3000K e nei colori bianco e nero.

Die-cast aluminium spotlight with high efficiency LED and integrated adapter for 48V low voltage electrified track. Standard anti-glare snoot and prismatic spread lens. Mirror-metallized thermoplastic reflector with flood light beam. Available 3000K version, in white and black colours.

NOVELTY

LED CE IP20  850° 

B75201.007.2516

B75202.007.2516

Potenza assorbita apparecchio / Luminaire power consumption 6,5W
Flusso luminoso apparecchio / Luminaire luminous flux 425lm
3000K 34° Ra90 48V DC

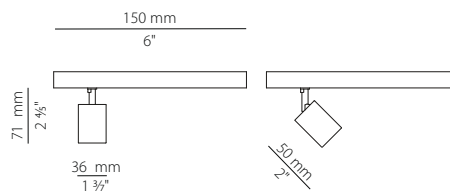

CODICI COLORI DISPONIBILI / COLOUR CODES AVAILABLE

01 Bianco
White

02 Nero
Black

SOHO SPOT MICRO LOW

PROIETTORE LED



Proiettore in pressofusione di alluminio con LED ad alta efficienza e adattatore integrato per binario elettrificato a bassa tensione 48V. Cilindro antiabbagliamento e vetro zigrinato di serie. Riflettore termoplastico metallizzato a specchio con ottica standard a fascio medio e ottiche per fascio stretto o largo disponibili su richiesta. Disponibile nella versione 3000K e nei colori bianco e nero.

Die-cast aluminium spotlight with high efficiency LED and integrated adapter for 48V low voltage electrified track. Standard anti-glare snoot and prismatic spread lens. Mirror-metallized thermoplastic reflector with flood standard light beam and spot or wide flood optics available on request. Available in 3000K version, in white and black colours.

NOVELTY

LED CE IP20 850°

B75301.018.2516

B75302.018.2516

Potenza assorbita apparecchio / Luminaire power consumption 18W
Flusso luminoso apparecchio / Luminaire luminous flux 1252lm
3000K 30° Ra90 48V DC

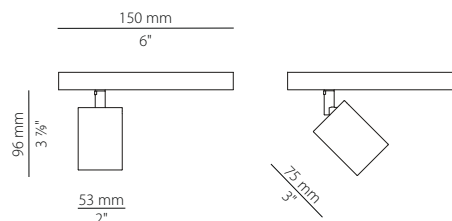

Accessori: ottiche intercambiabili / Replaceable optics accessories:

XMR10

16°

Mirror Metallized

XMR11

45°

Mirror Metallized

XMR12

Cilindro interno color oro satinato

Inner satin gold cylinder

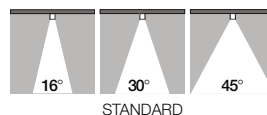

CODICI COLORI DISPONIBILI / COLOUR CODES AVAILABLE

01 Bianco
White

02 Nero
Black

SOHO SPOT MICRO

PROIETTORE LED



Proiettore in pressofusione di alluminio con LED ad alta efficienza e adattatore integrato per binario elettrificato a bassa tensione 48V. Cilindro antiabbagliamento e vetro zigrinato di serie. Riflettore termoplastico metallizzato a specchio con ottica standard a fascio medio e ottiche per fascio stretto o largo disponibili su richiesta. Disponibile nella versione 3000K e nei colori bianco e nero.

Die-cast aluminium spotlight with high efficiency LED and integrated adapter for 48V low voltage electrified track. Standard anti-glare snoot and prismatic spread lens. Mirror-metallized thermoplastic reflector with flood standard light beam and spot or wide flood optics available on request. Available in 3000K version, in white and black colours.

NOVELTY

LED CE IP20 850°

B75401.021.2516

B75402.021.2516

Potenza assorbita apparecchio / Luminaire power consumption 21W
Flusso luminoso apparecchio / Luminaire luminous flux 1435lm
3000K 30° Ra90 48V DC

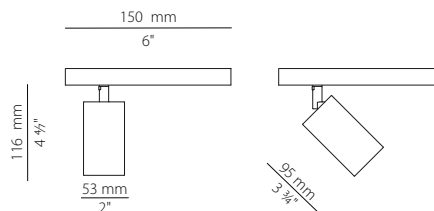

Accessori: ottiche intercambiabili / Replaceable optics accessories:

XMR10

16°

Mirror Metallized



46 mm
1 3/4"

XMR11

45°

Mirror Metallized

XMR12

Cilindro interno color oro satinato
Inner satin gold cylinder

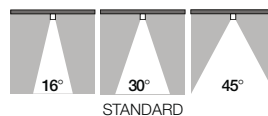

CODICI COLORI DISPONIBILI / COLOUR CODES AVAILABLE

01 Bianco
White

02 Nero
Black

UGR < 16 in funzione delle condizioni di installazione
UGR < 16 depending on installation conditions

Fotometrie e Classi Energetiche disponibili www.panzeri.it
Photometric data and Energy Label available at www.panzeri.it

QUEENS



Sistema di binari trifase a tre accensioni (tensione di rete 230/250V, tensione di rete industriale 380/440V, carico complessivo 16A) disponibile in tre differenti lunghezze per applicazioni a plafone e a sospensione. Il sistema è costruito in lega di alluminio estruso con cavi conduttori in rame alloggiati all'interno di profilati estrusi in pvc ad alta resistenza di isolamento. Il sistema è a sezione quadra in colore bianco, nero e comprende un'ampia varietà di accessori e giunti di collegamento che lo rendono ideale nella progettazione illuminotecnica per flessibilità e versatilità.

System of three-phase tracks with three circuits (power supply 230/250V, industrial power supply 380/440V, total load 16A) available in three different lengths for installation at the ceiling or at the wall. The system is made of extruded aluminium alloy with copper wires located inside the extruded PVC profiles with high insulating properties. The system is square-shaped in colour white, black and includes a wide range of accessories and joints that makes it extremely flexible and versatile in lighting design.

CE IP20 850° □

XM7501-100
XM7502-100

Binario trifase
Three - phase track

XM7501-200
XM7502-200

XM7501-300
XM7502-300

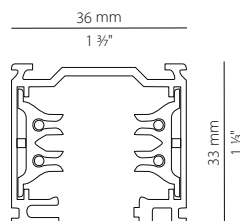

XM7601
XM7602

Adattatore elettromeccanico 6A, portata 10kg
Electro / mechanical adapter 6A, load 10kg

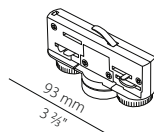

XM76ADX01
XM76ADX02

Alimentazione destra
Right live-end

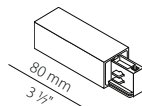

XM76ASX01
XM76ASX02

Alimentazione sinistra
Left live-end

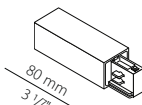

XM76A01
XM76A02

Alimentazione centrale e giunto lineare
Central connector and straight joint

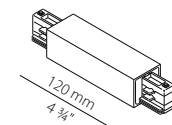

XM76LI01
XM76LI02

Giunto L interno
Inside L joint

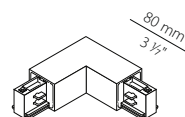

XM76LE01
XM76LE02

Giunto L esterno
Outside L joint

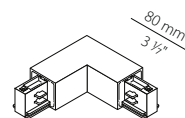

XM76TDX01
XM76TDX02

Giunto T destro
Right T joint

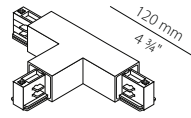

XM76TSX01
XM76TSX02

Giunto T sinistro
Left T joint

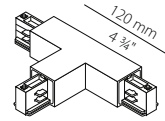

XM76F01
XM76F02

Giunto flessibile
Flexible joint

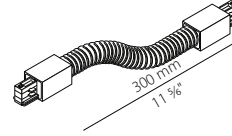

XM76U01
XM76U02

Giunto lineare senza contatti
Mechanical straight joint



XM76B01
XM76B02

Adattatore meccanico con bloccacavo automatico
Mechanical adapter with automatic locking

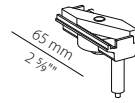

XM76S01
XM76S02

Kit sospensione c/ cavo acciaio mm 2000,
piattina mm 60 e bloccacavo automatico
Suspension kit w/ steel wire mm 2000 and
mm 60 plate and automatic locking

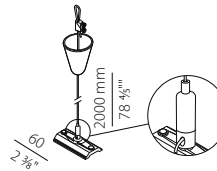

XM76X01
XM76X02

Giunto X
X joint

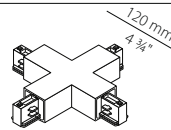

XM76M01
XM76M02

Giunto mobile
Mobile joint

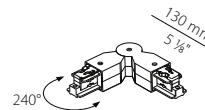

XM76Q01
XM76Q02

Giunto lineare con contatti e blocco
Electrical straight joint with stop

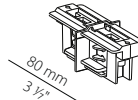

XM76K

Kit attacco soffitto
Ceiling kit



XM76E01
XM76E02

Terminale di chiusura
End cap



XM76C01
XM76C02

Copertura binario mm 1000
Track cover mm 1000

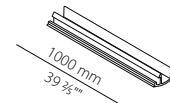

CODICI COLORI DISPONIBILI / COLOUR CODES AVAILABLE

01 Bianco
White

02 Nero
Black

JACKIE SPOT

SPOTLIGHT FOR TRACK

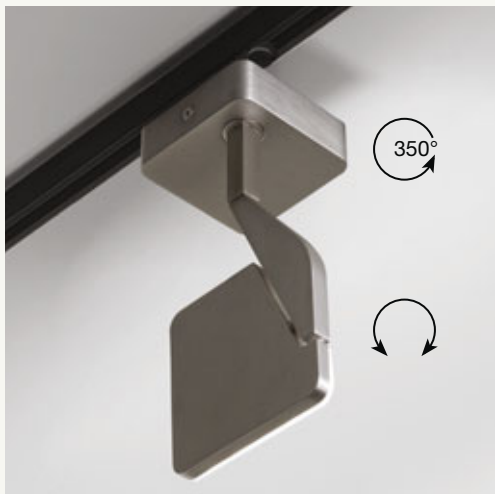

Faretto in pressofusione di alluminio per binario elettrificato. Diffusore in materiale acrilico con perimetro luminoso e doppia serigrafia studiata per ottimizzare il fascio e ridurre l'abbagliamento. Fascio luminoso orientabile generato da 1 modulo LED composto da 18 diodi. Potenza apparecchio 8,5W (702lm). Struttura rifinita con vernice poliacrilica in bianco, rosso o nero o spazzolato e verniciato colore titanio. Testa rotante su 2 assi grazie a un doppio snodo anche per luce indiretta.

Spotlight in die-cast aluminium for electrified track. Diffuser in acrylic material with luminous perimeter and double screen serigraphy, designed to optimize the beam and reduce the glaring. Swivelling light beam created by 1 LED module consisting of 18 diodes. Luminaire power 8.5W (702lm). Structure finished with polyacrylic paint in white, red or black, or brushed and finished titanium. Rotating head on 2-axis through a double joint able to make also indirect light.

LED CE IP20

B07701.000.0101
B07702.000.0101
B07703.000.0101
B07730.000.0101

Potenza assorbita apparecchio / Luminaire power consumption 8,5W
 Flusso luminoso apparecchio / Luminaire luminous flux 702lm
 3000K Ra80 220-240V

CODICI COLORI DISPONIBILI / COLOUR CODES AVAILABLE

01 Bianco White	02 Nero Black	03 Rosso Red	30 Titanio Titanium
---------------------------	-------------------------	------------------------	-------------------------------

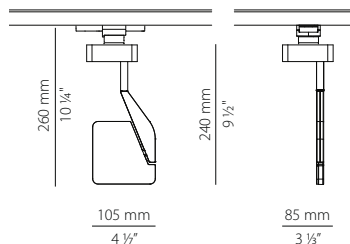

Fotometrie e Classi Energetiche disponibili www.panzeri.it
 Photometric data and Energy Label available at www.panzeri.it

QUEENS COMPACT

PROIETTORE LED



Proiettore in pressofusione di alluminio a dissipazione termica passiva per binario elettrificato trifase, con LED ad alta efficienza e adattatore integrato. Può essere ruotato rispetto all'asse verticale fino a 355° e di 90° verso l'alto. Riflettore termoplastico metallizzato a specchio con ottica standard a fascio medio e ottiche per fascio stretto, largo o molto largo disponibili su richiesta. Disponibile nelle versioni 3000K e 4000K e nei colori bianco e nero.

Die-cast aluminium spotlight with passive thermal dissipation for three-phase electrified track, equipped with high efficiency LED and integrated adapter. It can rotate up to 355° with respect to the vertical axis and pivot up to 90° upwards. Mirror-metallized thermoplastic reflector with flood standard light beam and spot, wide flood or extra wide flood optics available on request. Available in 3000K and 4000K versions, in white and black colours.

LED CE IP20 850° □

XM751-30-01-3K
XM751-30-02-3K

Potenza assorbita apparecchio / Luminaire power consumption 30W
Flusso luminoso apparecchio / Luminaire luminous flux 2552lm
3000K 29° Ra85 220-240V

XM751-30-01-4K
XM751-30-02-4K

Potenza assorbita apparecchio / Luminaire power consumption 30W
Flusso luminoso apparecchio / Luminaire luminous flux 2617lm
4000K 29° Ra85 220-240V

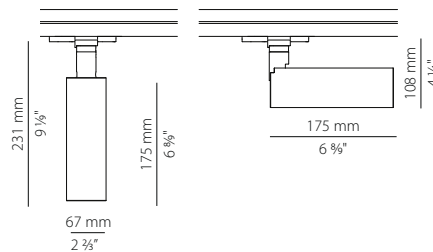

Accessori: ottiche intercambiabili / Replaceable optics accessories:

XMR5 20° Mirror Metallized
XMR6 29° Mirror Metallized
XMR7 42° Mirror Metallized
XMR8 61° White

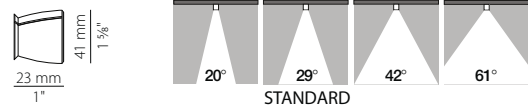

CODICI COLORI DISPONIBILI / COLOUR CODES AVAILABLE

01 Bianco
White

02 Nero
Black

• UGR < 16 in funzione delle condizioni di installazione
UGR < 16 depending on installation conditions

Fotometrie e Classi Energetiche disponibili www.panzeri.it
Photometric data and Energy Label available at www.panzeri.it

QUEENS MINI

PROIETTORE LED



Proiettore in pressofusione di alluminio a dissipazione termica passiva con adattatore per binario elettrificato trifase o con basetta per applicazioni a soffitto o a parete, equipaggiato con LED ad alta efficienza. Può essere ruotato rispetto all'asse verticale di 355° e di 90° verso l'alto. Cilindro antiabbagliamento di serie. Riflettore termoplastico metallizzato a specchio con ottica standard a fascio medio e ottiche per fascio stretto o largo disponibili su richiesta. Disponibile nella versione 3000K e nei colori bianco e nero.

Die-cast aluminium spotlight with passive thermal dissipation with adapter for three-phase electrified track or with base for wall or ceiling applications, equipped with high efficiency LED. It can rotate up to 355° with respect to the vertical axis and pivot up to 90° upwards. Standard anti-glare snoot. Mirror-metallized thermoplastic reflector with flood standard light beam and spot or wide flood optics available on request. Available in 3000K version, in white and black colours.

LED CE IP20 850° □

XM748-12-01-3K
XM748-12-02-3K

Potenza assorbita apparecchio / Luminaire power consumption 12W
Flusso luminoso apparecchio / Luminaire luminous flux 1221lm
3000K 30° Ra90 220-240V

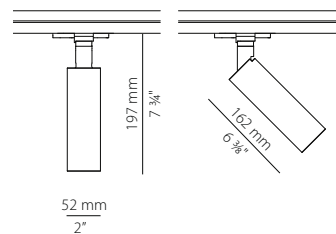

XM748-9-01-3K
XM748-9-02-3K

Potenza assorbita apparecchio / Luminaire power consumption 9W
Flusso luminoso apparecchio / Luminaire luminous flux 972lm
3000K 30° Ra90 220-240V

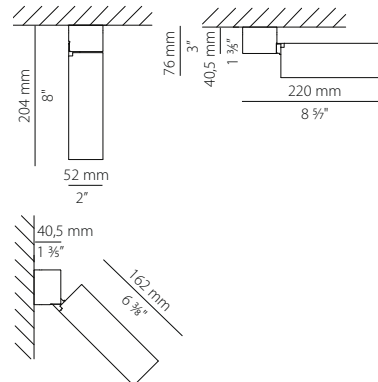

Accessori: ottiche intercambiabili / Replaceable optics accessories:

- XMR5** 24° Mirror Metallized
- XMR6** 30° Mirror Metallized
- XMR7** 45° Mirror Metallized

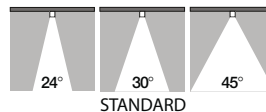
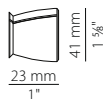

CODICI COLORI DISPONIBILI / COLOUR CODES AVAILABLE

- 01** Bianco / White
- 02** Nero / Black

UGR < 11 in funzione delle condizioni di installazione
UGR < 11 depending on installation conditions

Fotometrie e Classi Energetiche disponibili www.panzeri.it
Photometric data and Energy Label available at www.panzeri.it

QUEENS SPOT

PROIETTORE LED



Proiettore in pressofusione di alluminio a dissipazione termica passiva per binario elettrificato trifase, con LED ad alta efficienza e adattatore integrato. Può essere ruotato rispetto all'asse verticale fino a un'ampiezza di 355° e di 90° verso l'alto. Riflettore termoplastico metallizzato a specchio con ottica standard a fascio medio e ottiche per fascio stretto, largo o molto largo disponibili su richiesta. Disponibile nelle versioni 3000K e 4000K e nei colori bianco e nero.

Die-cast aluminium spotlight with passive thermal dissipation for three-phase electrified track, equipped with high efficiency LED and integrated adapter. It can rotate up to 355° with respect to the vertical axis and pivot up to 90° upwards. Mirror-metallized thermoplastic reflector with flood standard light beam and spot, wide flood or extra wide flood optics available on request. Available in 3000K and 4000K versions, in white and black colours.

LED CE IP20 850° □

XM743-43-01-3K
XM743-43-02-3K

Potenza assorbita apparecchio / Luminaire power consumption 43W
Flusso luminoso apparecchio / Luminaire luminous flux 4940lm
3000K 30° Ra85 220-240V

XM743-43-01-4K
XM743-43-02-4K

Potenza assorbita apparecchio / Luminaire power consumption 43W
Flusso luminoso apparecchio / Luminaire luminous flux 5029lm
4000K 30° Ra85 220-240V

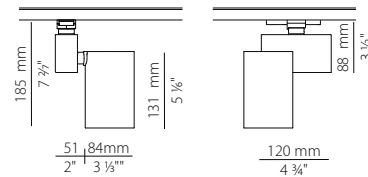

Accessori: ottiche intercambiabili / Replaceable optics accessories:

XMR1	17°	Mirror Metallized
XMR2	30°	Mirror Metallized
XMR3	55°	Mirror Metallized
XMR4	70°	White

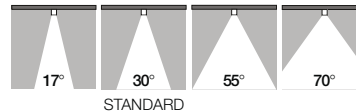
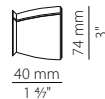

CODICI COLORI DISPONIBILI / COLOUR CODES AVAILABLE

01 Bianco White	02 Nero Black
---------------------------	-------------------------



CANDLE JAZZ

M09501.000.0000
LED retrofit bulb G9
Lmax. 60mm
Ø max. 17,5mm
Max 48W G9

+ **XM76**__

M08901.000.0000
LED retrofit bulb G9
Lmax. 60mm
Ø max. 17,5mm
Max 48W G9

+ **XM76**__

OLIVIA, EMMA & CLIO

M097/M091/M094__**000.0200**
LED bulb 8W E27 2700K Ra80
1050lm 220-240V Not dimmable
Included
Max 57 W E27

+ **XM76**__

LINE

L036__**000.0100**
LED bulb 9W GU10 3000K Ra80
840lm 110-240V Not dimmable
Included

+ **XM76**__

TWO

L038__**000.0106**
Potenza assorbita apparecchio
Luminaire power consumption 10W
Flusso luminoso apparecchio
Luminaire luminous flux 630lm
3000K Ra80 220-240V

+ **XM76**__



ONE

L037__000.0101
Potenza assorbita apparecchio
Luminaire power consumption 15W
Flusso luminoso apparecchio
Luminaire luminous flux 1097lm
3000K Ra80 220-240V

+ **XM76__**



WILLY

L076__040.0000
LED retrofit bulb E27
Lmax. 120mm - Ø max. 65mm
max 23W Micro Twist E27
max 150W E27

+ **XM76__**
+ **XM76B__**

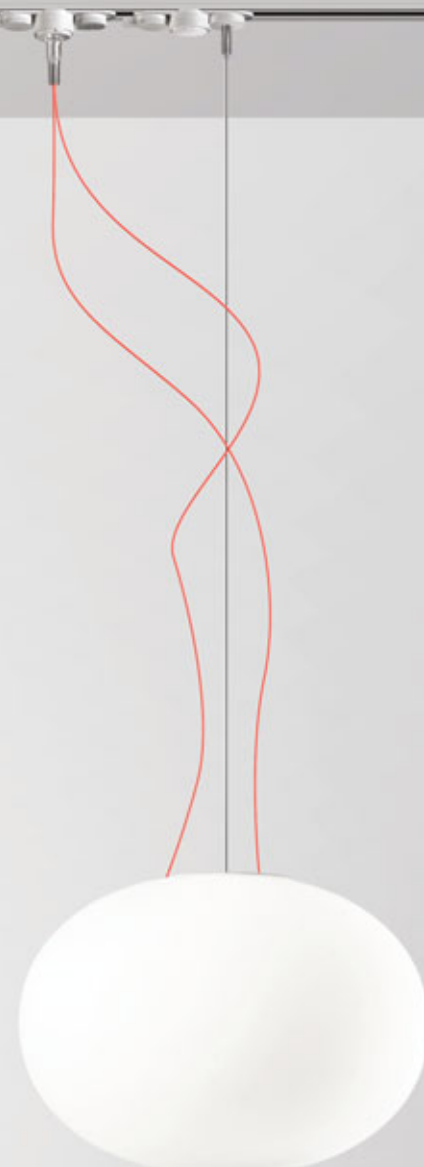

GILBERT

L06501.022.0000
LED retrofit bulb G9 Lmax. 60mm
Ø max. 17,5mm
Max 60W G9

L06501.037.0000
LED retrofit bulb E27
Lmax. 140mm - Ø max. 65mm
max 18W Micro Twist E27
max 150W E27

L06501.045.0000
LED retrofit bulb E27
Lmax. 140mm - Ø max. 65mm
max 23W Micro Twist E27
max 150W E27

+ **XM76__**
+ **XM76B__**

PROFILI

Sistemi modulari in alluminio estruso verniciato per installazione a plafone, sospensione e incasso a scomparsa totale o con bordo per applicazione nel cartongesso e/o laterizio. Emissione luminosa con diffusore in policarbonato opale, microprismato. Possibilità didiffusione della luce per riflessione interna. Doppio schermo: il primo monouso per rasatura, stuccatura e verniciatura, il secondo per definire l'emissione luminosa. Possibili applicazioni in verticale od orizzontale. A disposizione elementi di giunzione, angoli 90° orizzontale/verticali oppure giunzioni a T o giunzioni a X. Nella versione a LED possibilità di avere gli angoli illuminati. Disponibili farfalle micro regolabili per una corretta e facile installazione nel cartongesso. Illuminazione a LED con sistema di fissaggio rapido per semplificare l'installazione delle parti elettriche. Svariate opzioni di elettrificazioni: dimmerabile e su richiesta versioni con emergenza integrata.

Modular system in extruded aluminum for ceiling, suspension trim and trimless installation with false ceiling and/or brick. Option of diffused light with an opal or microprismatic polycarbonate. Light scattering by internal reflection available. Two screens: the first disposable for shaving, plastering and painting, the second definitive in opal or microprismatic polycarbonate. Vertical or horizontal installation possible. Optional 90° horizontal/vertical angle or T-junction and X-junction joining segments. In the LED version possibility to have illuminated corners. Available adjustable micro wing nuts for correct and easy installation in drywall. LED lighting with quick fastening system for easy installation of the electrical parts. Various options of electrification are available: dimmable and on-request versions with integrated emergency.



I CINQUE PLUS DEL SISTEMA PROFILI THE FIVE ADVANTAGES OF THE PROFILE SYSTEM

1 MICROREGOLAZIONE MICRO ADJUSTMENT

Particolare sistema di fissaggio con farfalle a molla micro regolabile, che permette di adattarsi a vari spessori di cartongesso e di facile installazione.

Special fastening system with adjustable spring micro wing nuts that allows for various heights of false ceiling and therefore makes installation simple.

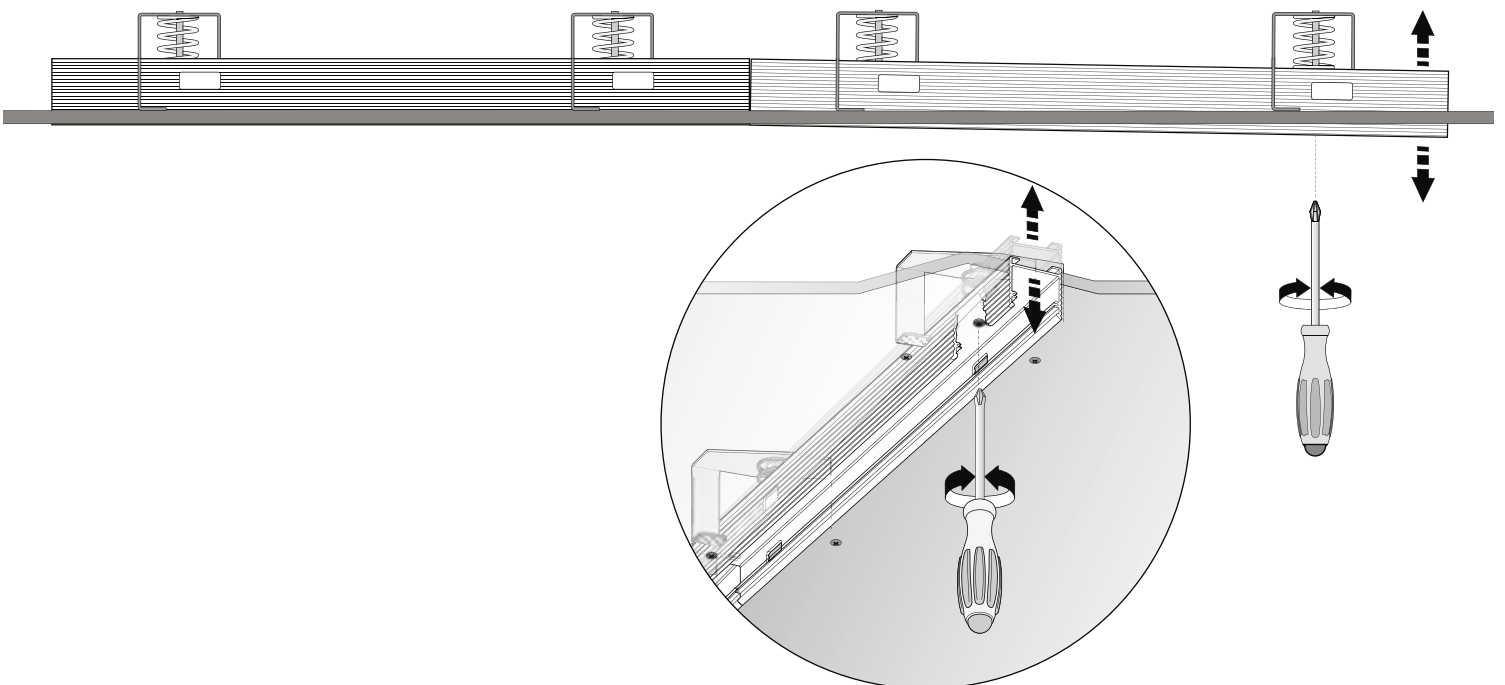

2 DOPPIO SCHERMO DUAL SCREEN

In dotazione schermo opaco monouso per facilitare le operazioni di assemblaggio: rasatura - stuccatura - verniciatura. Al termine delle precedenti operazioni verrà sostituito con il diffusore in policarbonato o microprismato.

The system includes a disposable matt screen for easy assembly: shaving - plastering - painting. After installation this screen is replaced with a polycarbonate or microprismatic diffuser.



3 FISSAGGIO RAPIDO FAST INSTALLATION

Particolari alette a molla che permettono il rapido assemblaggio dei supporti elettrificati delle sorgenti luminose all'interno dell'estruso in alluminio.

Special spring tabs that allow the rapid assembly of the powered supports of the light sources inside the extrusion in aluminum.

4 ELEMENTI DI GIUNZIONE
JUNCTION ELEMENTS

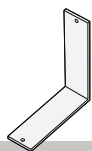

XM2033/34-ANG



XM2033-U90

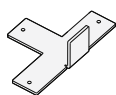

XM2033-UT

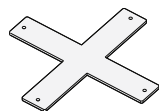

XM2033-X





5 **ANGOLI ILLUMINATI**
ILLUMINATED CORNERS

Moduli di giunzione elettrificati con LED e relativo gruppo di alimentazione

Junction modules powered LED and relative power supplies.

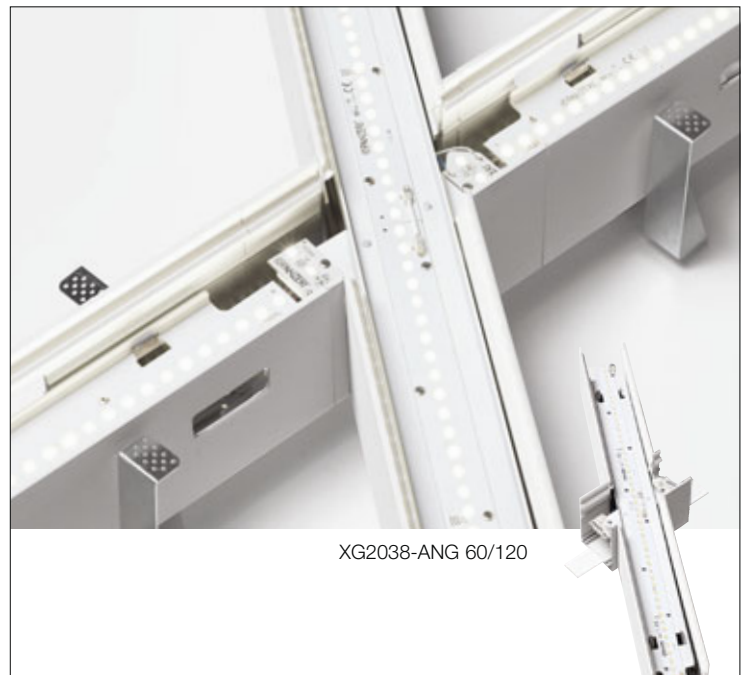
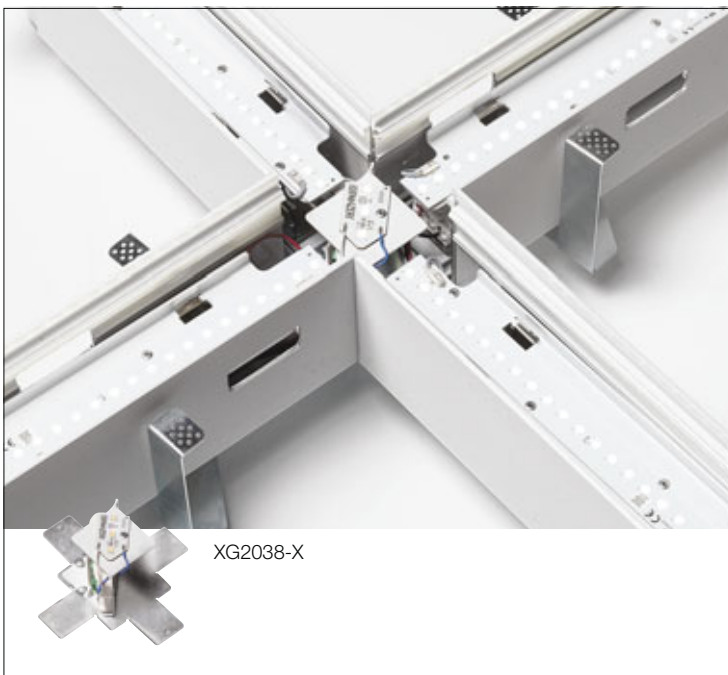
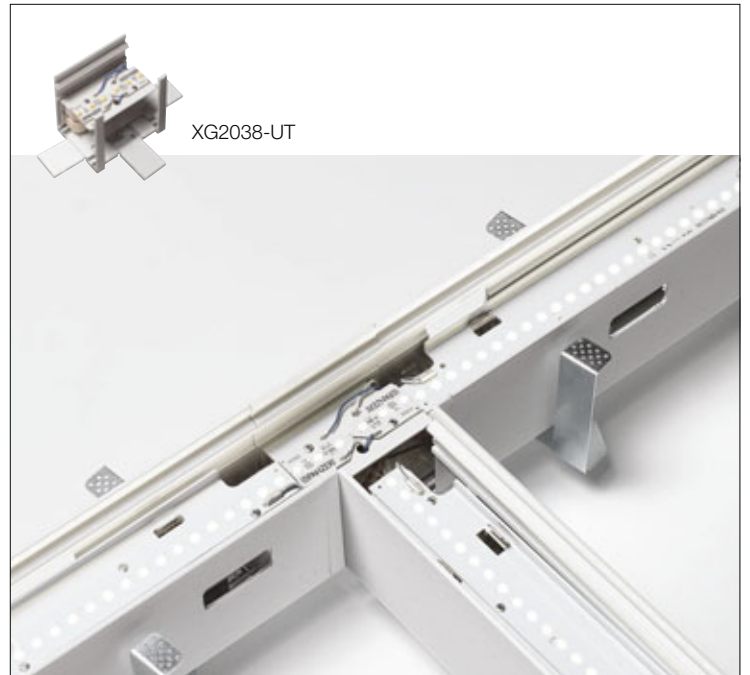
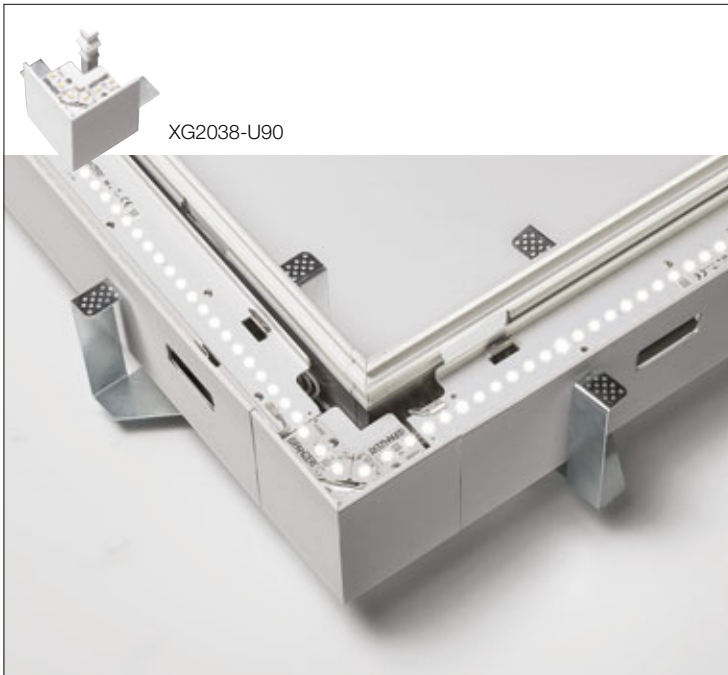



QUEENS XM7501	CORNER XG2045	BRONX XG2047	BROOKLYN XG2033	BROOKLYN TRIM XG2034	BROOKLYN OUT XP2033	BROADWAY XP2048	TRIBECA XG2047
-------------------------	-------------------------	------------------------	---------------------------	--------------------------------	-------------------------------	---------------------------	--------------------------

JACKIE SPOT
B077

QUEENS MINI
XM748-169

SOHO OUT
XM44602

SOHO SPOT NANO
B752

SOHO SPOT MICRO
B754

BROOKLYN SPOT
XM2033 SPOT



NOLITA
XG2038

NOLITA TRIM
XG2039

NOLITA OUT
XP2038

MANHATTAN
XG2044

GIANO
XP246



BRONX

Made in Italy

Bronx è un profilo in alluminio ad incasso, caratterizzato dalla sorgente luminosa arretrata, che crea una linea di luce sottile solo 29mm. L'estruso è studiato per consentire l'installazione su pannelli in cartongesso di diversi spessori, grazie alla possibilità di posizionare gli elementi di fissaggio su due diversi livelli. La sorgente luminosa è inserita all'interno del diffusore in policarbonato estruso, rimovibile a scatto, permettendo una semplice installazione.

Bronx is a recessed aluminum profile, characterized by the recessed light source, which creates a thin line of light only 29mm wide. The extrusion is designed to allow installation on plasterboard panels of different thicknesses, thanks to the possibility of positioning the fixing elements on two different levels. The light source is inserted inside the extruded polycarbonate diffuser, removable by snap, allowing a simple installation.



BRONX

XG247 TRIMLESS PROFILE

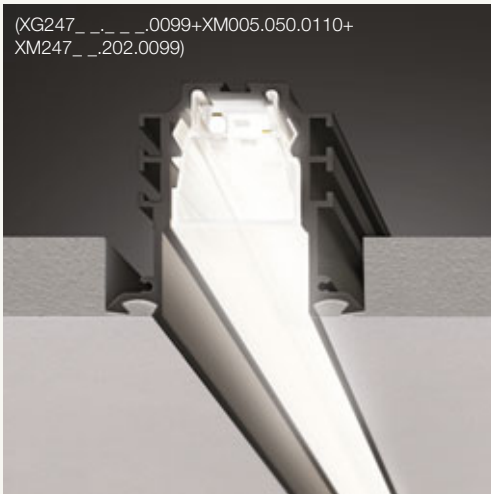

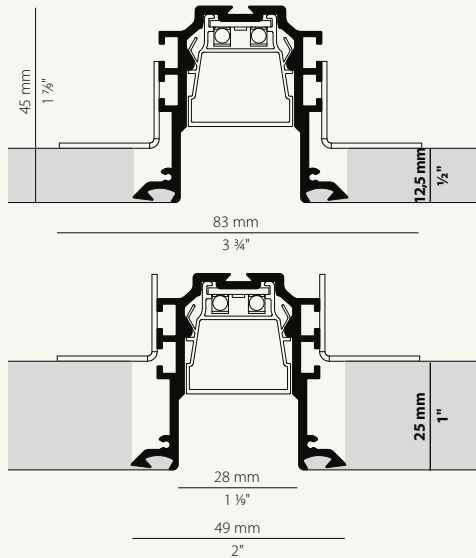

(XG247_..._0099+XM005.050.0110+
XM247_..._202.0099)

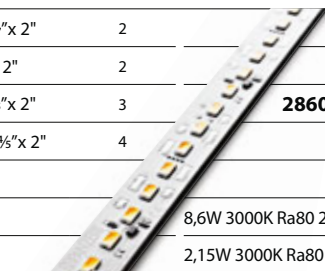

Electric options Solo con componenti remotizzati Only with remote components	page 518
Dimming	522-523
Technical information	526
Wiring diagram 1	526

BRONX

PROFILE	CODICE / CODE	L MM	L INCHES	MM	INCHES	NR. ADVISED	
Schermo monouso + policarbonato incluso Disposable screen + polycarbonate included	<input type="checkbox"/> XG247_..._050.0099	510	20"	515 x 50	20 3/8" x 2"	2	 2860lm/m
	XG247_..._100.0099	1010	40"	1015 x 50	20" x 2"	2	
	XG247_..._200.0099	2010	79 1/8"	2015 x 50	79 3/8" x 2"	3	
	XG247_..._300.0099	3010	118 1/2"	3015 x 50	118 1/8" x 2"	4	
LED MODULE	XM005.050.0110	500	19 3/8"	 62,5 mm			8,6W 3000K Ra80 24V 64 LED 1430lm
	XM005.012.0110	125	5"				2,15W 3000K Ra80 24V 16 LED 357lm

CODICI COLORI DISPONIBILI / COLOUR CODES AVAILABLE

01 Bianco White	02 Nero Black
---------------------------	-------------------------



XM24701.302.0099
XM24702.302.0099

Giunzione piana 90° trimless / Level junction 90° trimless

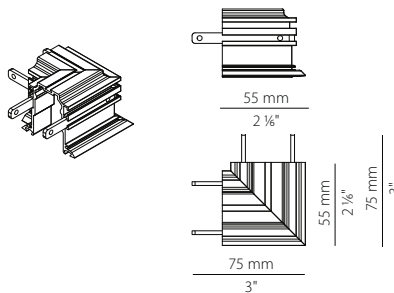

XM24700.301.0099

Kit giunzione lineare / Linear junction kit



XM24701.202.0099

XM24702.202.0099

Coppia di elementi terminali con viti / Pair of end segments with screws



XM24700.201.0099

Coppia staffe di fissaggio per cartongesso / Pair of brackets for false ceiling installation

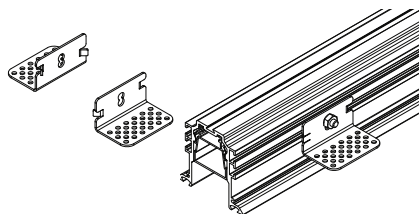

XM2033/34/32/31-S

Cavi di alimentazione / Power cables





BROOKLYN ROUND
XG231 / XG232

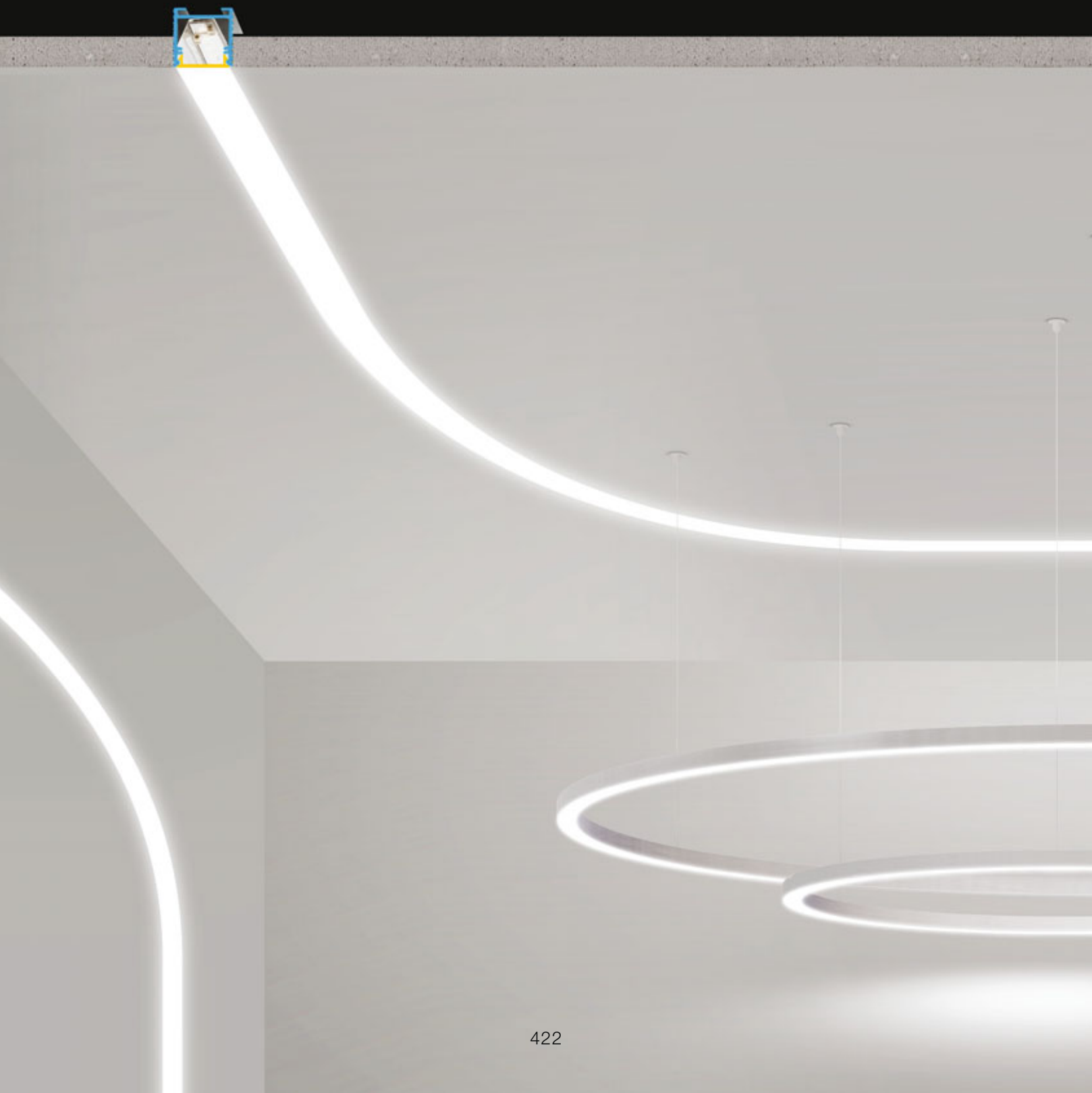



BROOKLYN ROUND

Made in Italy

Sistema modulare in alluminio estruso sottoposto a curvatura con raggio 500mm e 1000mm disponibile in versione incasso a scomparsa, per creare anelli o composizioni miste di linee e curve su soffitto o parete. Sorgente luminosa composta da modulo LED a luce diretta e alimentazione remota. Finitura con vernice poliacrilica in bianco e finitura laterale del profilo a coste. Schermo in policarbonato opale estruso e curvato. Ideale per uffici, hall, zone living, grandi spazi.

Modular system in extruded curved aluminum with 500mm and 1000mm radius. Available in trimless recessed version, offering the possibility to create rings or mixed compositions of lines and curves. Light source made of LED module with direct light and remote power supply. Polyacrylic white painted and ribbed lateral finish. Curved extruded opal polycarbonate diffuser. Ideal for offices, hall, living areas, and large areas.



BROOKLYN ROUND

XG231/XG232 TRIMLESS PROFILE



(XG231/232+XM003.100.0110 or XM003.200.0110+XM231/32-TR)

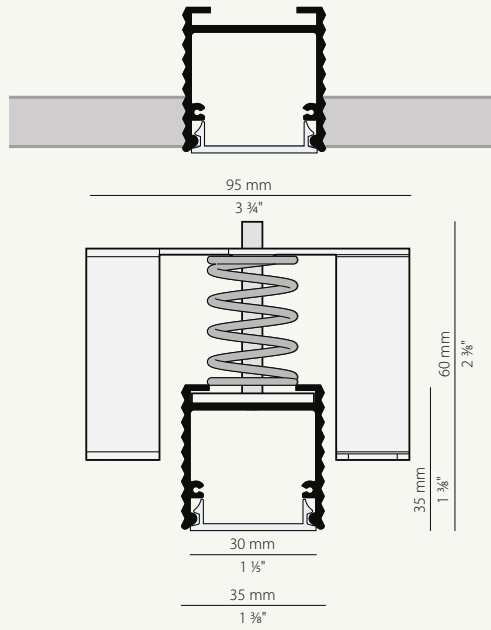

Electric options
Solo con componenti remotizzati
Only with remote components page 518

Dimming 522-523

Technical information 526

Wiring diagram 1 526

BROOKLYN ROUND

LED CE IP40 IP20 IK08 850°

	CODICE / CODE	DEGREES	Ø MM	H MM	Ø INCHES	H INCHES	MM	INCHES	NR.	INCL.
TRIMLESS PROFILE	<input type="radio"/> XG23101.360.0099	360°	1000	35	39 3/8"	1 3/8"	ext. 1005 / int. 926	ext. 39 3/8" / int. 36 1/2"	4	
Protezione monouso per l'installazione, inclusa	<input type="radio"/> XG23101.180.0099	180°	1000	35	39 3/8"	1 3/8"	ext. 1005 / int. 926	ext. 39 3/8" / int. 36 1/2"	3	
Disposable protection for installation included	<input type="radio"/> XG23101.090.0099	90°	1000	35	39 3/8"	1 3/8"	ext. 1005 / int. 926	ext. 39 3/8" / int. 36 1/2"	2	
	<input type="radio"/> XG23201.360.0099	360°	1950	35	76 5/8"	1 3/8"	ext. 1955 / int. 1876	ext. 77" / int. 74"	8	
	<input type="radio"/> XG23201.180.0099	180°	1950	35	76 5/8"	1 3/8"	ext. 1955 / int. 1876	ext. 77" / int. 74"	4	
	<input type="radio"/> XG23201.090.0099	90°	1950	35	76 5/8"	1 3/8"	ext. 1955 / int. 1876	ext. 77" / int. 74"	3	
	<input type="radio"/> XG23201.045.0099	45°	1950	35	76 5/8"	1 3/8"	ext. 1955 / int. 1876	ext. 77" / int. 74"	2	
							LED			
CURVED LED MODULE	XM003.100.0110						6,6W 3000K Ra80 24V 21 LED 807lm			
	XM003.200.0110						6,6W 3000K Ra80 24V 21 LED 807lm			

DIFFUSORI / DIFFUSER

DIFFUSORE OPALE
OPAL DIFFUSER

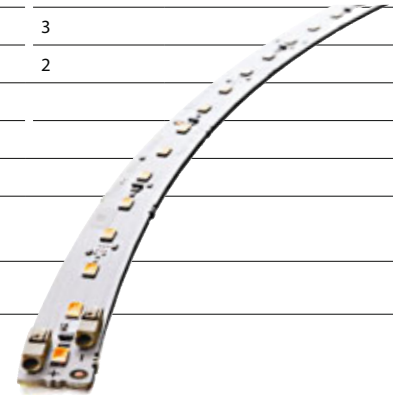

Per composizioni miste di XG2033 e XG231/232 utilizzare solamente moduli LED XM001.050.0110 e XM001.012.0110 senza riflettore per le parti diritte. Oppure, in alternativa, utilizzare solamente strip roll XM1ROW SNAKE/5MT senza riflettore per le parti diritte.

For mix composition made of XG2033 and XG231/232 use only module LED XM001.050.0110 and XM001.012.0110 without reflector for the straight parts or, alternatively, use only strip roll XM1ROW SNAKE/5MT without reflector for the straight parts.

XM231/32-U

Giunzione lineare per moduli rotondi
Linear junction



XM231/32-TR

Coppia di elementi terminali con viti
Pair of end segments with screws

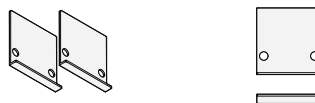

XM231/32-UD

Elemento di unione per diffusore
Diffuser junction



XM2033/34/32/31-S

Cavi di alimentazione
Power cables



LED/DRIVER MATRIX XG231/232

CODICE / CODE	LED MODULE	DRIVER	DRIVER DIM
XG23101.360.0099	8 x XM003.100.0110	1x XM60/24E	1x XM60/24 DIM
XG23101.180.0099	4 x XM003.100.0110	1x XM30/24E	1x XM35/24 DIM
XG23101.090.0099	2 x XM003.100.0110	1x XM30/24E	1x XM35/24 DIM
XG23201.360.0099	16x XM003.200.0110	1x XM150/24E	1x XM150/24 DIM
XG23201.180.0099	8 x XM003.200.0110	1x XM60/24E	1x XM60/24 DIM
XG23201.090.0099	4 x XM003.200.0110	1x XM30/24E	1x XM35/24 DIM
XG23201.045.0099	2 x XM003.200.0110	1x XM30/24E	1x XM35/24 DIM

Disponibili anche rolla LED a 1 row snake vedi pagina 519 electric options.

Matrice di compatibilità LED Profile Matrix pagina 488

Also available LED roll 1 row snake see page 519 electric options.

LED Profile Matrix page 488

STRIP ROLL 1 ROW SNAKE

Per alimentatori vedi pagina 522 electric options
For power supplies see on page 522 electric options

Fotometrie e Classi Energetiche disponibili www.panzeri.it
Photometric data and Energy Label available at www.panzeri.it





BROOKLYN

Made in Italy

Sistema modulare LED in alluminio estruso verniciato bianco sezionabile, da incasso a scomparsa totale (trimless), o con bordo (trim) oppure da parete/soffitto o a sospensione per applicazioni in verticale o orizzontale per cartongesso/laterizio. Per versioni trimless in dotazione doppi diffusori: il primo monouso per rasatura, stuccatura e verniciatura, il secondo definitivo in policarbonato opale o microprismato. Per una corretta e facile installazione nel cartongesso sono disponibili farfalle micro regolabili opzionali, applicabili ogni 400mm ca. Moduli LED multipli da 500mm frazionabili ogni 125mm 3000K 24V. Moduli LED da 125mm 3000K 2,1W 24V, completi di 2 cavetti per collegamento. Predisporre, se necessari, eventuali appendimenti.

Modular LED system in white painted extruded aluminium, dividable, and fully recessed trimless wall for vertical or horizontal use in drywall/concrete. Trim version or wall/ceiling or suspension are also available. Trimless versions include two diffusers: the first disposable for shaving, plastering and painting, the second definitive opal or microprismatic polycarbonate. For a quick and easy installation in drywall, micro adjustable wings nut optional are available, applicable every 400mm approx. Multiple LED modules (500mm long) divisible every 125mm. 3000K 24V. Modules (125mm long) 3000K 24V, complete with 2 connection cables. Prepare, if necessary, any hangings to support the system.



BROOKLYN

XG2033 TRIMLESS PROFILE

BROOKLYN TRIM

XG2034 TRIM PROFILE

BROOKLYN OUT

XP2033 CEILING SUSPENSION



(XG2033-TRACK+XM001.050.0110 or XM004.050.0110+XM2033-T)



(XG2034-TRACK+XM001.050.0110 or XM004.050.0110+XM2034-T)



(XP2033-TRACK+XM001.050.0110 or XM004.050.0110+XM2033-T1)

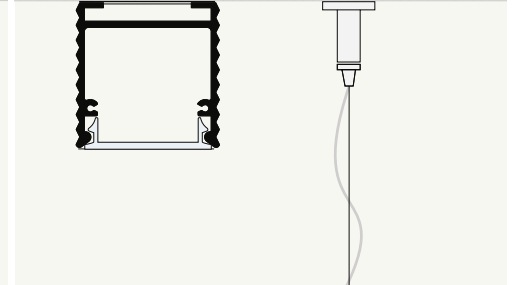
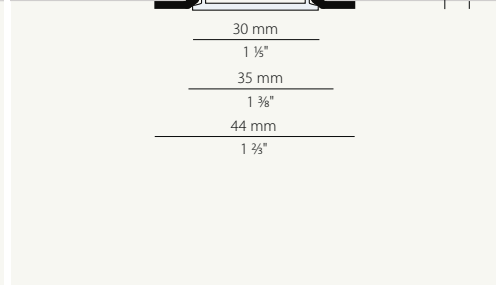
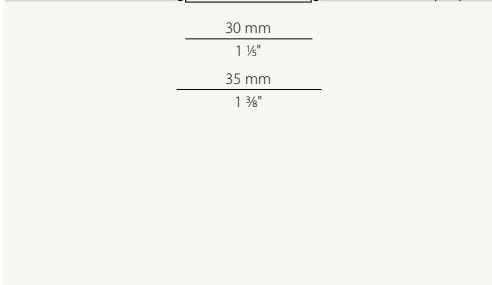
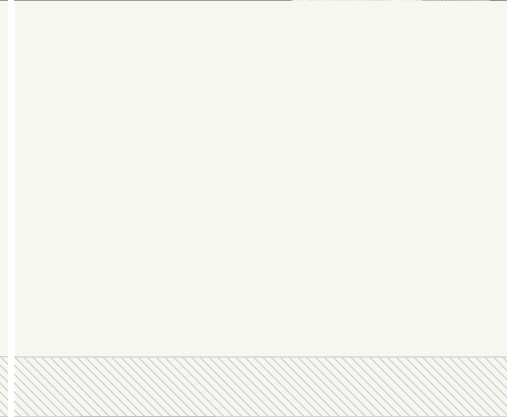
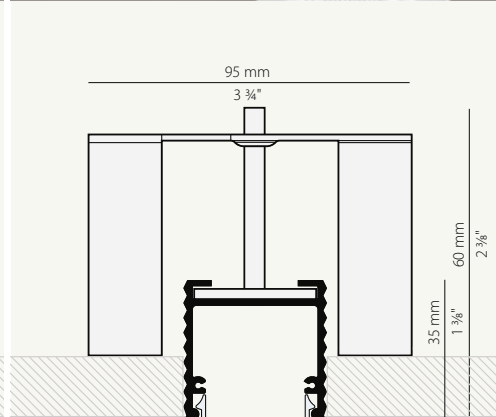
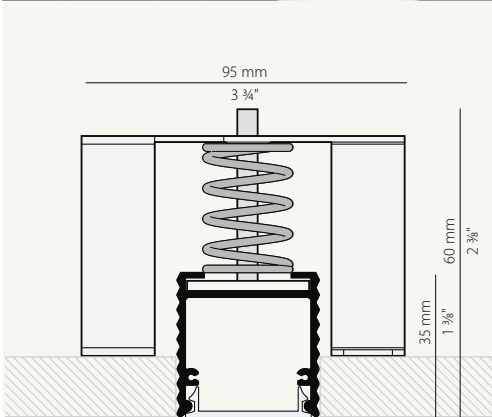

Electric options Solo con componenti remotizzati Only with remote components	page 518
Dimming	522-523
Technical information	526
Wiring diagram 1	526

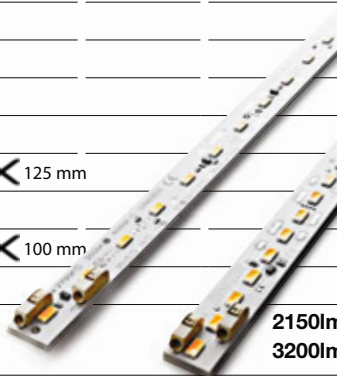

	CODICE / CODE	L MM	L INCHES	MM	INCHES	NR. ADVISED	
TRIMLESS PROFILE	XG2033-50 TRACK	510	20"	515 x 40	20 x 1 3/8"	2	
Diffusore monouso+policarb. opale incl.	XG2033-100 TRACK	1010	40"	1015 x 40	40 x 1 3/8"	2	
Disposable diffuser+opal polycarbonate incl.	XG2033-200 TRACK	2010	79 1/8"	2015 x 40	79 1/8" x 1 3/8"	3	
	XG2033-300 TRACK	3010	118 1/2"	3015 x 40	118 1/2" x 1 3/8"	4	
TRIM PROFILE	XG2034-50 TRACK	510	20"	515 x 40	20 x 1 3/8"	2	
Diffusore monouso+policarb. opale incl.	XG2034-100 TRACK	1010	40"	1015 x 40	40 x 1 3/8"	2	
Disposable diffuser+opal polycarbonate incl.	XG2034-200 TRACK	2010	79 1/8"	2015 x 40	79 1/8" x 1 3/8"	3	
	XG2034-300 TRACK	3010	118 1/2"	3015 x 40	118 1/2" x 1 3/8"	4	
CEILING / SUSPENSION	XP2033-50 TRACK	525	20 3/8"				
Diffusore monouso+policarb. opale incl.	XP2033-100 TRACK	1025	40 3/8"				
Disposable diffuser+opal polycarbonate incl.	XP2033-200 TRACK	2025	79 7/8"				
	XP2033-300 TRACK	3025	119 1/8"				
LED MODULE	XM001.050.0110	500	19 1/2"	125 mm			LED 8,5W 3000K Ra80 24V 28 LED 1075lm
	XM001.012.0110	125	5"				2,1W 3000K Ra80 24V 7 LED 268lm
	XM004.050.0110	500	19 1/2"	100 mm			12W 3000K Ra80 24V 35 LED 1600lm
	XM004.010.0110	10	5"				2,4W 3000K Ra80 24V 7 LED 320lm

**2150lm/mt
3200lm/mt**
DIFFUSORI / DIFFUSER
DIFFUSORE OPALE **PR • MICROPRISMATO** bordi laterali opali (da aggiungere al codice)
OPAL DIFFUSER **MICROPRISMATIC** opal side edges (to be added to code)

Per composizioni miste di XG2033 e XG231/232 utilizzare solamente moduli LED XM001.050.0110 e XM001.012.0110 senza riflettore per le parti diritte. Oppure, in alternativa, utilizzare solamente strip roll XM1ROW SNAKE/5MT senza riflettore per le parti diritte.

For mix composition made of XG2033 and XG231/232 use only module LED XM001.050.0110 and XM001.012.0110 without reflector for the straight parts or, alternatively, use only strip roll XM1ROW SNAKE/5MT without reflector for the straight parts.

Raccordi con angoli speciali su richiesta.
Lo schermo e il profilo possono essere tagliati dall'installatore durante il montaggio oppure su richiesta servizio taglio.

Fittings with special angles on request.
The screen and the extruded aluminium can be cut during installation or on request cutting service.

XM2033-U90

Giunzione piana 90° trimless
Level junction 90° trimless

XM2033-U90 XP

Giunzione piana 90° trimless
Level junction 90° trimless

XM2034-U90

Giunzione piana 90° trim
Level junction 90° trim

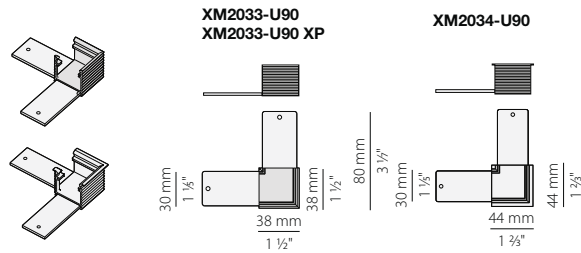

XM2033-UT

Giunzione a T trimless
T junction trimless

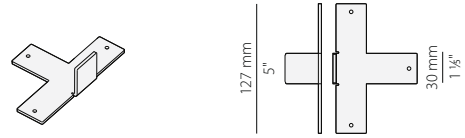

XM2033-X

Giunzione a X trimless
X junction trimless

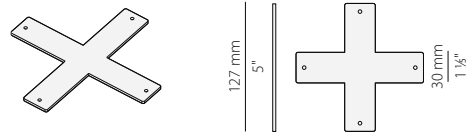

XM2033/34-ANG

Accessorio per angolo verticale 120x120 mm
Junction for vertical angle 120x120 mm



XM2033-U45

Giunzione piana per tagli a 45°
Level junction for 45° cuts



XM2033/34-U

Giunzione lineare
Linear junction



XM2033/34/45/46-600S

Diffusore in policarbonato opale mm 6000 / Opal polycarbonate diffuser mm 6000

Only for project not for stock

XM2033/34/45/46-900S

Diffusore in policarbonato opale mm 9000 / Opal polycarbonate diffuser mm 9000

Only for project not for stock

XM2033/34/45/46-1200S

Diffusore in policarbonato opale mm 12000 / Opal polycarbonate diffuser mm 12000

Only for project not for stock

XM2033/34/45/46-600S PR

Diffusore in policarbonato microprismato mm 6000 / Microprismatic polycarbonate diffuser mm 6000

Only for project not for stock

XM2033/34/45/46-900S PR

Diffusore in policarbonato microprismato mm 9000 / Microprismatic polycarbonate diffuser mm 9000

Only for project not for stock

XM2033/34/45/46-1200S PR

Diffusore in policarbonato microprismato mm 12000 / Microprismatic polycarbonate diffuser mm 12000

Only for project not for stock

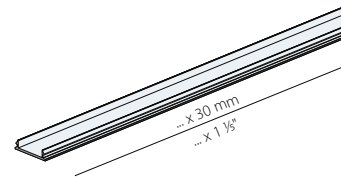

XM2033/34-WHI

Riflettore bianco mm 1000 sezionabile
1000 mm dividable white reflector



XM2033-T

Coppia di elementi terminali con viti trimless
Pair of end segments with screws trimless



XM2034-T

Coppia di elementi terminali con viti trim
Pair of end segments with screws trim



XM2033-T1

Coppia di elementi terminali con viti (XP2033)
Pair of end segments with screws (XP2033)



XM2033-F

Farfalla di fissaggio versione trimless per cartongesso regolabile (posizionabile ogni 400 mm circa)
Wing nut trimless version for adjustable drywall (can be placed every 400 mm approx)

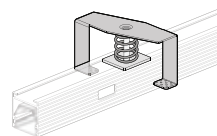

XM2034-F

Farfalla di fissaggio versione trim per cartongesso regolabile (posizionabile ogni 400 mm circa)
Wing nut trim version for adjustable drywall (can be placed every 400 mm approx)

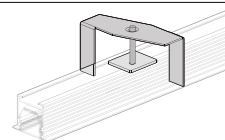

XM2033/34/38/39P

Piastrina per eventuale appendimento
Plate for eventual hanging



XM2033/34-L

Coppia piastrine fissaggio su laterizio
Plates couple for brickfixing



XM2033-T150W

Kit di alimentazione soffitto/parete: rosone bianco + driver 150W
Power kit for ceiling/wall: white canopy + driver 150W

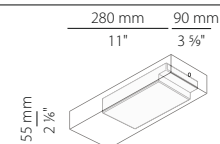

XM2033-ST150W

Kit di alimentazione sospensione: rosone bianco + driver 150 W + cavo lunghezza cm 220
Power supply kit for suspension: white canopy + driver 150W + cable cm 220 length

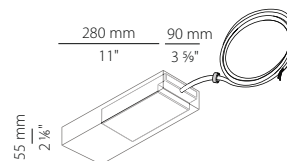

XM2033-T150W DIM

Kit di alimentazione soffitto/parete: rosone bianco + driver 150W DIM
Power kit for ceiling/wall: white canopy + driver 150W DIM

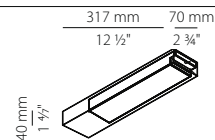

XM2033-ST150W DIM

Kit di alimentazione sospensione: rosone bianco + driver 150 W DIM + cavo lunghezza cm 220
Power supply kit for suspension: white canopy + driver 150W DIM + cable cm 220 length

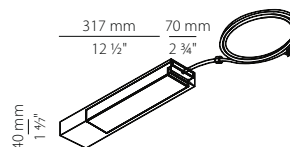

XM-KIT-S

Singolo elemento di sospensione
Single suspension kit



XM2033/34/32/31-S

Cavi di alimentazione
Power cables



XM2033-A

Coppia copri luce adesivo lineare (per angoli e giunzioni XP2033)
Pair of linear adhesive light cover (per angle and junction XP2033)

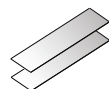

XM231/32-P

Distanziale per installazione a parete/plafone
Spacer for wall/ceiling installation



Disponibili anche rolle LED. Vedi pagina 519 electric options.
Matrice di compatibilità LED Profile Matrix pagina 488
Also available LED rolls see page 519 electric options.
LED Profile Matrix page 488

STRIP ROLL 1 ROW
STRIP ROLL 1 ROW HE/N
STRIP ROLL 1 ROW HD
STRIP ROLL 1 ROW HF
STRIP ROLL 1 ROW SNAKE

BROOKLYN SPOT

ORIENTABILE / ADJUSTABLE

Spot nero o bianco orientabile per profilo Brooklyn completo di driver, predisposto con cablaggio passante 24V per alimentare il resto del sistema Brooklyn. Da non usarsi in partenza o alla fine. Disponibile anche la versione singola a plafone bianca o nera.

Adjustable black or white spot for Brooklyn profile driver included, spot supplied with 24V through wiring to power the entire the Brooklyn system. Never to be used at the beginning or at the end. Single ceiling version also available

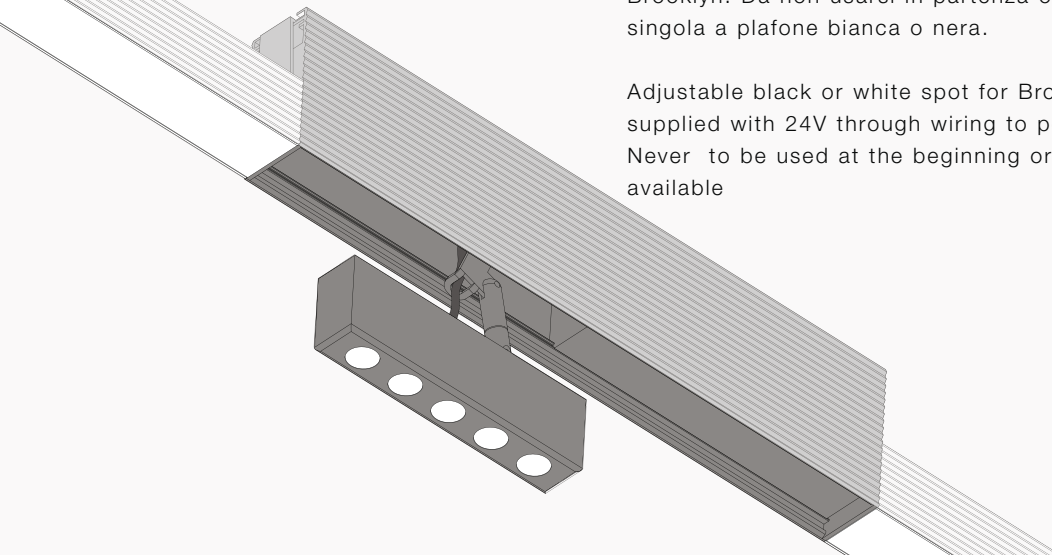

BROOKLYN SPOT		Enzo Panzeri 2015	Registered design		LED	CE IP20
	CODICE / CODE	L. MM	L. INCHES	MM	INCHES	LED
SPOT ORIENTABILE ADJUSTABLE SPOT	XM2033-__SPOT	350	13 7/8"	355 x 40	14 x 1 3/8"	Potenza assorbita apparecchio / Luminaire power consumption 10W Flusso luminoso apparecchio / Luminaire luminous flux 698lm 3000K Ra80 41° 220-240V
SPOT A SOFFITTO ORIENTABILE ADJUSTABLE CEILING SPOT	P2033-__SPOT	350	13 7/8"			Potenza assorbita apparecchio / Luminaire power consumption 10W Flusso luminoso apparecchio / Luminaire luminous flux 698lm 3000K Ra80 41° 220-240V

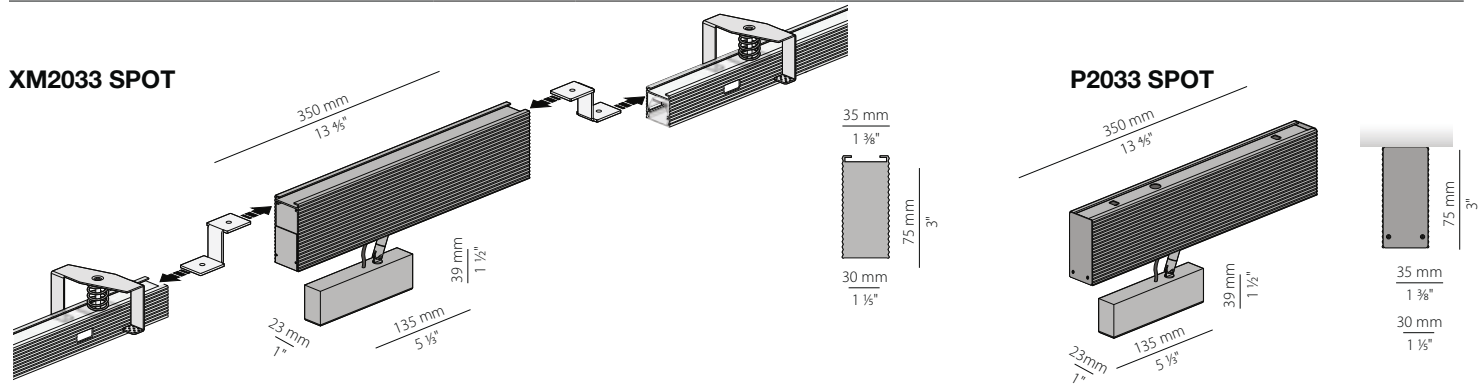

CODICI COLORI DISPONIBILI / COLOUR CODES AVAILABLE

- 01** Bianco / White
- 02** Nero / Black

Fotometrie e Classi Energetiche disponibili www.panzeri.it
Photometric data and Energy Label available at www.panzeri.it



BROOKLYN

XG2033

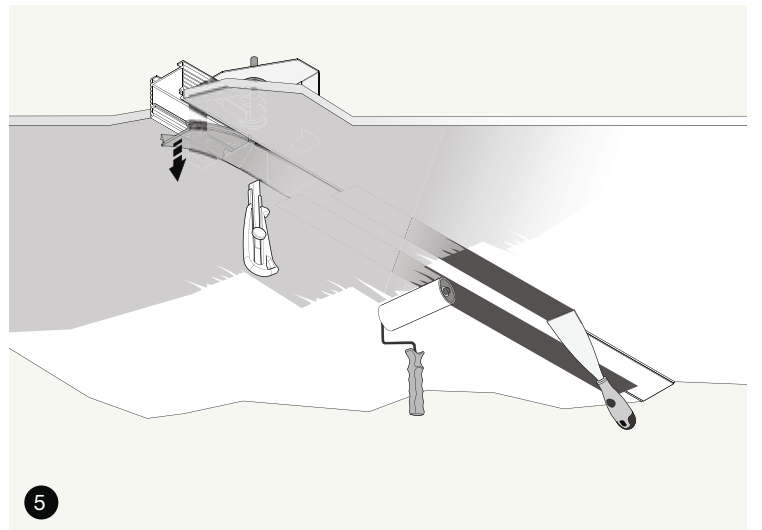
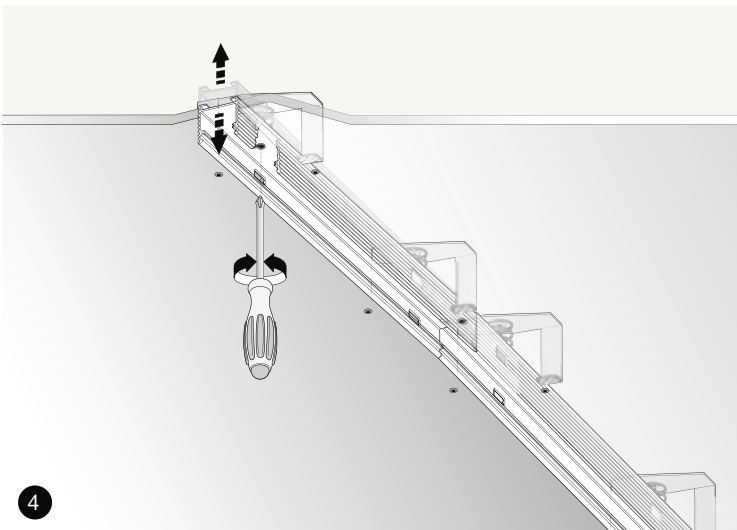
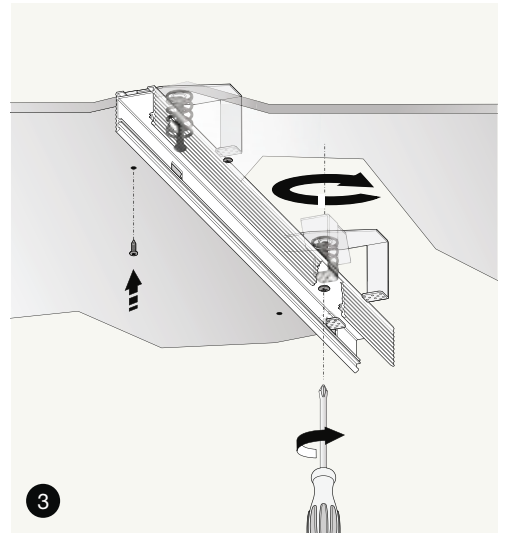
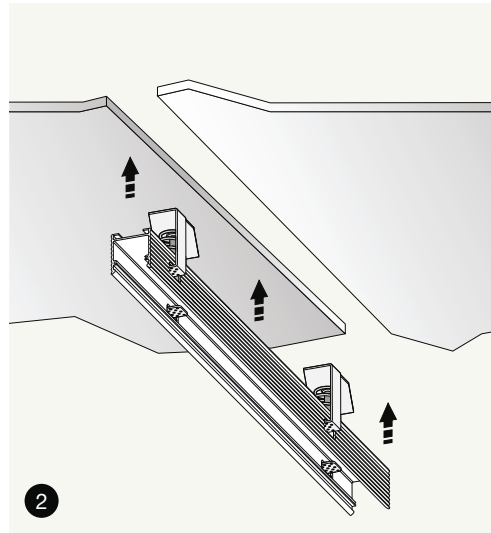
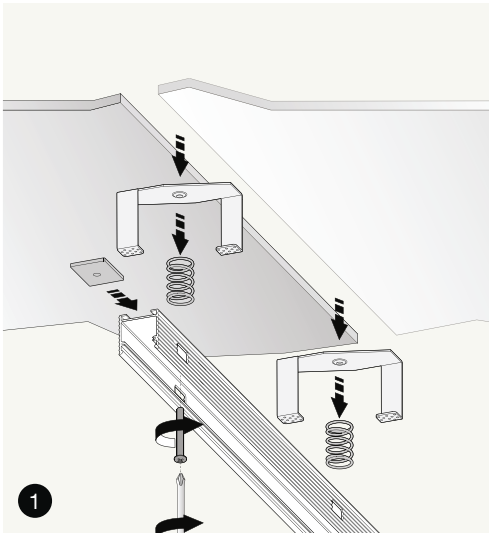
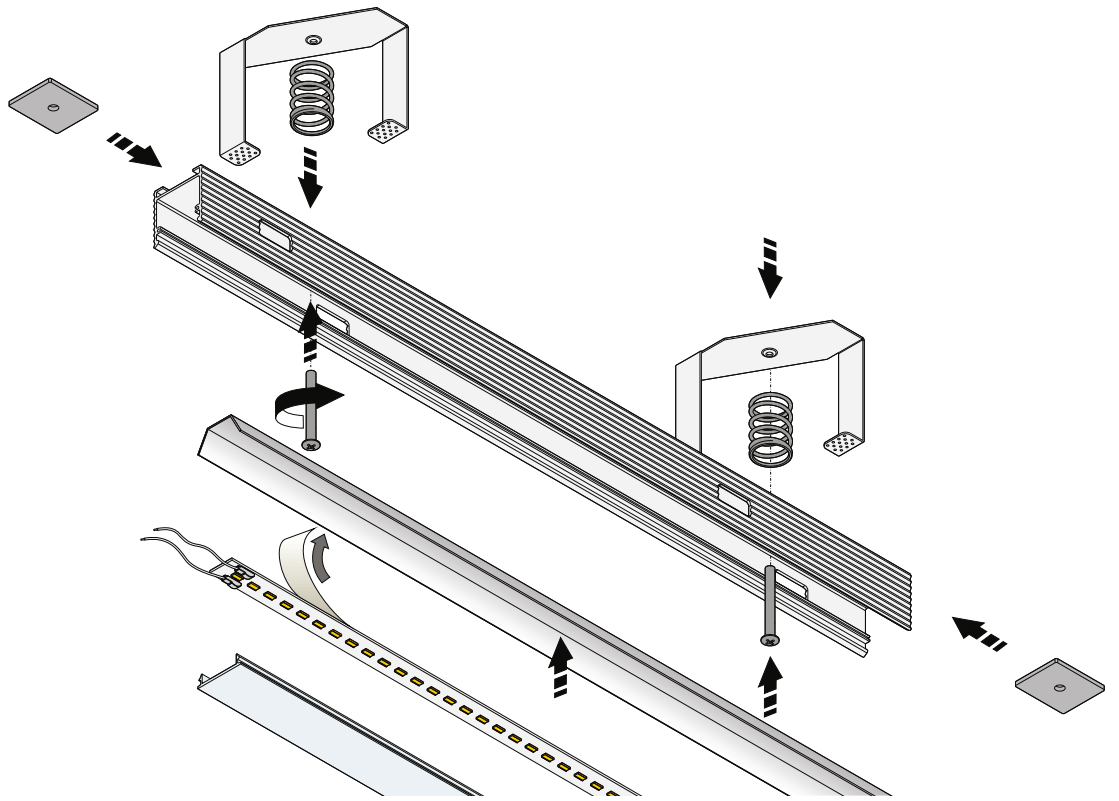

Attenzione. Rispettare la polarità. Collegamento in parallelo.
Attention. Observe the polarity. Install in parallel.

XM2033/34-U
Giunzione lineare
Linear junction

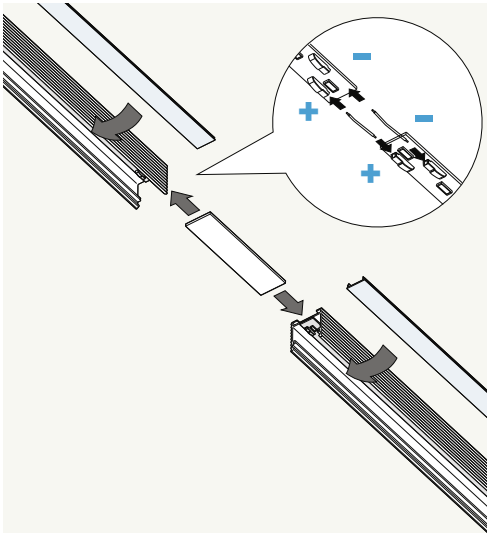

XM2033/34-ANG
Giunzione 90° parete-soffitto
90° Wall to ceiling junction

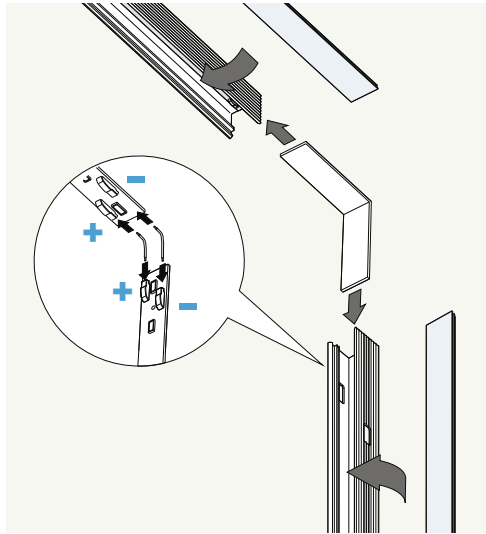

XM2033-UT
Giunzione T trimless
T junction trimless

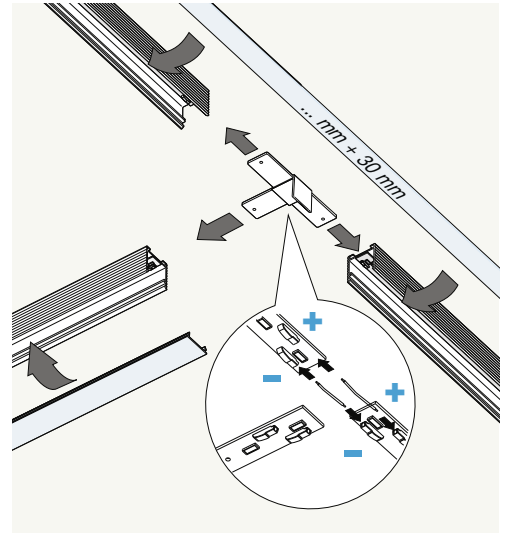

XM2033-U90
Giunzione 90° parete-parete / soffitto-soffitto trimless
90° Wall to wall / ceiling to ceiling junction trimless

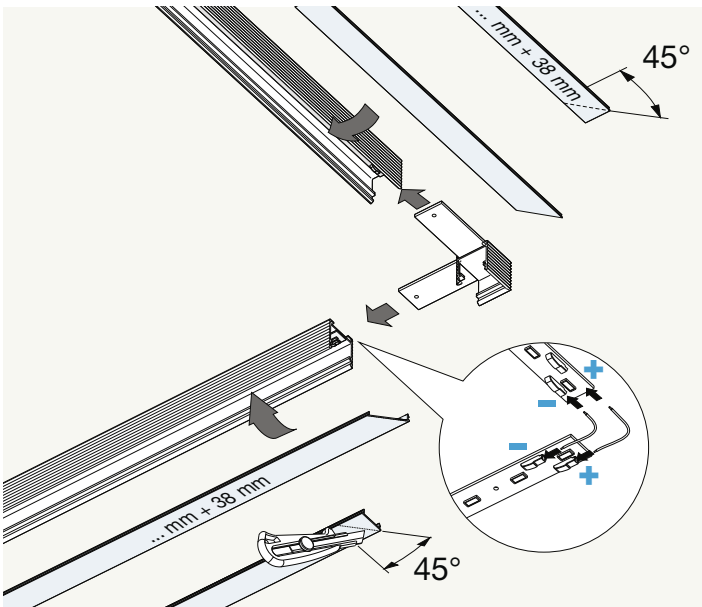

XM2033-X
Giunzione X trimless
X junction trimless

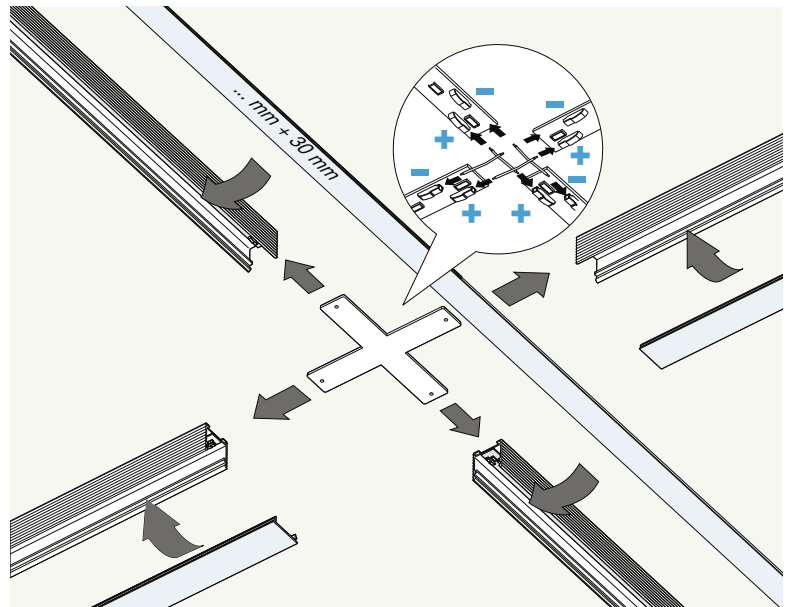

BROOKLYN TRIM

XG2034

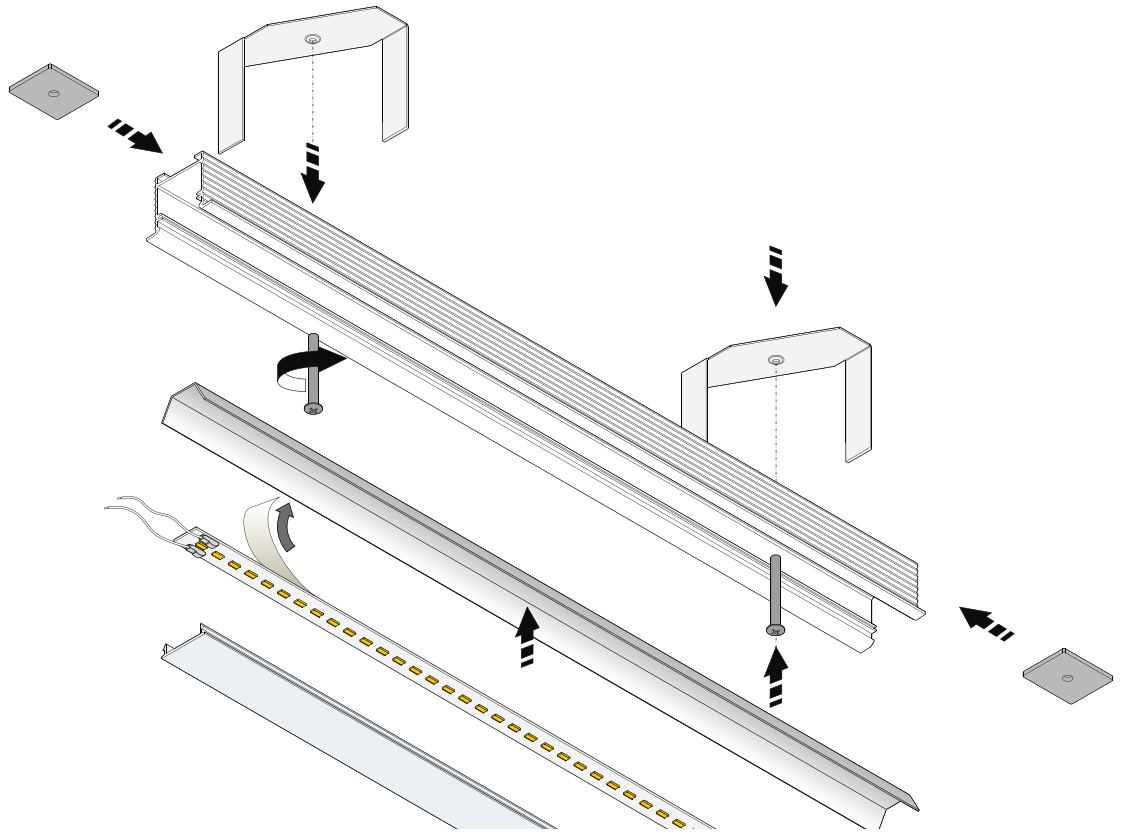

XM2033/34-U
Giunzione lineare
Linear junction

XM2033/34-ANG
Giunzione 90° parete-soffitto
90° Wall to ceiling junction

XM2034-U90
Giunzione 90° parete-parete / soffitto-soffitto trim
90° Wall to wall / ceiling to ceiling junction trim

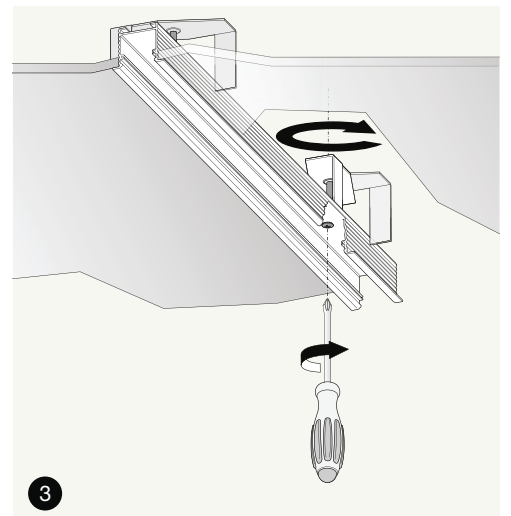
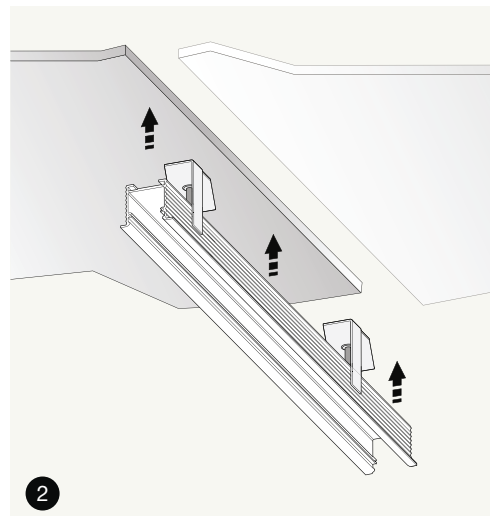
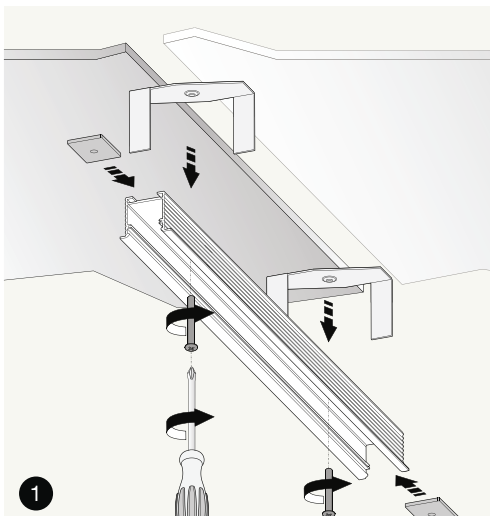
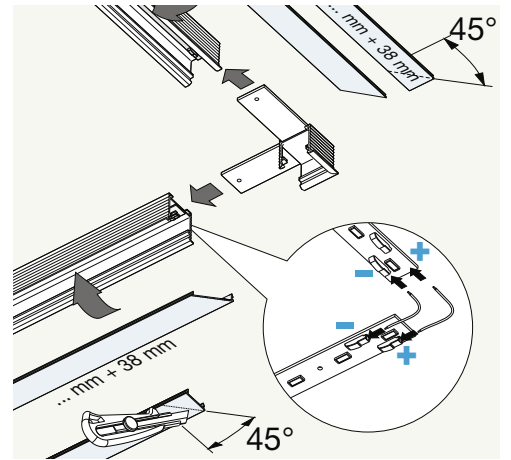
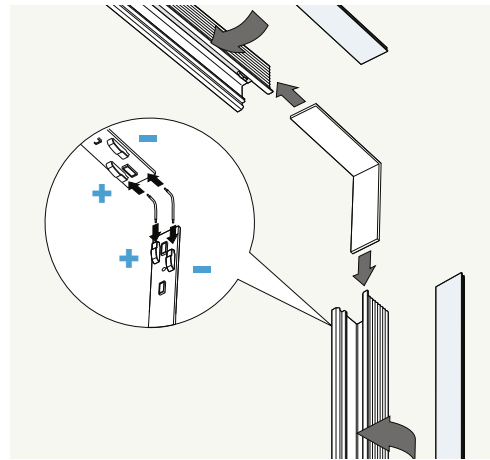
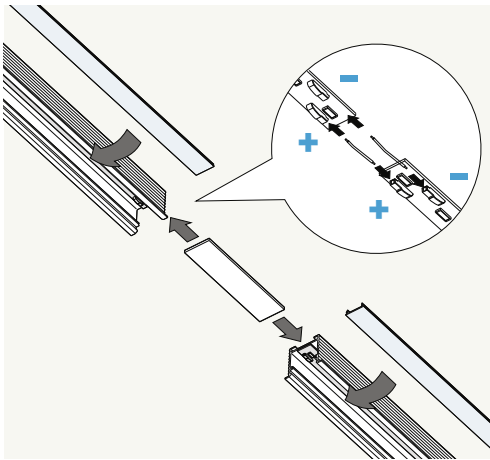

BROOKLYN OUT

XP2033

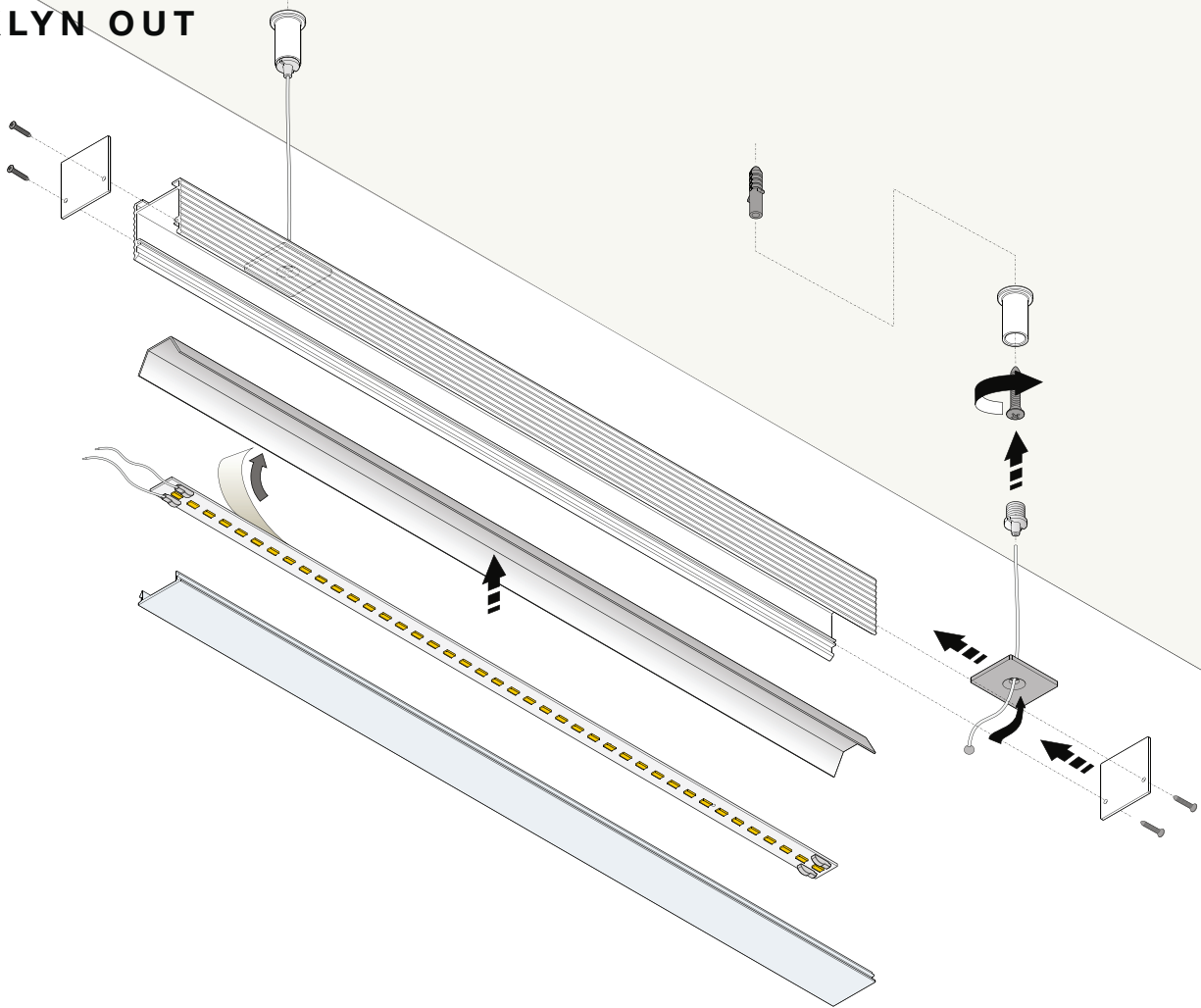

XM2033/34-U

Giunzione lineare
Linear junction

• XM2033-A

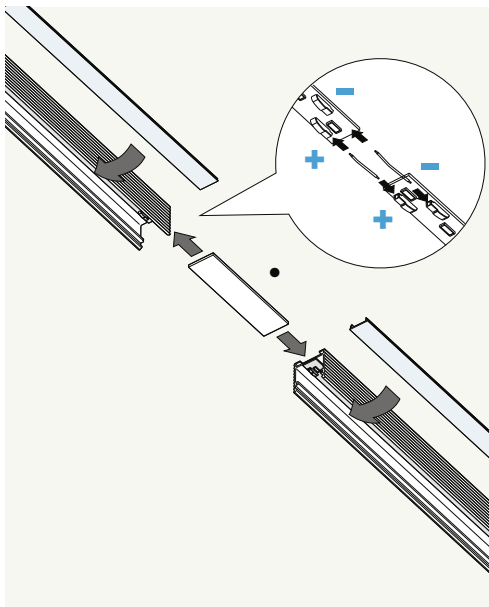

XM2033-U90 XP

Giunzione 90° parete-parete / soffitto-soffitto
90° Wall to wall / ceiling to ceiling junction

• XM2033-A

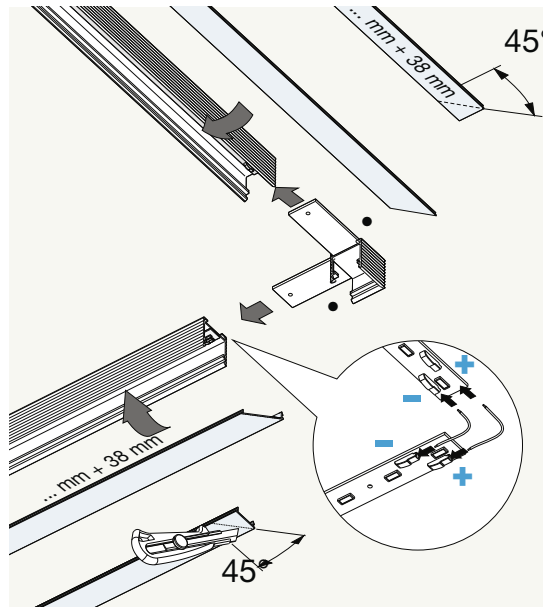

Attenzione. Rispettare la polarità.
Collegamento in parallelo.
Attention. Observe the polarity.
Install in parallel.

TRIBECA

Profilo con bordo (trim) in alluminio estruso sezionabile, 2000mm completo di diffusore in policarbonato, da incasso per applicazioni in verticale o orizzontale.

Cuttable profile with border (trim) in extruded aluminium 2000mm complete of polycarbonate diffuser, recessed for vertical or horizontal use.



TRIBECA

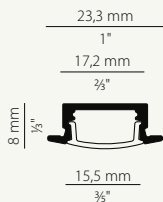

XG2047TRACK 

(XG2047-TRACK+XM1ROW HD/5MT+XM2047-T)



Electric options	page 518
Dimming	522-523
Technical information	526
Wiring diagram 2	526

  IP40 

	CODICE / CODE	L MM	L INCHES	 MM	 INCHES
TRIM PROFILE	XG2047TRACK	2000	78 4/5"	2000 x 17	78 4/5" x 3/8"

XM2047-T

Coppia di elementi terminali trim
Pair of end segments trim



XM1ROW HD/5MT

STRIP ROLL 1 ROW 5 MT 3000K Ra80 24V

 42mm

5 x 168 led/mt - 5 x 17 W/mt

5 x 1964lm/mt

XM1ROW HF/5MT

STRIP ROLL 1 ROW 5 MT 3000K Ra80 24V

 42mm

5 x 168 led/mt - 5 x 10 W/mt

5 x 1200lm/mt

Per alimentatori vedi pagina 522 electric options
For power supplies see on page 522 electric options

Fotometrie e Classi Energetiche disponibili www.panzeri.it
Photometric data and Energy Label available at www.panzeri.it

BROADWAY

Profilo da parete/soffitto, in alluminio estruso sezionabile 2000mm, completo di diffusore in policarbonato.

Wall/ceiling cuttable profile in extruded aluminium, 2000mm supplied with polycarbonate diffuser.



BROADWAY

XP2048TRACK □

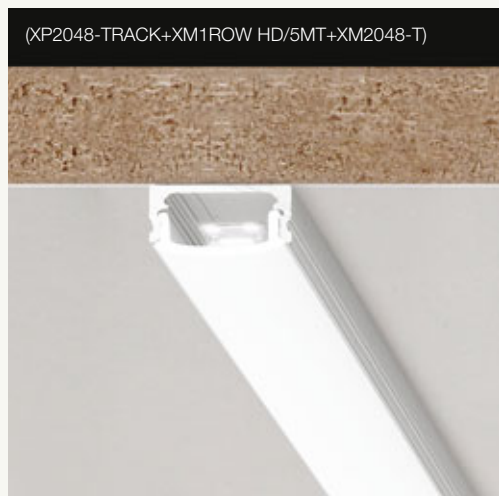

(XP2048-TRACK+XM1ROW HD/5MT+XM2048-T)

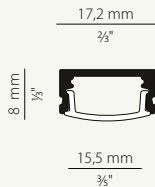

Electric options	page 518
Dimming	522-523
Technical information	526
Wiring diagram 2	526



	CODICE / CODE	L MM	L INCHES
PROFILE	XP2048 TRACK	2000	78 1/2"

XM2048-T

Coppia di elementi terminali
Pair of end segments

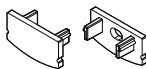

XM2048-C

Coppia clip di fissaggio
Pair fixing clip

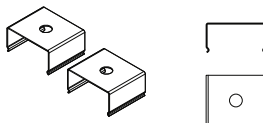

XM1ROW HD/5MT

STRIP ROLL 1 ROW 5 MT 3000K Ra80 24V

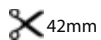

5 x 168 led/mt - 5 x 17 W/mt
5 x 1964lm/mt



XM1ROW HF/5MT

STRIP ROLL 1 ROW 5 MT 3000K Ra80 24V

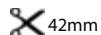

5 x 168 led/mt - 5 x 10 W/mt
5 x 1200lm/mt



Per alimentatori vedi pagina 522 electric options
For power supplies see on page 522 electric options

Fotometrie e Classi Energetiche disponibili www.panzeri.it
Photometric data and Energy Label available at www.panzeri.it

NOLITA

Made in Italy

Sistema modulare LED, in alluminio estruso verniciato bianco disponibile in varie misure, da incasso a scomparsa totale (trimless), o con bordo (trim) oppure da parete/soffitto o a sospensione per applicazioni in verticale o orizzontale per cartongesso/laterizio. Per una corretta e facile installazione nel cartongesso sono disponibili farfalle micro regolabili opzionali. Per versioni trimless in dotazione doppi schermi: il primo monouso per rasatura, stuccatura e verniciatura, il secondo definitivo in policarbonato opale o microprismato. Completo di driver e LED con flussi luminosi superiori ad una lampada fluorescente HO T5. Su richiesta le versioni con emergenza integrata. Predisporre, se necessari, eventuali appendimenti.

Modular LED system, painted white, in extruded aluminum available in various sizes, trimless, for vertical or horizontal installation in drywall/brick. For a correct and easy installation in false ceiling adjustable micro wing nuts are available (optional). Trim version or wall/ceiling or suspension are also available. Trimless versions include two screens: the first disposable for shaving, plastering and painting, the second definitive in opal or microprismatic polycarbonate. Complete with drivers and LED with luminous flux of more than a T5 HO fluorescent bulb. On request version with integrated emergency. Prepare any suspensions, if necessary.



**NOLITA
NOLITA ECO**

(XG2038-...+XM2038-T)

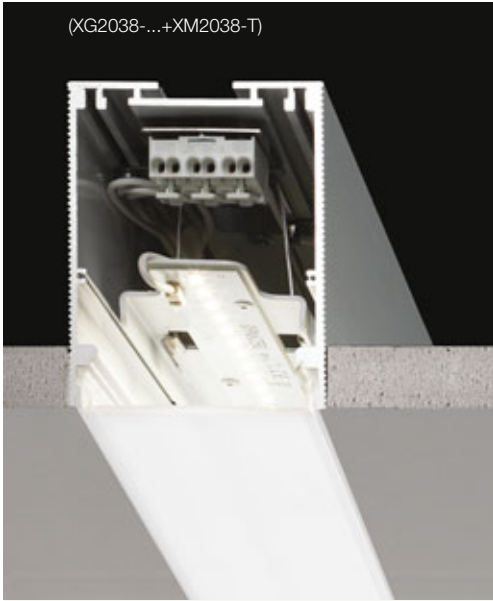

**NOLITA TRIM
NOLITA TRIM ECO**

(XG2039-...+XM2039-T)

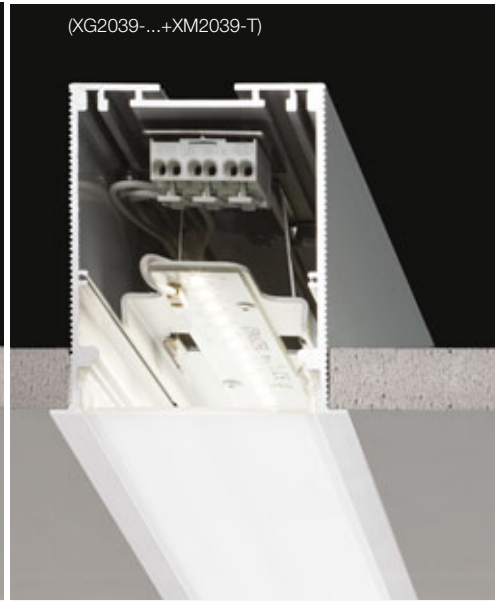

**NOLITA OUT
NOLITA OUT ECO**

(XP2038-...+XM2038-T1)



XG2038 TRIMLESS PROFILE

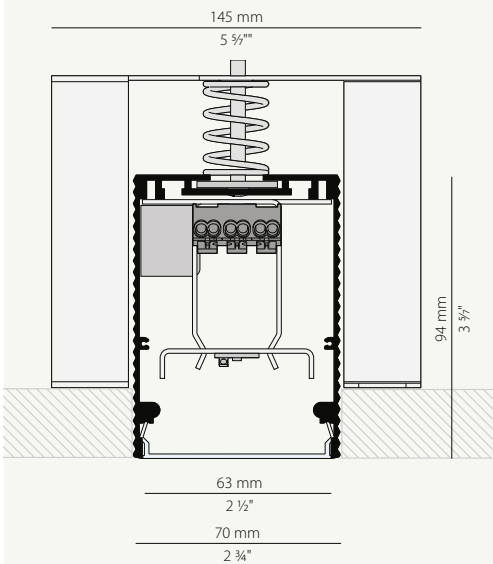

XG2039 TRIM PROFILE

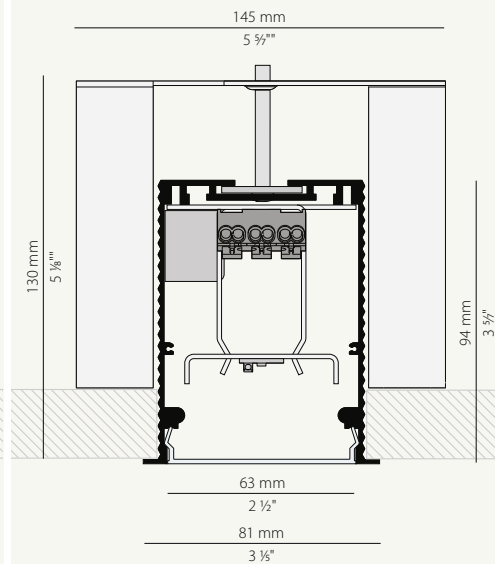

XP2038 CEILING
SUSPENSION

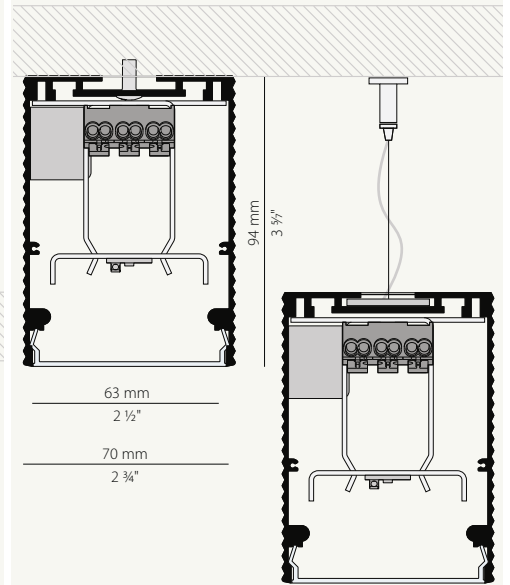

NOLITA

TRIMLESS PROFILE	CODICE / CODE	L MM	L INCHES	MM	INCHES	NR. ADVISED	LED
No Led no driver + disposable screen	XG2038-60 TRACK	591	23 3/4"	596 x 75	23 1/2 x 3"	2	
	XG2038-60 TRACK JOLLY	591	23 3/4"	596 x 75	23 1/2 x 3"		 100 mm
Led + driver + schermo monouso Led + driver + disposable screen	XG2038-60 ECO	591	23 3/4"	596 x 75	23 1/2 x 3"	2	Potenza assorbita apparecchio / Luminaire power consumption 16W Flusso luminoso apparecchio / Luminaire luminous flux 864lm OPAL / 1018lm PR 3000K Ra80 220-240V
	XG2038-60 ECO DALI	591	23 3/4"	596 x 75	23 1/2 x 3"	2	Potenza assorbita apparecchio / Luminaire power consumption 16W Flusso luminoso apparecchio / Luminaire luminous flux 864lm OPAL / 1018lm PR 3000K Ra80 220-240V DALI / PUSH DIM
	XG2038-60	591	23 3/4"	596 x 75	23 1/2 x 3"	2	Potenza assorbita apparecchio / Luminaire power consumption 24,5W Flusso luminoso apparecchio / Luminaire luminous flux 1416lm OPAL / 1668lm PR 3000K Ra80 220-240V
	XG2038-60 DALI	591	23 3/4"	596 x 75	23 1/2 x 3"	2	Potenza assorbita apparecchio / Luminaire power consumption 24,5W Flusso luminoso apparecchio / Luminaire luminous flux 1416lm OPAL / 1668lm PR 3000K Ra80 220-240V DALI / PUSH DIM
Opal diffuser	XM2038/39-60S	591 x 63	23 3/4" x 2 1/2"				
Microprismatic	XM2038/39-60S PR	591 x 63	23 3/4" x 2 1/2"				
No Led no driver + disposable screen	XG2038-90 TRACK	891	35 1/8"	896 x 75	35 3/8" x 3"	2	
	XG2038-90 ECO	891	35 1/8"	896 x 75	35 3/8" x 3"	2	Potenza assorbita apparecchio / Luminaire power consumption 22,5W Flusso luminoso apparecchio / Luminaire luminous flux 1297lm OPAL / 1527lm PR 3000K Ra80 220-240V
Led + driver + schermo monouso Led + driver + disposable screen	XG2038-90 ECO DALI	891	35 1/8"	896 x 75	35 3/8" x 3"	2	Potenza assorbita apparecchio / Luminaire power consumption 22,5W Flusso luminoso apparecchio / Luminaire luminous flux 1297lm OPAL / 1527lm PR 3000K Ra80 220-240V DALI / PUSH DIM
	XG2038-90 ECO EM	891	35 1/8"	896 x 75	35 3/8" x 3"	2	Potenza assorbita apparecchio / Luminaire power consumption 22,5W Flusso luminoso apparecchio / Luminaire luminous flux 1297lm OPAL / 1527lm PR 3000K Ra80 220-240V 1H/12H EMERGENCY
	XG2038-90	891	35 1/8"	896 x 75	35 3/8" x 3"	2	Potenza assorbita apparecchio / Luminaire power consumption 35W Flusso luminoso apparecchio / Luminaire luminous flux 2125lm OPAL / 2502lm PR 3000K Ra80 220-240V
	XG2038-90 DALI	891	35 1/8"	896 x 75	35 3/8" x 3"	2	Potenza assorbita apparecchio / Luminaire power consumption 35W Flusso luminoso apparecchio / Luminaire luminous flux 2125lm OPAL / 2502lm PR 3000K Ra80 220-240V DALI / PUSH DIM
	XG2038-90 EM	891	35 1/8"	896 x 75	35 3/8" x 3"	2	Potenza assorbita apparecchio / Luminaire power consumption 35W Flusso luminoso apparecchio / Luminaire luminous flux 2125lm OPAL / 2502lm PR 3000K Ra80 220-240V 1H/12H EMERGENCY
Opal diffuser	XM2038/39-90S	891 x 63	35 1/8" x 2 1/2"				
Microprismatic	XM2038/39-90S PR	891 x 63	35 1/8" x 2 1/2"				
No Led no driver + disposable screen	XG2038-120 TRACK	1191	47"	1196 x 75	47 1/8" x 3"	2	
	XG2038-120 ECO	1191	47"	1196 x 75	47 1/8" x 3"	2	Potenza assorbita apparecchio / Luminaire power consumption 29W Flusso luminoso apparecchio / Luminaire luminous flux 1729lm OPAL / 2037lm PR 3000K Ra80 220-240V
Led + driver + schermo monouso Led + driver + disposable screen	XG2038-120 ECO DALI	1191	47"	1196 x 75	47 1/8" x 3"	2	Potenza assorbita apparecchio / Luminaire power consumption 29W Flusso luminoso apparecchio / Luminaire luminous flux 1729lm OPAL / 2037lm PR 3000K Ra80 220-240V DALI / PUSH DIM
	XG2038-120 ECO EM	1191	47"	1196 x 75	47 1/8" x 3"	2	Potenza assorbita apparecchio / Luminaire power consumption 29W Flusso luminoso apparecchio / Luminaire luminous flux 1729lm OPAL / 2037lm PR 3000K Ra80 220-240V 1H/12H EMERGENCY
	XG2038-120	1191	47"	1196 x 75	47 1/8" x 3"	2	Potenza assorbita apparecchio / Luminaire power consumption 46W Flusso luminoso apparecchio / Luminaire luminous flux 2833lm OPAL / 3336lm PR 3000K Ra80 220-240V
	XG2038-120 DALI	1191	47"	1196 x 75	47 1/8" x 3"	2	Potenza assorbita apparecchio / Luminaire power consumption 46W Flusso luminoso apparecchio / Luminaire luminous flux 2833lm OPAL / 3336lm PR 3000K Ra80 220-240V DALI / PUSH DIM
	XG2038-120 EM	1191	47"	1196 x 75	47 1/8" x 3"	2	Potenza assorbita apparecchio / Luminaire power consumption 46W Flusso luminoso apparecchio / Luminaire luminous flux 2833lm OPAL / 3336lm PR 3000K Ra80 220-240V 1H/12H EMERGENCY
Opal diffuser	XM2038/39-120S	1191 x 63	47" x 2 1/2"				
Microprismatic	XM2038/39-120S PR	1191 x 63	47" x 2 1/2"				

DIFFUSORI / DIFFUSER

DIFFUSORE OPALE **PR** • MICROPISMATO bordi laterali opale (da aggiungere al codice)
OPAL DIFFUSER MICROPISMATIC opal side edges (to be added to code)



Il diffusore ed il **PROFILO TRACK** possono essere tagliati dall'installatore durante il montaggio, oppure su richiesta servizio taglio
The diffuser and the extruded aluminium **TRACK** can be cut during installation or on request cutting service

• UGR < 19 in funzione delle condizioni di installazione
UGR < 19 depending on installation conditions

Fotometrie e Classi Energetiche disponibili www.panzeri.it
Photometric data and Energy Label available at www.panzeri.it

NOLITA

TRIMLESS PROFILE	CODICE / CODE	L MM	L INCHES	MM	INCHES	NR. ADVISED	LED
No Led no driver + disposable screen	XG2038-150 TRACK	1491	58 ¾"	1496 x 75	59" x 3"	2	
Led + driver + schermo monouso Led + driver + disposable screen	XG2038-150 ECO	1491	58 ¾"	1496 x 75	59" x 3"	2	Potenza assorbita apparecchio / Luminaire power consumption 35,5W Flusso luminoso apparecchio / Luminaire luminous flux 2162lm OPAL / 2546lm PR 3000K Ra80 220-240V
	XG2038-150 ECO DALI	1491	58 ¾"	1496 x 75	59" x 3"	2	Potenza assorbita apparecchio / Luminaire power consumption 35,5W Flusso luminoso apparecchio / Luminaire luminous flux 2162lm OPAL / 2546lm PR 3000K Ra80 220-240V DALI / PUSH DIM
	XG2038-150 ECO EM	1491	58 ¾"	1496 x 75	59" x 3"	2	Potenza assorbita apparecchio / Luminaire power consumption 35,5W Flusso luminoso apparecchio / Luminaire luminous flux 2162lm OPAL / 2546lm PR 3000K Ra80 220-240V 1H/12H EMERGENCY
	XG2038-150	1491	58 ¾"	1496 x 75	59" x 3"	2	Potenza assorbita apparecchio / Luminaire power consumption 57W Flusso luminoso apparecchio / Luminaire luminous flux 3541lm OPAL / 4171lm PR 3000K Ra80 220-240V
	XG2038-150 DALI	1491	58 ¾"	1496 x 75	59" x 3"	2	Potenza assorbita apparecchio / Luminaire power consumption 57W Flusso luminoso apparecchio / Luminaire luminous flux 3541lm OPAL / 4171lm PR 3000K Ra80 220-240V DALI / PUSH DIM
Opal diffuser	XM2038/39-150S	1491 x 63	58 ¾" x 2 ½"				
Microprismatic	XM2038/39-150S PR	1491 x 63	58 ¾" x 2 ½"				
No Led no driver+ disposable screen	XG2038-240 TRACK	2382	93 ½"	2387 x 75	94" x 3"	2	
Opal diffuser	XM2038/39-260S	2600 x 63	102 ¼" x 2 ½"				
	XM2038/39-380S	3800 x 63	149 ⅝" x 2 ½"				
Microprismatic diffuser	XM2038/39-260S PR	2600 x 63	102 ¼" x 2 ½"				
	XM2038/39-380S PR	3800 x 63	149 ⅝" x 2 ½"				

DIFFUSORI / DIFFUSER

DIFFUSORE OPALE **PR** • MICROPRISMATO bordi laterali opale (da aggiungere al codice)
OPAL DIFFUSER MICROPRISMATIC opal side edges (to be added to code)



Il diffusore ed il **PROFILO TRACK** possono essere tagliati dall'installatore durante il montaggio, oppure su richiesta servizio taglio
The diffuser and the extruded aluminium **TRACK** can be cut during installation or on request cutting service



NOLITA TRIM

TRIM PROFILE	CODICE / CODE	L MM	L INCHES	MM	INCHES	NR. ADVISED	LED
No Led no driver	XG2039-60 TRACK	591	23 3/8"	596 x 75	23 1/2 x 3"	2	
	XG2039-60 TRACK JOLLY	591	23 3/8"	596 x 75	23 1/2 x 3"		 100 mm
Led + driver	XG2039-60 ECO	591	23 3/8"	596 x 75	23 1/2 x 3"	2	Potenza assorbita apparecchio / Luminaire power consumption 16W Flusso luminoso apparecchio / Luminaire luminous flux 864lm OPAL / 1018lm PR 3000K Ra80 220-240V
	XG2039-60 ECO DALI	591	23 3/8"	596 x 75	23 1/2 x 3"	2	Potenza assorbita apparecchio / Luminaire power consumption 16W Flusso luminoso apparecchio / Luminaire luminous flux 864lm OPAL / 1018lm PR 3000K Ra80 220-240V DALI / PUSH DIM
	XG2039-60	591	23 3/8"	596 x 75	23 1/2 x 3"	2	Potenza assorbita apparecchio / Luminaire power consumption 24,5W Flusso luminoso apparecchio / Luminaire luminous flux 1416lm OPAL / 1668lm PR 3000K Ra80 220-240V
	XG2039-60 DALI	591	23 3/8"	596 x 75	23 1/2 x 3"	2	Potenza assorbita apparecchio / Luminaire power consumption 24,5W Flusso luminoso apparecchio / Luminaire luminous flux 1416lm OPAL / 1668lm PR 3000K Ra80 220-240V DALI / PUSH DIM
Opal diffuser	XM2038/39-60S	591 x 63	23 3/8" x 2 1/2"				
Microprismatic	XM2038/39-60S PR	591 x 63	23 3/8" x 2 1/2"				
No Led no driver	XG2039-90 TRACK	891	35 1/8"	896 x 75	35 3/8" x 3"	2	
Led + driver	XG2039-90 ECO	891	35 1/8"	896 x 75	35 3/8" x 3"	2	Potenza assorbita apparecchio / Luminaire power consumption 22,5W Flusso luminoso apparecchio / Luminaire luminous flux 1297lm OPAL / 1527lm PR 3000K Ra80 220-240V
	XG2039-90 ECO DALI	891	35 1/8"	896 x 75	35 3/8" x 3"	2	Potenza assorbita apparecchio / Luminaire power consumption 22,5W Flusso luminoso apparecchio / Luminaire luminous flux 1297lm OPAL / 1527lm PR 3000K Ra80 220-240V DALI / PUSH DIM
	XG2039-90 ECO EM	891	35 1/8"	896 x 75	35 3/8" x 3"	2	Potenza assorbita apparecchio / Luminaire power consumption 22,5W Flusso luminoso apparecchio / Luminaire luminous flux 1297lm OPAL / 1527lm PR 3000K Ra80 220-240V 1H/12H EMERGENCY
	XG2039-90	891	35 1/8"	896 x 75	35 3/8" x 3"	2	Potenza assorbita apparecchio / Luminaire power consumption 35W Flusso luminoso apparecchio / Luminaire luminous flux 2125lm OPAL / 2502lm PR 3000K Ra80 220-240V
	XG2039-90 DALI	891	35 1/8"	896 x 75	35 3/8" x 3"	2	Potenza assorbita apparecchio / Luminaire power consumption 35W Flusso luminoso apparecchio / Luminaire luminous flux 2125lm OPAL / 2502lm PR 3000K Ra80 220-240V DALI / PUSH DIM
	XG2039-90 EM	891	35 1/8"	896 x 75	35 3/8" x 3"	2	Potenza assorbita apparecchio / Luminaire power consumption 35W Flusso luminoso apparecchio / Luminaire luminous flux 2125lm OPAL / 2502lm PR 3000K Ra80 220-240V 1H/12H EMERGENCY
Opal diffuser	XM2038/39-90S	891 x 63	35 1/8" x 2 1/2"				
Microprismatic	XM2038/39-90S PR	891 x 63	35 1/8" x 2 1/2"				
No Led no driver	XG2039-120 TRACK	1191	47"	1196 x 75	47 1/8" x 3"	2	
Led + driver	XG2039-120 ECO	1191	47"	1196 x 75	47 1/8" x 3"	2	Potenza assorbita apparecchio / Luminaire power consumption 29W Flusso luminoso apparecchio / Luminaire luminous flux 1729lm OPAL / 2037lm PR 3000K Ra80 220-240V
	XG2039-120 ECO DALI	1191	47"	1196 x 75	47 1/8" x 3"	2	Potenza assorbita apparecchio / Luminaire power consumption 29W Flusso luminoso apparecchio / Luminaire luminous flux 1729lm OPAL / 2037lm PR 3000K Ra80 220-240V DALI / PUSH DIM
	XG2039-120 ECO EM	1191	47"	1196 x 75	47 1/8" x 3"	2	Potenza assorbita apparecchio / Luminaire power consumption 29W Flusso luminoso apparecchio / Luminaire luminous flux 1729lm OPAL / 2037lm PR 3000K Ra80 220-240V 1H/12H EMERGENCY
	XG2039-120	1191	47"	1196 x 75	47 1/8" x 3"	2	Potenza assorbita apparecchio / Luminaire power consumption 46W Flusso luminoso apparecchio / Luminaire luminous flux 2833lm OPAL / 3336lm PR 3000K Ra80 220-240V
	XG2039-120 DALI	1191	47"	1196 x 75	47 1/8" x 3"	2	Potenza assorbita apparecchio / Luminaire power consumption 46W Flusso luminoso apparecchio / Luminaire luminous flux 2833lm OPAL / 3336lm PR 3000K Ra80 220-240V DALI / PUSH DIM
	XG2039-120 EM	1191	47"	1196 x 75	47 1/8" x 3"	2	Potenza assorbita apparecchio / Luminaire power consumption 46W Flusso luminoso apparecchio / Luminaire luminous flux 2833lm OPAL / 3336lm PR 3000K Ra80 220-240V 1H/12H EMERGENCY
Opal diffuser	XM2038/39-120S	1191 x 63	47" x 2 1/2"				
Microprismatic	XM2038/39-120S PR	1191 x 63	47" x 2 1/2"				
No Led no driver	XG2039-150 TRACK	1491	58 3/4"	1496 x 75	59" x 3"	2	
Led + driver	XG2039-150 ECO	1491	58 3/4"	1496 x 75	59" x 3"	2	Potenza assorbita apparecchio / Luminaire power consumption 35,5W Flusso luminoso apparecchio / Luminaire luminous flux 2162lm OPAL / 2546lm PR 3000K Ra80 220-240V
	XG2039-150 ECO DALI	1491	58 3/4"	1496 x 75	59" x 3"	2	Potenza assorbita apparecchio / Luminaire power consumption 35,5W Flusso luminoso apparecchio / Luminaire luminous flux 2162lm OPAL / 2546lm PR 3000K Ra80 220-240V DALI / PUSH DIM

• UGR < 19 in funzione delle condizioni di installazione
UGR < 19 depending on installation conditions

Fotometrie e Classi Energetiche disponibili www.panzeri.it
Photometric data and Energy Label available at www.panzeri.it

NOLITA TRIM

LED CE IP40 IP20 IK08 850°

TRIM PROFILE	CODICE / CODE	L MM	L INCHES	MM	INCHES	NR. ADVISED	LED
	XG2039-150 ECO EM	1491	58 ¾"	1496 x 75	59" x 3"	2	Potenza assorbita apparecchio / Luminaire power consumption 35,5W Flusso luminoso apparecchio / Luminaire luminous flux 2162lm OPAL / 2546lm PR 3000K Ra80 220-240V 1H/12H EMERGENCY
	XG2039-150	1491	58 ¾"	1496 x 75	59" x 3"	2	Potenza assorbita apparecchio / Luminaire power consumption 57W Flusso luminoso apparecchio / Luminaire luminous flux 3541lm OPAL / 4171lm PR 3000K Ra80 220-240V
	XG2039-150 DALI	1491	58 ¾"	1496 x 75	59" x 3"	2	Potenza assorbita apparecchio / Luminaire power consumption 57W Flusso luminoso apparecchio / Luminaire luminous flux 3541lm OPAL / 4171lm PR 3000K Ra80 220-240V DALI / PUSH DIM
Opal diffuser	XM2038/39-150S	1491 x 63	58 ¾" x 2 ½"				
Microprismatic	XM2038/39-150S PR	1491 x 63	58 ¾" x 2 ½"				
No Led no driver	XG2039-240 TRACK	2382	93 ⅞"	2387 x 75	94" x 3"	2	
Opal diffuser	XM2038/39-260S	2600 x 63	102 ⅞" x 2 ½"				
	XM2038/39-380S	3800 x 63	149 ⅞" x 2 ½"				
Microprismatic diffuser	XM2038/39-260S PR	2600 x 63	102 ⅞" x 2 ½"				
	XM2038/39-380S PR	3800 x 63	149 ⅞" x 2 ½"				

DIFFUSORI / DIFFUSER

DIFFUSORE OPALE **PR** • MICROPRISMATO bordi laterali opale (da aggiungere al codice)
OPAL DIFFUSER MICROPRISMATIC opal side edges (to be added to code)



Lo schermo ed il **PROFILO TRACK** possono essere tagliati dall'installatore durante il montaggio, oppure su richiesta servizio taglio
The screen and the extruded aluminium **TRACK** can be cut during installation or on request cutting service



Assolombarda Monza, Italia

• UGR < 19 in funzione delle condizioni di installazione
UGR < 19 depending on installation conditions

Fotometrie e Classi Energetiche disponibili www.panzeri.it
Photometric data and Energy Label available at www.panzeri.it



NOLITA OUT

LED CE IP40 IP20 IK08 850°

PROFILE	CODICE / CODE	L MM	L INCHES	LED
Led + driver	XP2038-60 ECO	591	23 3/8"	Potenza assorbita apparecchio / Luminaire power consumption 16W Flusso luminoso apparecchio / Luminaire luminous flux 864lm OPAL / 1018lm PR 3000K Ra80 220-240V
	XP2038-60 ECO DALI	591	23 3/8"	Potenza assorbita apparecchio / Luminaire power consumption 16W Flusso luminoso apparecchio / Luminaire luminous flux 864lm OPAL / 1018lm PR 3000K Ra80 220-240V DALI / PUSH DIM
	XP2038-60	591	23 3/8"	Potenza assorbita apparecchio / Luminaire power consumption 24,5W Flusso luminoso apparecchio / Luminaire luminous flux 1416lm OPAL / 1668lm PR 3000K Ra80 220-240V
	XP2038-60 DALI	591	23 3/8"	Potenza assorbita apparecchio / Luminaire power consumption 24,5W Flusso luminoso apparecchio / Luminaire luminous flux 1416lm OPAL / 1668lm PR 3000K Ra80 220-240V DALI / PUSH DIM
Opal diffuser	XM2038/39-60S	591 x 63	23 3/8" x 2 1/2"	
Microprismatic	XM2038/39-60S PR	591 x 63	23 3/8" x 2 1/2"	
Led + driver	XP2038-90 ECO	891	35 1/8"	Potenza assorbita apparecchio / Luminaire power consumption 22,5W Flusso luminoso apparecchio / Luminaire luminous flux 1297lm OPAL / 1527lm PR 3000K Ra80 220-240V
	XP2038-90 ECO DALI	891	35 1/8"	Potenza assorbita apparecchio / Luminaire power consumption 22,5W Flusso luminoso apparecchio / Luminaire luminous flux 1297lm OPAL / 1527lm PR 3000K Ra80 220-240V DALI / PUSH DIM
	XP2038-90	891	35 1/8"	Potenza assorbita apparecchio / Luminaire power consumption 35W Flusso luminoso apparecchio / Luminaire luminous flux 2125lm OPAL / 2502lm PR 3000K Ra80 220-240V
	XP2038-90 DALI	891	35 1/8"	Potenza assorbita apparecchio / Luminaire power consumption 35W Flusso luminoso apparecchio / Luminaire luminous flux 2125lm OPAL / 2502lm PR 3000K Ra80 220-240V DALI / PUSH DIM
Opal diffuser	XM2038/39-90S	891 x 63	35 1/8" x 2 1/2"	
Microprismatic	XM2038/39-90S PR	891 x 63	35 1/8" x 2 1/2"	
Led + driver	XP2038-120 ECO	1191	47"	Potenza assorbita apparecchio / Luminaire power consumption 29W Flusso luminoso apparecchio / Luminaire luminous flux 1729lm OPAL / 2037lm PR 3000K Ra80 220-240V
	XP2038-120 ECO DALI	1191	47"	Potenza assorbita apparecchio / Luminaire power consumption 29W Flusso luminoso apparecchio / Luminaire luminous flux 1729lm OPAL / 2037lm PR 3000K Ra80 220-240V DALI / PUSH DIM
	XP2038-120	1191	47"	Potenza assorbita apparecchio / Luminaire power consumption 46W Flusso luminoso apparecchio / Luminaire luminous flux 2833lm OPAL / 3336lm PR 3000K Ra80 220-240V
	XP2038-120 DALI	1191	47"	Potenza assorbita apparecchio / Luminaire power consumption 46W Flusso luminoso apparecchio / Luminaire luminous flux 2833lm OPAL / 3336lm PR 3000K Ra80 220-240V DALI / PUSH DIM
Opal diffuser	XM2038/39-120S	1191 x 63	47" x 2 1/2"	
Microprismatic	XM2038/39-120 PR	1191 x 63	47" x 2 1/2"	
Led + driver	XP2038-150 ECO	1491	58 3/4"	Potenza assorbita apparecchio / Luminaire power consumption 35,5W Flusso luminoso apparecchio / Luminaire luminous flux 2162lm OPAL / 2546lm PR 3000K Ra80 220-240V
	XP2038-150 ECO DALI	1491	58 3/4"	Potenza assorbita apparecchio / Luminaire power consumption 35,5W Flusso luminoso apparecchio / Luminaire luminous flux 2162lm OPAL / 2546lm PR 3000K Ra80 220-240V DALI / PUSH DIM
	XP2038-150	1491	58 3/4"	Potenza assorbita apparecchio / Luminaire power consumption 57W Flusso luminoso apparecchio / Luminaire luminous flux 3541lm OPAL / 4171lm PR 3000K Ra80 220-240V
	XP2038-150 DALI	1491	58 3/4"	Potenza assorbita apparecchio / Luminaire power consumption 57W Flusso luminoso apparecchio / Luminaire luminous flux 3541lm OPAL / 4171lm PR 3000K Ra80 220-240V DALI / PUSH DIM
	XM2038/39-150S	1491 x 63	58 3/4" x 2 1/2"	
Opal diffuser	XM2038/39-260S	2600 x 63	102 4/8" x 2 1/2"	
	XM2038/39-380S	3800 x 63	149 5/7" x 2 1/2"	
Microprismatic diffuser	XM2038/39-150S PR	1491 x 63	58 3/4" x 2 1/2"	
	XM2038/39-260S PR	2600 x 63	102 4/8" x 2 1/2"	
	XM2038/39-380S PR	3800 x 63	149 5/7" x 2 1/2"	

DIFFUSORI / DIFFUSER

DIFFUSORE OPALE
OPAL DIFFUSER

PR • MICROPRISMATO bordi laterali opale (da aggiungere al codice)
MICROPRISMATIC opal side edges (to be added to code)



• UGR < 19 in funzione delle condizioni di installazione
UGR < 19 depending on installation conditions

Fotometrie e Classi Energetiche disponibili www.panzeri.it
Photometric data and Energy Label available at www.panzeri.it

XG2038-ANG 60/120 ECO

Potenza assorbita apparecchio/
Luminaire power consumption 16W
Flusso luminoso apparecchio/
Luminaire luminous flux
864lm OPAL / 1018lm PR
3000K Ra80 220-240V

Profilo trimless in alluminio estruso angolo 60/120 verniciato bianco completo di LED e driver +
schermo monouso.
60/120 Corner trimless profile in extruded aluminium painted white with LED and driver +
disposable screen

XG2038-ANG 60/120

Potenza assorbita apparecchio/
Luminaire power consumption 24,5W
Flusso luminoso apparecchio/
Luminaire luminous flux
1416lm OPAL / 1668lm PR
3000K Ra80 220-240V

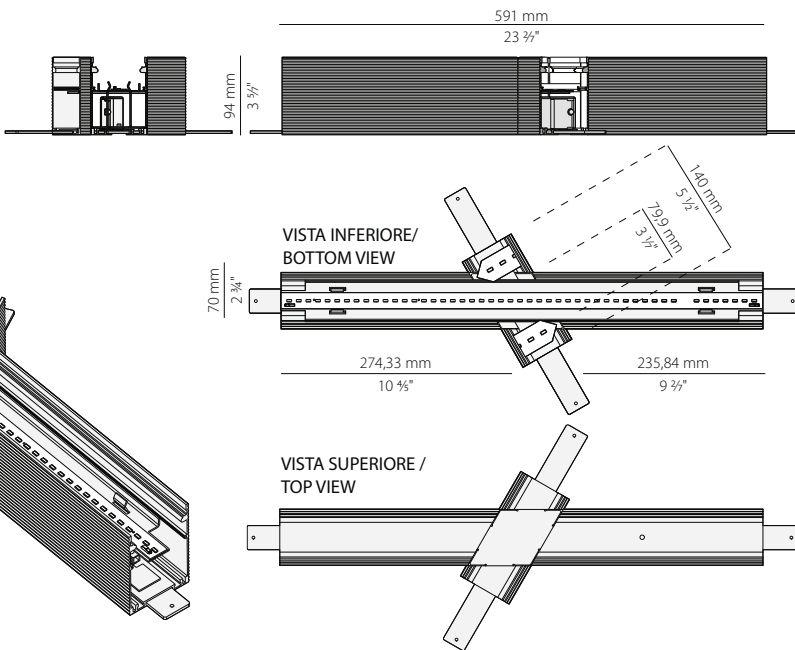
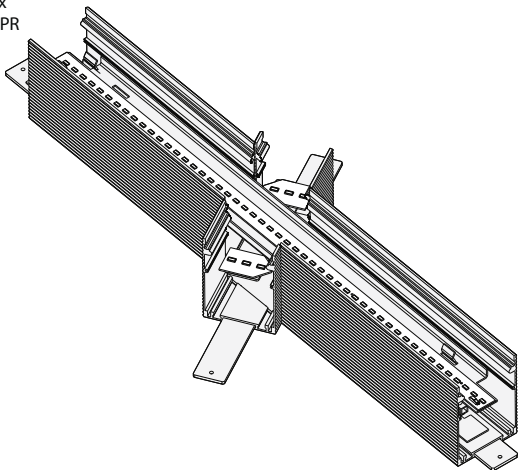

XG2038-ANG 60/120 ECO DALI

Potenza assorbita apparecchio/
Luminaire power consumption 16W
Flusso luminoso apparecchio/
Luminaire luminous flux
864lm OPAL / 1018lm PR
3000K Ra80 220-240V DALI / PUSH DIM

Profilo trimless in alluminio estruso angolo 60/120 verniciato bianco completo di LED e driver
dimmerabile DALI / PUSH DIM + schermo monouso.
60/120 Corner trimless profile in extruded aluminium painted white with LED and driver
dimmerable DALI / PUSH DIM + disposable screen

XG2038-ANG 60/120 DALI

Potenza assorbita apparecchio/
Luminaire power consumption 24,5W
Flusso luminoso apparecchio/
Luminaire luminous flux
1416lm OPAL / 1668lm PR
3000K Ra80 220-240V DALI / PUSH DIM

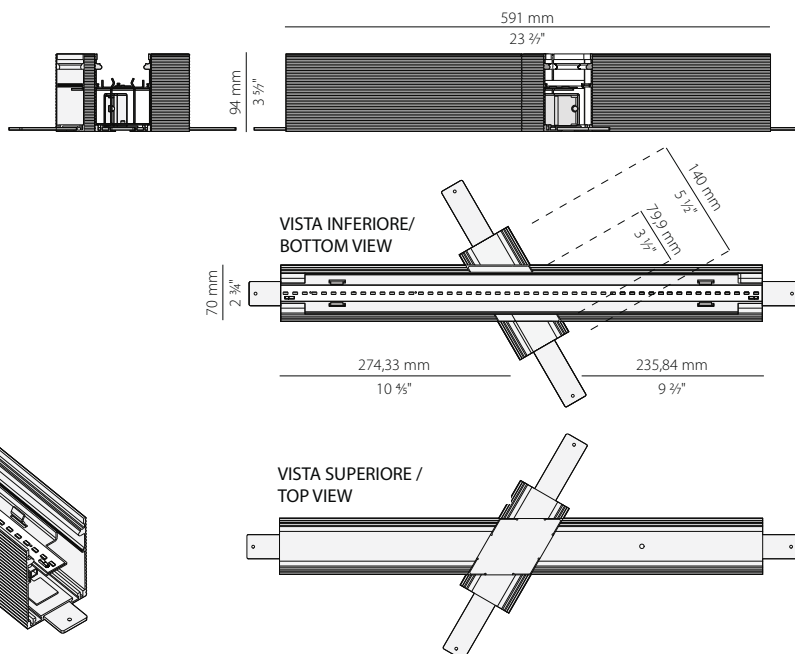
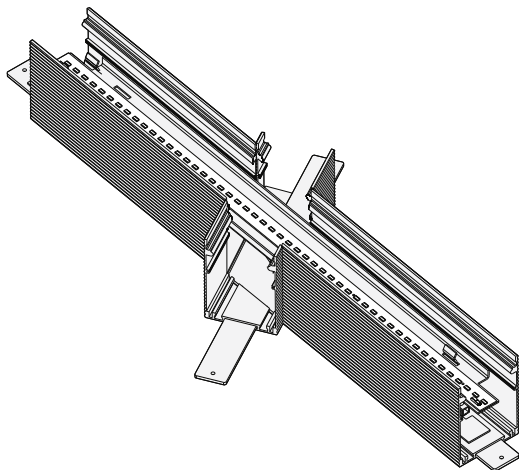

• UGR < 19 in funzione delle condizioni di installazione
UGR < 19 depending on installation conditions

Fotometrie e Classi Energetiche disponibili www.panzeri.it
Photometric data and Energy Label available at www.panzeri.it

Giunzione piana 90° - 345 mm con LED e driver dimmerabile
 DALI / PUSH DIM trimless
 Level junction 90° - 345 mm with LED and driver dimmable
 DALI / PUSH DIM trimless

XG2038-U90-300 ECO DALI

Potenza assorbita apparecchio/Luminaire power consumption 16W
 Flusso luminoso apparecchio/Luminaire luminous flux
 864lm OPAL / 1018lm PR
 3000K Ra80 220-240V DALI / PUSH DIM

XG2038-U90-300 DALI

Potenza assorbita apparecchio / Luminaire power consumption 24,5W
 Flusso luminoso apparecchio/Luminaire luminous flux
 1416lm OPAL / 1668lm PR
 3000K Ra80 220-240V DALI / PUSH DIM

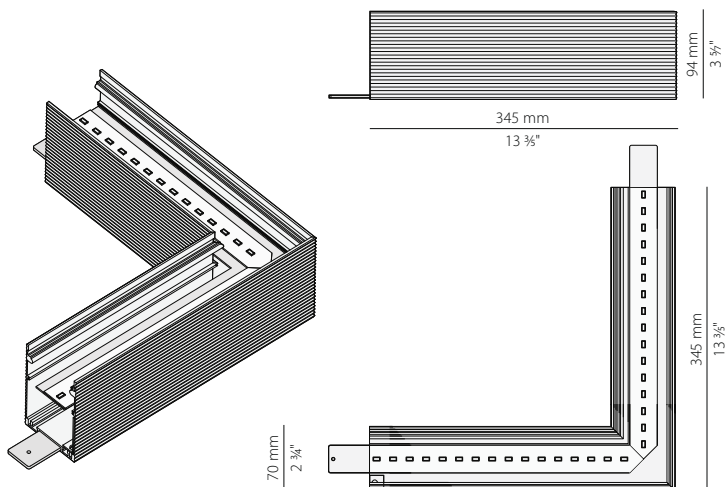

Giunzione piana 90° - 350 mm con LED e driver dimmerabile
 DALI / PUSH DIM trim
 Level junction 90° - 350 mm with LED and driver dimmable
 DALI / PUSH DIM trim

XG2039-U90-300 ECO DALI

Potenza assorbita apparecchio/Luminaire power consumption 16W
 Flusso luminoso apparecchio/Luminaire luminous flux
 864lm OPAL / 1018lm PR
 3000K Ra80 220-240V DALI / PUSH DIM

XG2039-U90-300 DALI

Potenza assorbita apparecchio / Luminaire power consumption 24,5W
 Flusso luminoso apparecchio/Luminaire luminous flux
 1416lm OPAL / 1668lm PR
 3000K Ra80 220-240V DALI / PUSH DIM

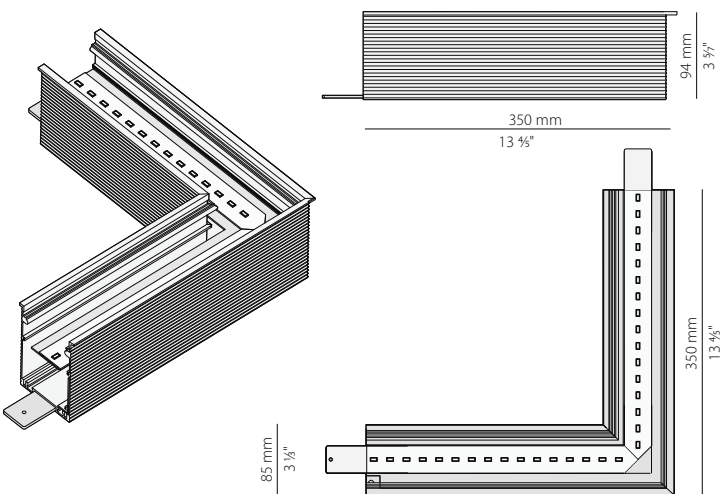

Giunzione piana 90° - 345 mm con LED e driver dimmerabile
 DALI / PUSH DIM trimless
 Level junction 90° - 345 mm with LED and driver dimmable
 DALI / PUSH DIM trimless

XG2038-U90-300 XP ECO DALI

Potenza assorbita apparecchio/ Luminaire power consumption 16W
 Flusso luminoso apparecchio/Luminaire luminous flux
 864lm OPAL / 1018lm PR
 3000K Ra80 220-240V DALI / PUSH DIM

XG2038-U90-300 XP DALI

Potenza assorbita apparecchio / Luminaire power consumption 24,5W
 Flusso luminoso apparecchio/Luminaire luminous flux
 1416lm OPAL / 1668lm PR
 3000K Ra80 220-240V DALI / PUSH DIM

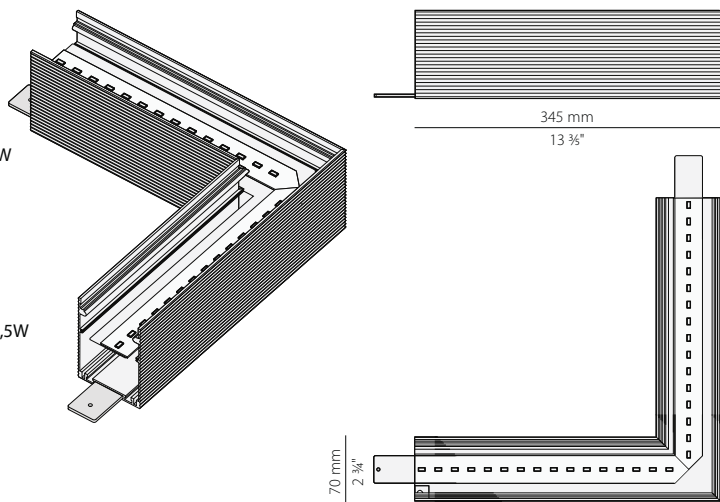

• UGR < 19 in funzione delle condizioni di installazione
 UGR < 19 depending on installation conditions

Fotometrie e Classi Energetiche disponibili www.panzeri.it
 Photometric data and Energy Label available at www.panzeri.it

XG2038-U90 (Non dimmerabile / No dimmable)

Giunzione piana 90° con LED e driver trimless
Level junction 90° with LED and driver trimless

Potenza assorbita apparecchio/ Luminaire power consumption 5W
Flusso luminoso LED/LED luminous flux 240lm 3000K Ra80 220-240V

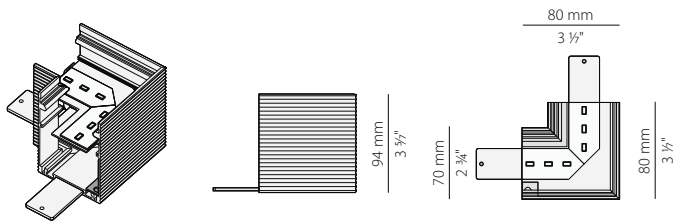
**XG2038-U90 XP** (Non dimmerabile / No dimmable)

Giunzione piana 90° con LED e driver
Level junction 90° with LED and driver

Potenza assorbita apparecchio/ Luminaire power consumption 5W
Flusso luminoso LED/LED luminous flux 240lm 3000K Ra80 220-240V

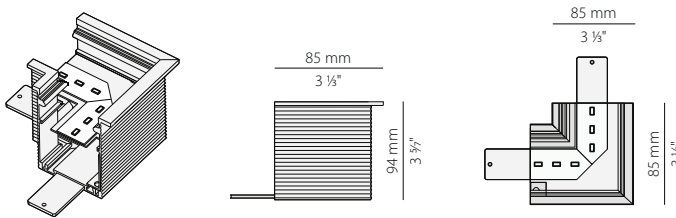
**XG2039-U90** (Non dimmerabile / No dimmable)

Giunzione piana 90° con LED e driver trim
Level junction 90° with LED and driver trim

Potenza assorbita apparecchio/ Luminaire power consumption 5W
Flusso luminoso LED/LED luminous flux 240lm 3000K Ra80 220-240V

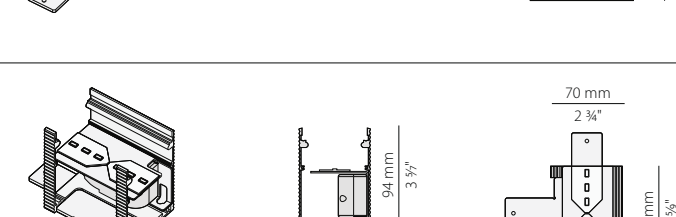
**XG2038-UT** (Non dimmerabile / No dimmable)

Giunzione a T con LED e driver trimless
T junction with LED and driver trimless

Potenza assorbita apparecchio/ Luminaire power consumption 5W
Flusso luminoso LED/LED luminous flux 240lm 3000K Ra80 220-240V

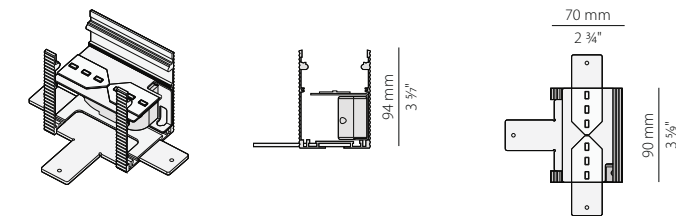
**XG2038-X** (Non dimmerabile / No dimmable)

Giunzione a X con LED e driver trimless
X junction with LED and driver trimless

Potenza assorbita apparecchio/ Luminaire power consumption 4W
Flusso luminoso LED/LED luminous flux 120lm 3000K Ra80 220-240V

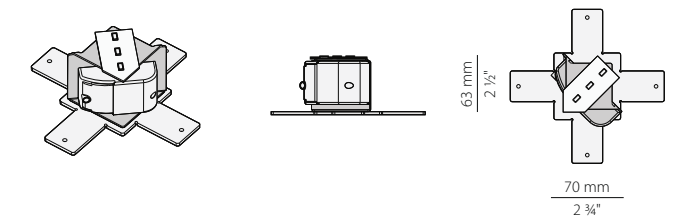
**XM2038-U90**

Giunzione piana 90° vuota trimless
Level junction 90° trimless empty

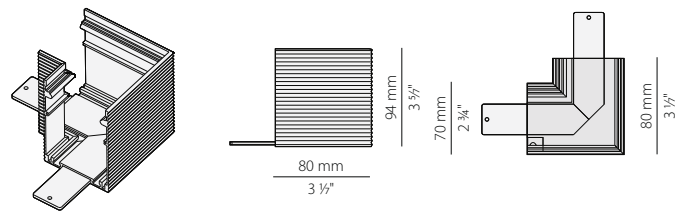
**XM2038-U90 XP**

Giunzione piana 90° vuota
Level junction 90° empty

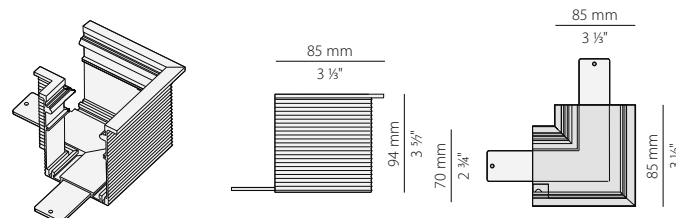
**XM2039-U90**

Giunzione piana 90° vuota trim
Level junction 90° trim empty

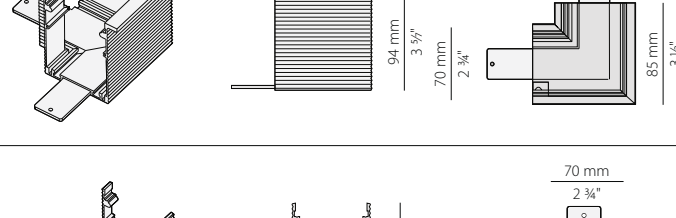
**XM2038-UT**

Giunzione a T vuota trimless
T junction trimless empty

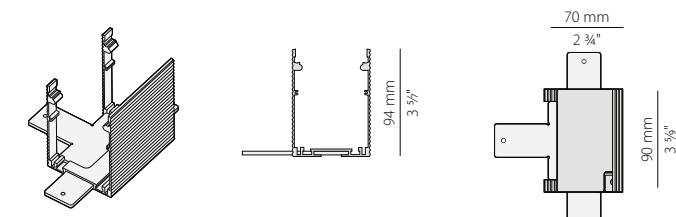

• UGR < 19 in funzione delle condizioni di installazione
UGR < 19 depending on installation conditions

Fotometrie e Classi Energetiche disponibili www.panzeri.it
Photometric data and Energy Label available at www.panzeri.it

XM2038-X

Giunzione a X vuota trimless
X junction trimless empty

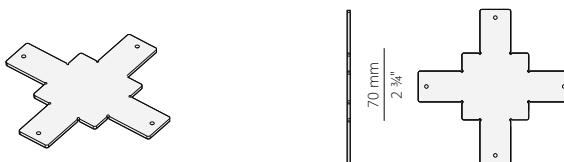
**XM2038/39-ANG**

Accessorio per angolo verticale 150x150 mm
Junction for vertical angle 150x150 mm

**XM2038/39-U**

Giunzione lineare
Linear junction

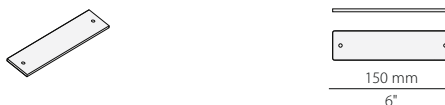
**XM2038/39-260S**

Diffusore opalino mm 2600 / Opal polycarbonate diffuser mm 2600

XM2038/39-380S

Diffusore opalino mm 3800 / Opal polycarbonate diffuser mm 3800

XM2038/39-260S PR

Diffusore microprismato mm 2600 / Microprismate diffuser mm 2600

XM2038/39-380S PR

Diffusore microprismato mm 3800 / Microprismate diffuser mm 3800

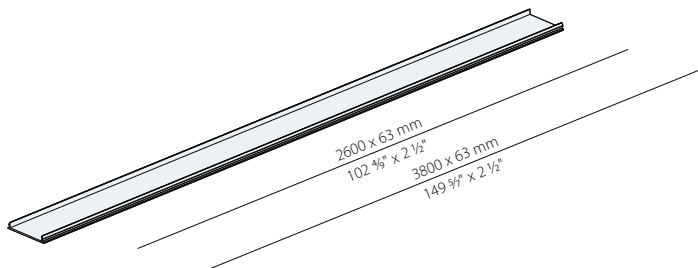
**XM2038-T**

Coppia di elementi terminali con viti trimless
Two trimless end segments with screws

XM2039-T

Coppia elementi terminali con viti trim
Two trim end segments with screws

XM2038-T1

Coppia di elementi terminali con viti (XP2038)
Two end segments with screws (XP2038)

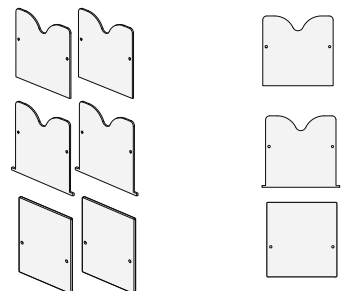
**XM2038-F**

Farfalla di fissaggio versione trimless per cartongesso regolabile (posizionabile ogni 400 mm circa)
Wing nut trimless version for adjustable drywall (can be placed every 400 mm approx)

XM2039-F

Farfalla di fissaggio versione trim per cartongesso regolabile (posizionabile ogni 400 mm circa)
Wing nut trim version for adjustable drywall (can be placed every 400 mm approx)

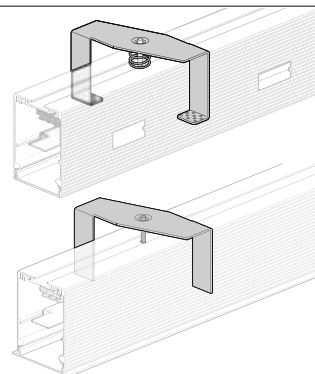
**XM2033/34/38/39P**

Piastrina per eventuale appendimento
Plate for eventual hanging

**XM2038/39-L**

Coppia piastrine fissaggio su laterizio
Plates couple for brickfixing



XM2038-A

(Per angoli e giunzioni XP2038 / For corner and junctions XP2038)
Coppia copri luce adesivo lineare / Pair of linear adhesive light cover

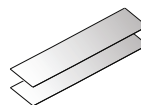

XM2038/46-3

Kit di alimentazione 3 poli + cavo lunghezza cm 220. Rosone bianco
Power Supply Kit with 3-pole cable cm 220 lenght. White canopy

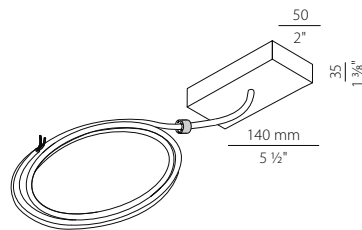

XM2038/46-5

Kit di alimentazione 5 poli + cavo lunghezza cm 220. Rosone bianco
Power Supply Kit with 5-pole cable cm 220 lenght. White canopy

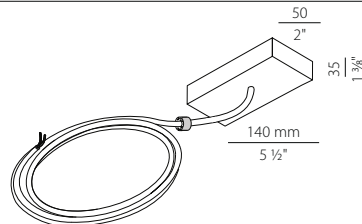

XM-KIT-S

Singolo elemento di sospensione
Single suspension kit

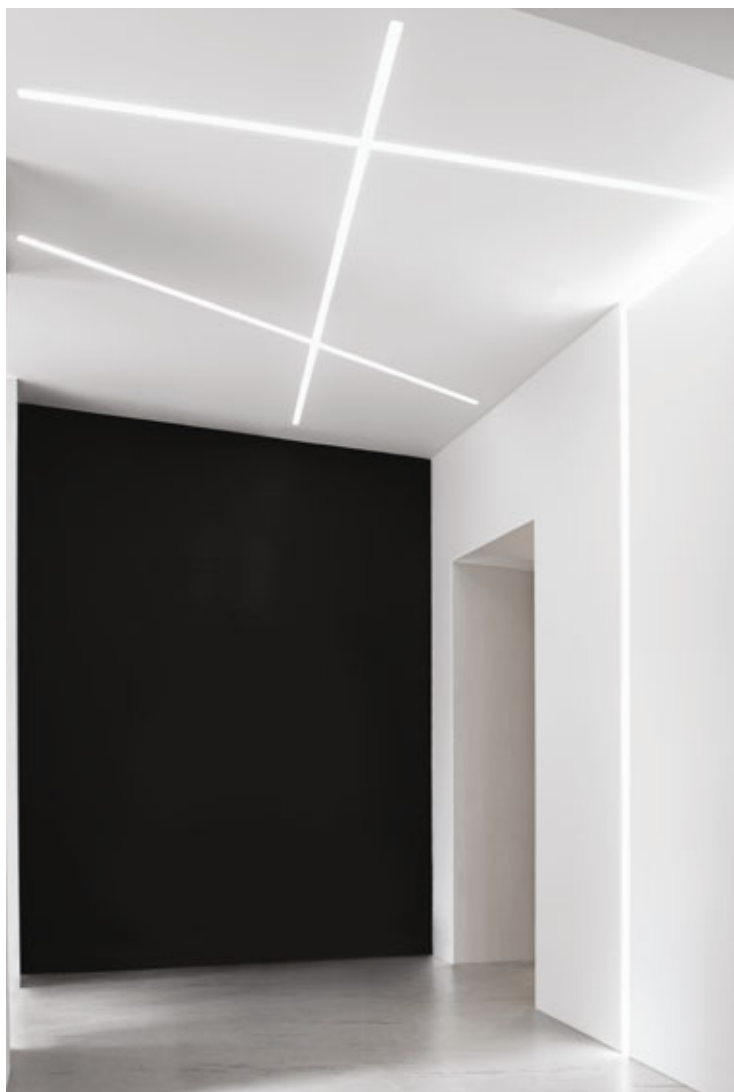





CONFINDUSTRIA
Monza e Brianza

NOLITA - NOLITA ECO

XG2038

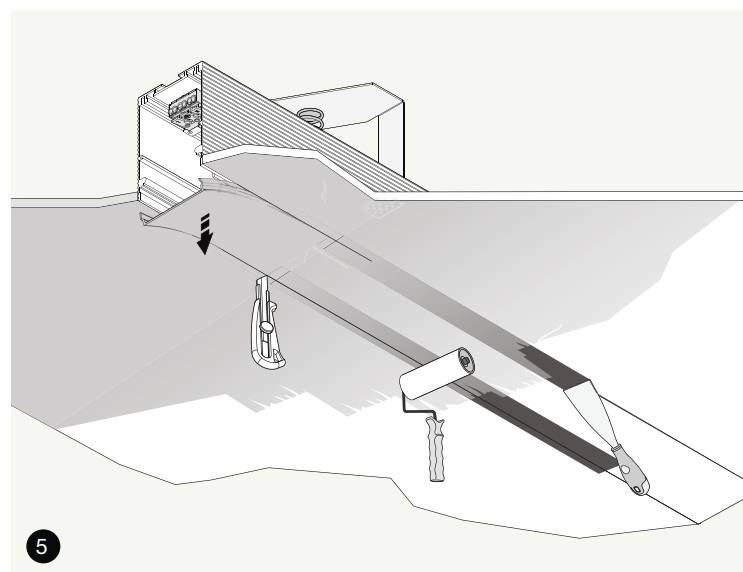
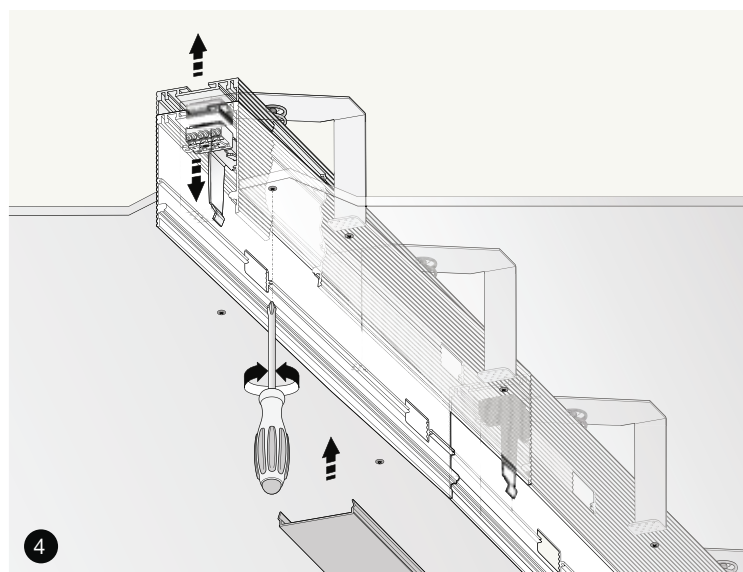
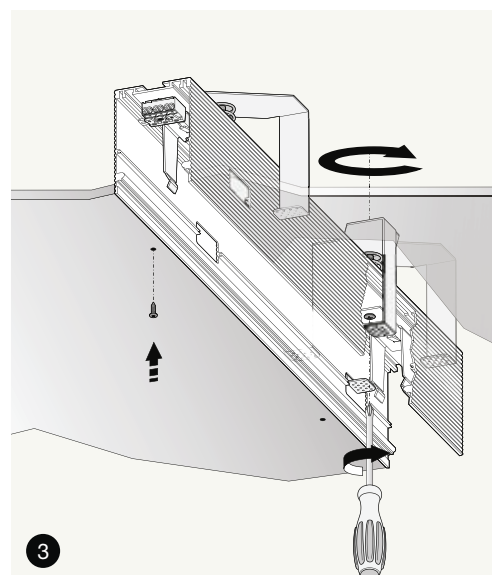
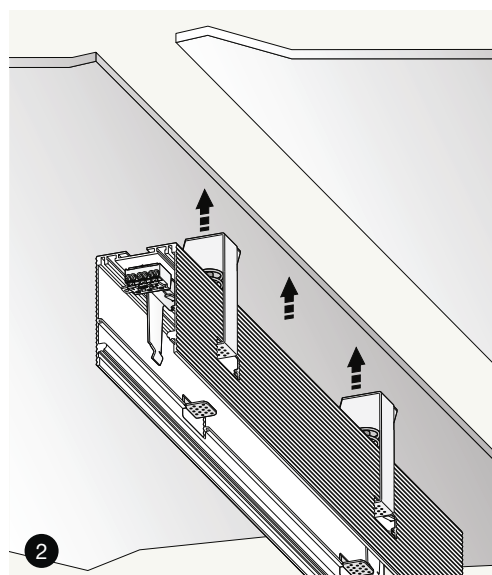
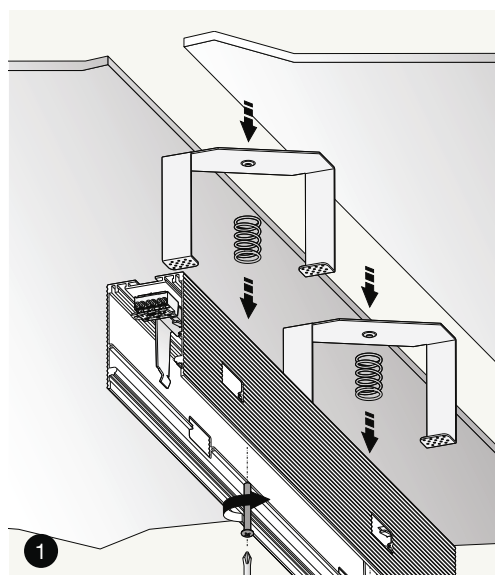
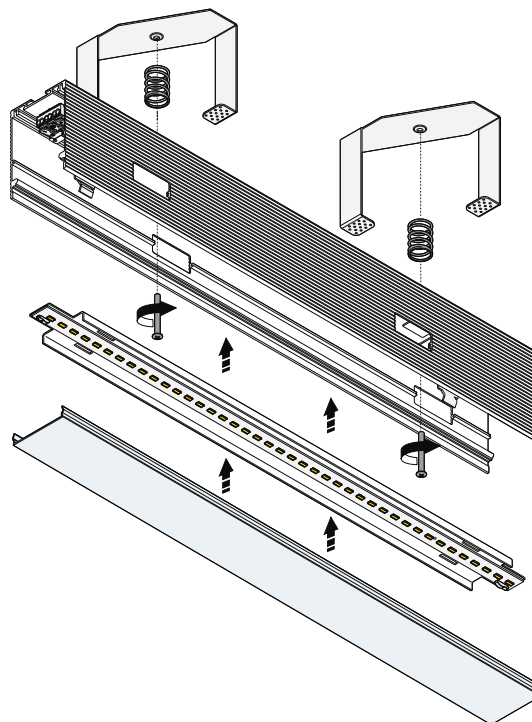
XG2038 ECO



XM2038/39-U
Giunzione lineare
Linear junction

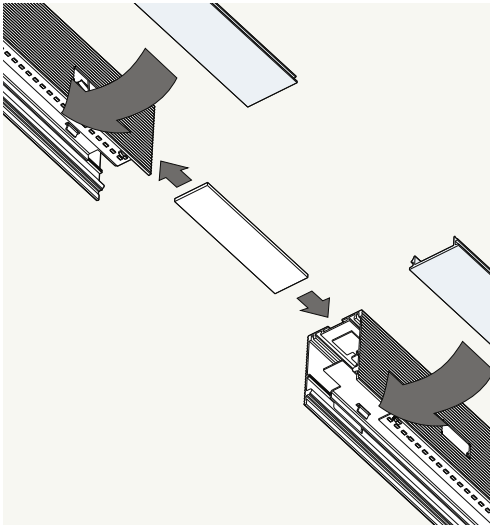

XM2038/39-ANG
Giunzione 90° trimless parete-soffitto
90° wall to ceiling trimless junction

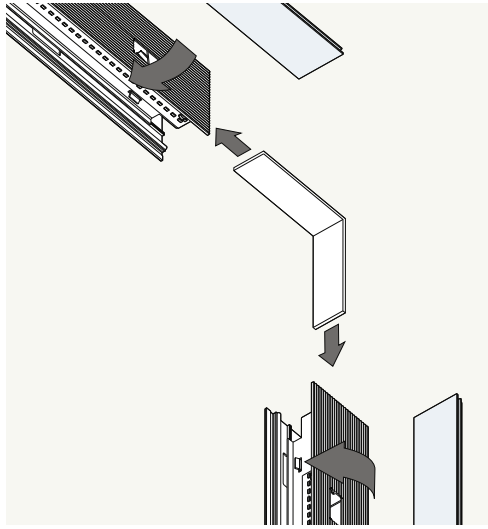

XG2038-U90
Giunzione piana 90° trimless con LED e driver
Level junction 90° trimless with LED and driver

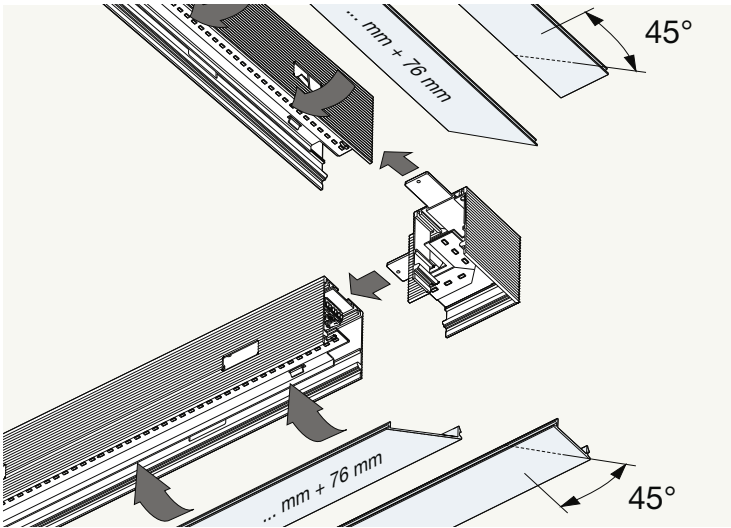

XG2038-UT
Giunzione a T trimless con LED e driver
T junction trimless with LED and driver

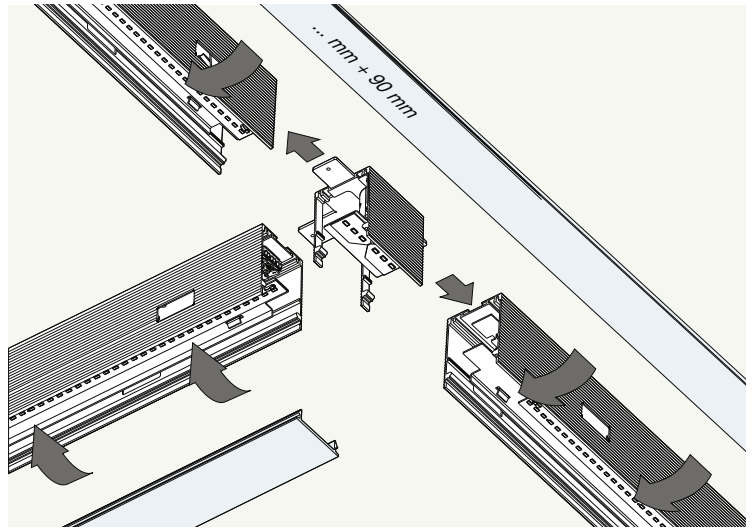

XG2038-X
Giunzione a X trimless con LED e driver
X junction trimless with LED and driver

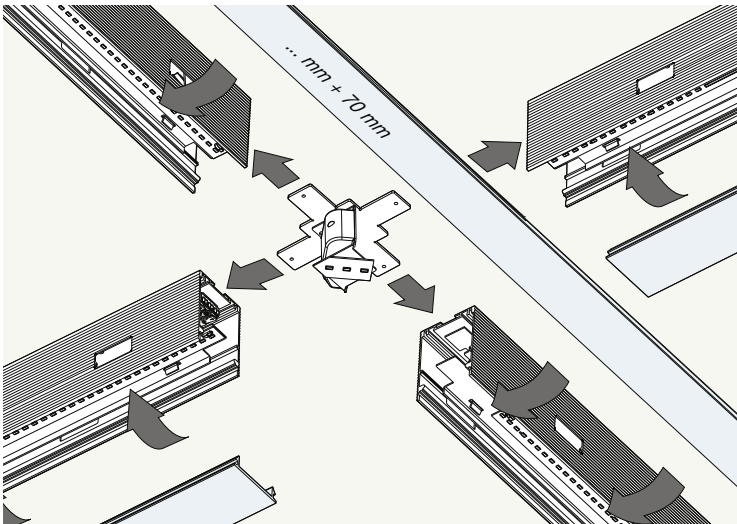

XG2038-ANG 60/120
Angolo 60/120 trimless con LED e driver
60/120 angle trimless with LED and driver

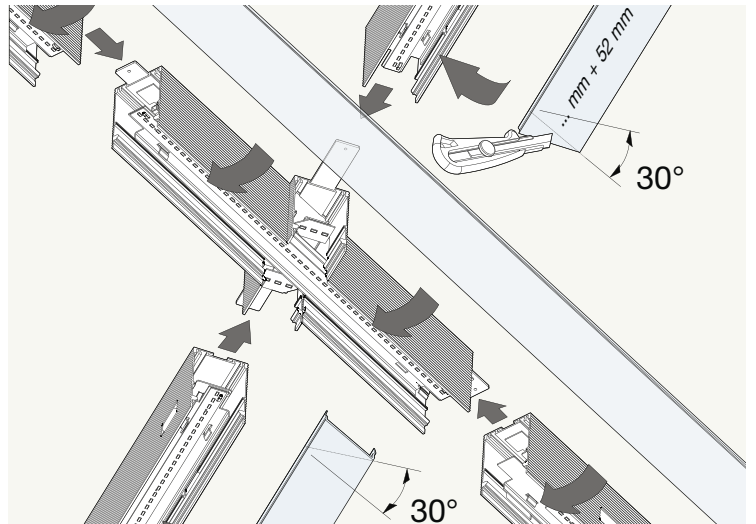

NOLITA TRIM XG2039
NOLITA TRIM ECO XG2039 ECO

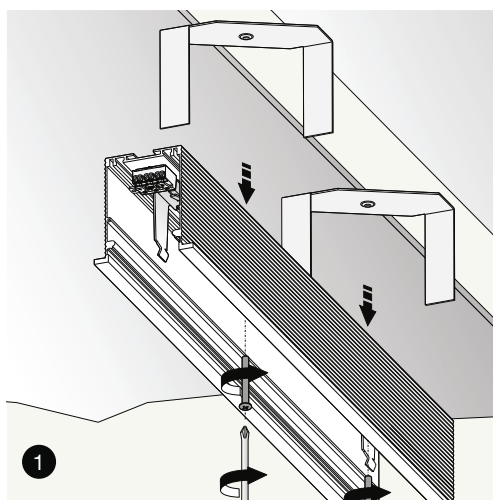
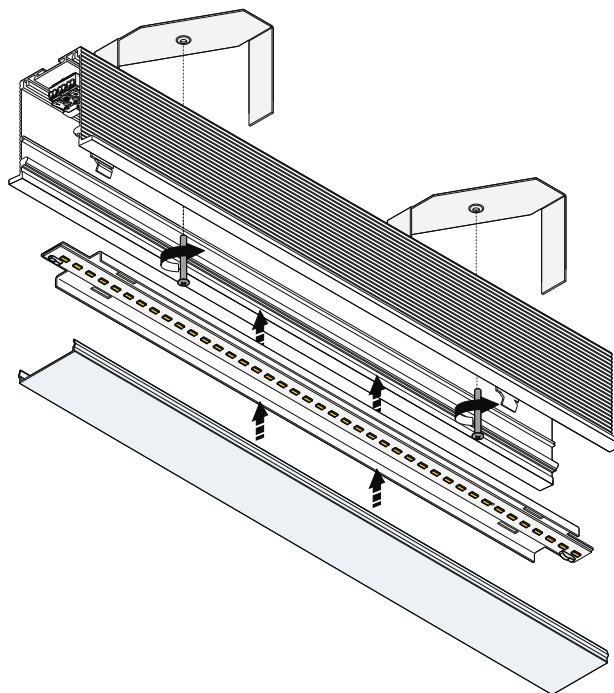

XM2038/39-U
 Giunzione lineare
 Linear junction

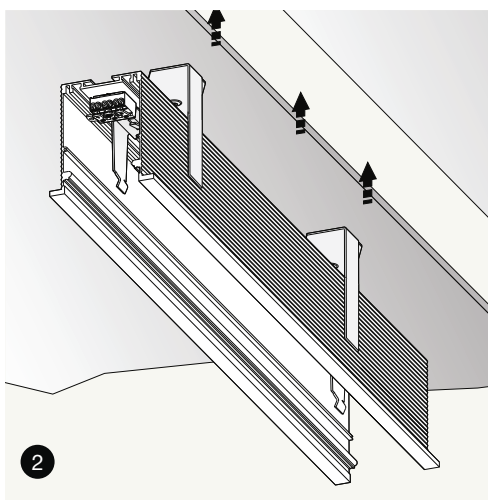

XM2038/39-ANG
 Giunzione 90° trim parete-soffitto
 90° wall to ceiling trim junction

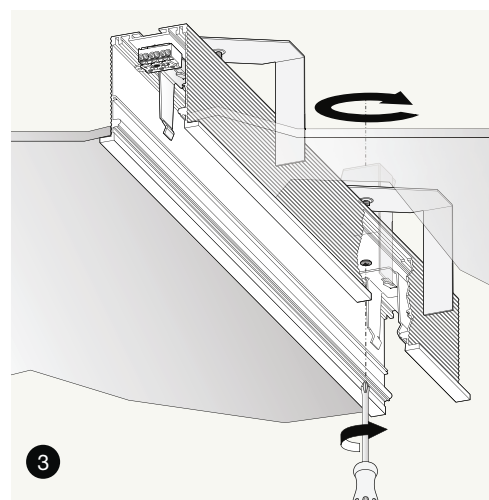

XG2039-U90
 Giunzione piana 90° trim con LED e driver
 Level junction 90° trim with LED and driver

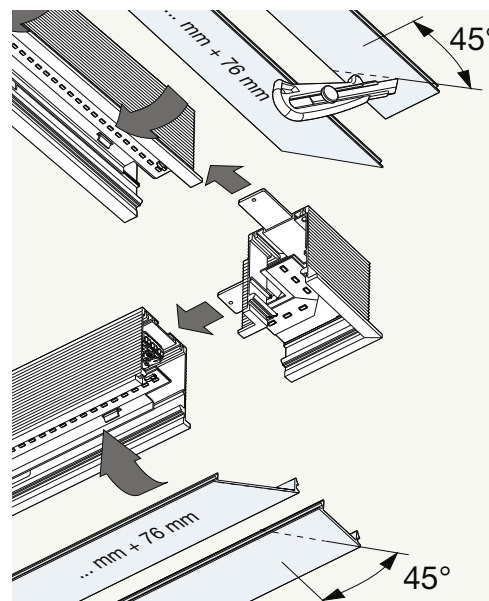
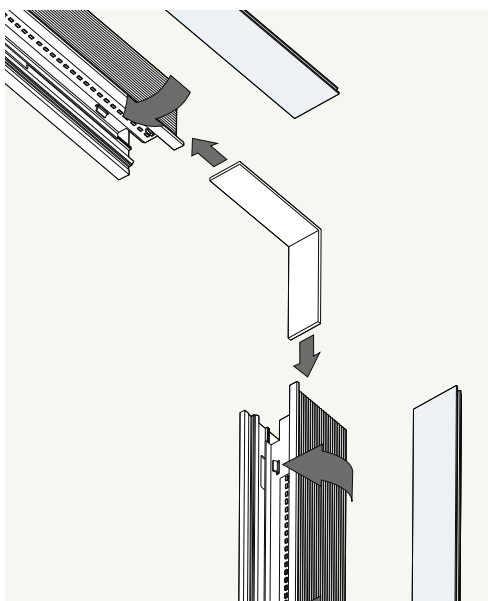
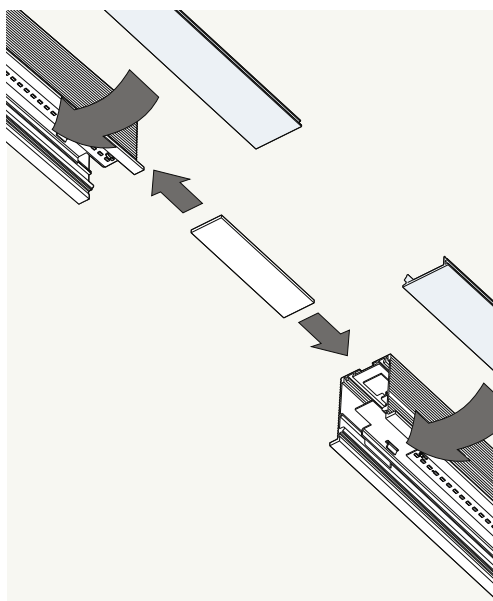

NOLITA OUT XP2038
NOLITA OUT ECO XP2038 ECO

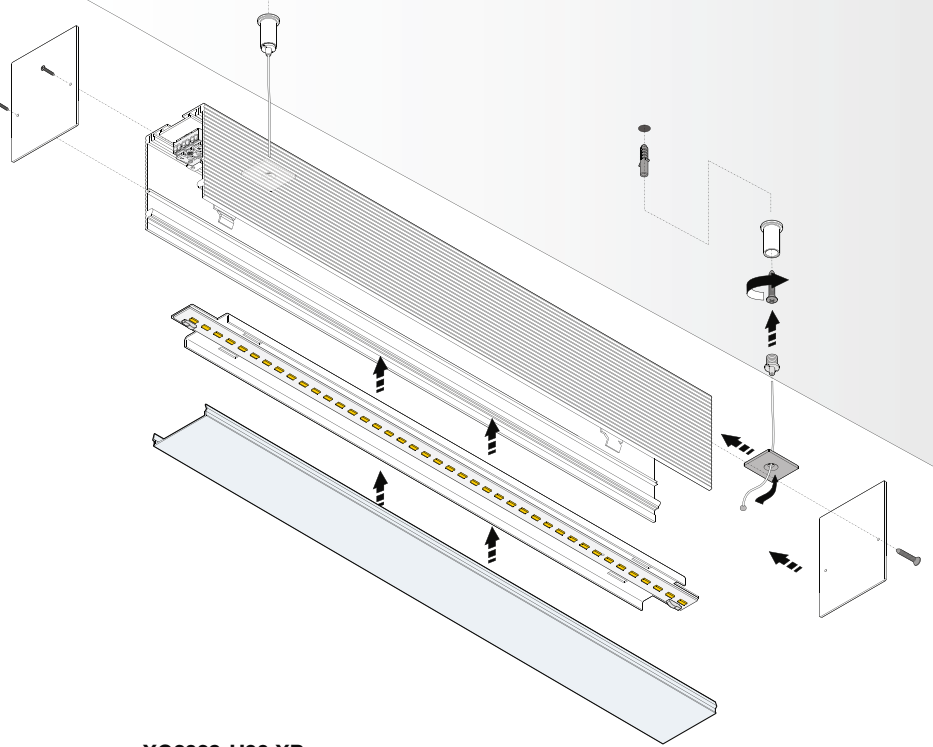

XM2038/39-U
 Giunzione lineare
 Linear junction

• XM2038-A

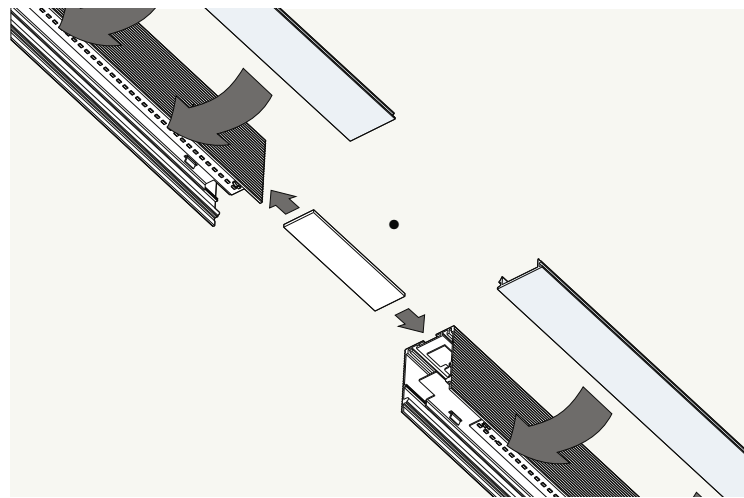

XG2038-U90 XP
 Giunzione piana 90° con LED e driver
 Level junction 90° with LED and driver

• XM2038-A

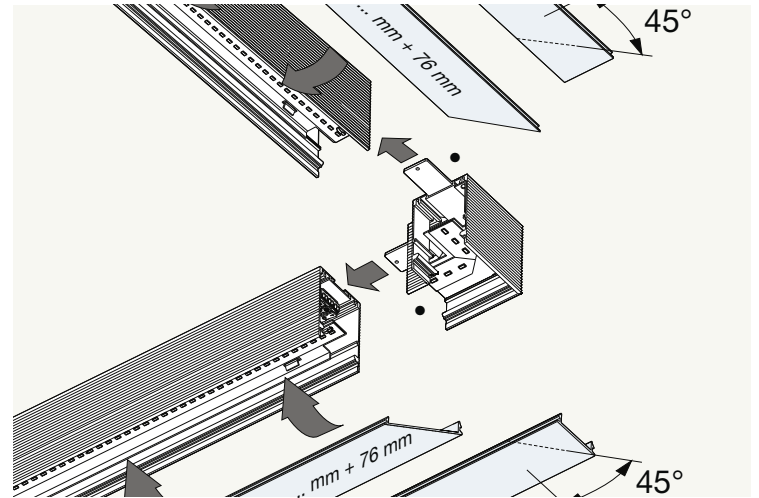

XG2038-UT
 Giunzione a T con LED e driver
 T junction with LED and driver

• XM2038-A

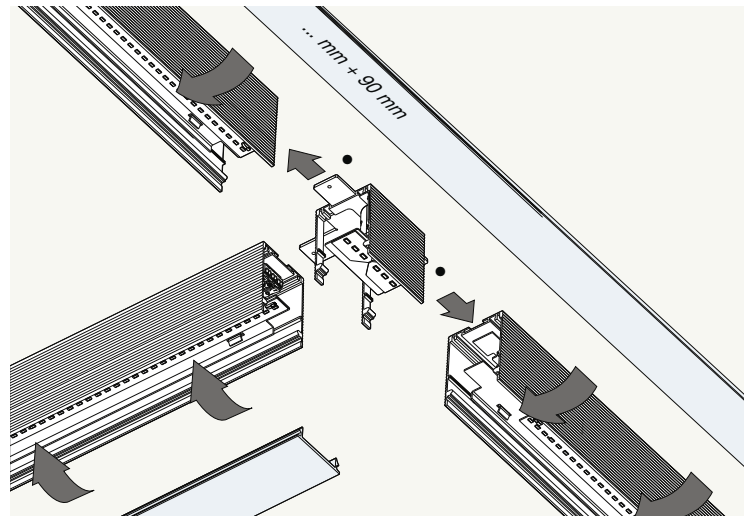

XG2038-X
 Giunzione a X con LED e driver
 X junction with LED and driver

• XM2038-A

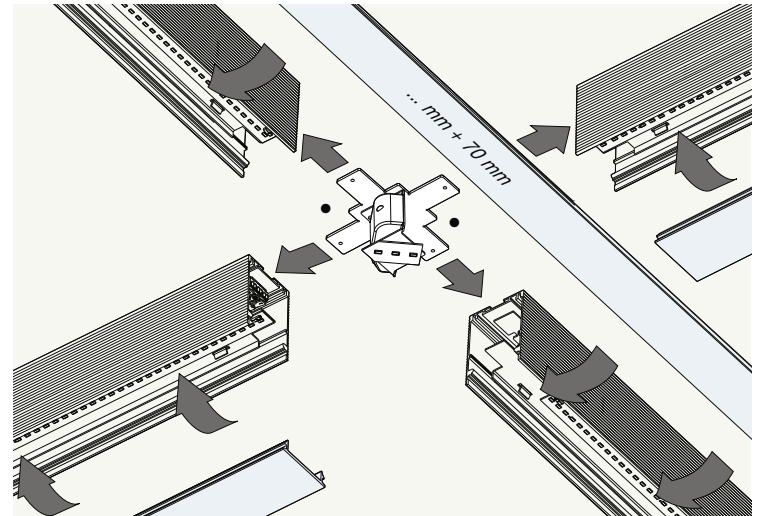

MANHATTAN

Made in Italy

Sistema modulare LED in alluminio estruso verniciato bianco, da incasso a scomparsa totale (trimless) per applicazioni in cartongesso. Oltre alla possibilità di installazione a parete e soffitto, in posizione orizzontale e verticale, si presta in modo particolare per installazioni perimetrali. Grazie alla riflessione della luce interna, il profilo non necessita di un diffusore in policarbonato.

Trimless modular LED system in extruded aluminum painted white for total recessed use in false ceiling. Besides the possibility of horizontal or vertical installation on walls and ceilings, this system is particularly suitable for perimeter installation. Due to the reflection of the internal light, this profile does not require a polycarbonate diffuser.

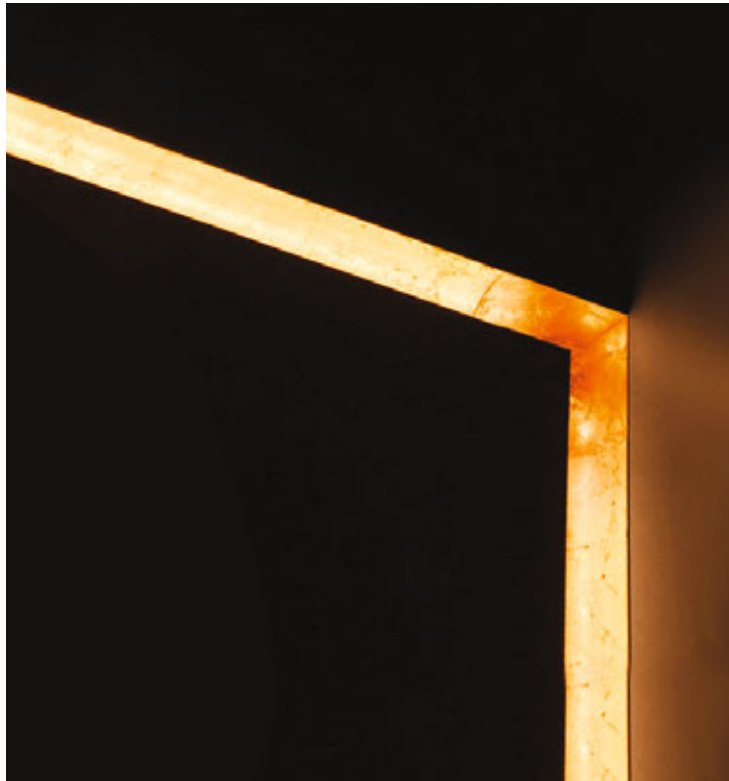





MANHATTAN

XG2044 □



(XG2044-TRACK + XM1ROW HO or XM1ROWHD + XG2044-T)

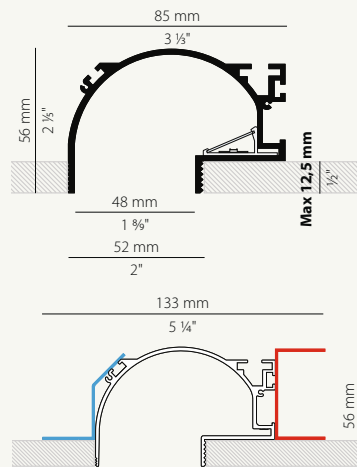

Electric options	page 518
Dimming	522-523
Technical information	526
Wiring diagram 2-3	526-527

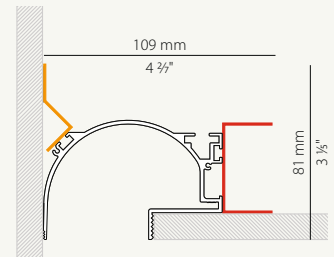

Profilo in alluminio estruso verniciato bianco compreso supporto LED in alluminio estruso e policarbonato

Aluminium profile painted white including LED support in extruded aluminium and polycarbonate

MANHATTAN



PROFILE	□ CODICE / CODE	L MM	L INCHES	MM	INCHES	NR. XM2044-F XM2044-FP ADVISED
Supporto in alluminio per LED con diffusore policarbonato inclusi Aluminium LED frame and polycarbonate diffuser included	XG2044-50 TRACK	420	16 5/8"	425 x 58	16 3/4 x 2 3/8"	2
	XG2044-100 TRACK	920	36 1/4"	925 x 58	36 5/8 x 2 3/8"	2
	XG2044-200 TRACK	1920	75 3/8"	1925 x 58	75 5/8" x 2 3/8"	3
	XG2044-300 TRACK	2920	115"	2925 x 58	115 1/4" x 2 3/8"	4



21 Foglia oro (a richiesta)
Gold leaf
(available on request)



23 Foglia argento (a richiesta)
Silver leaf
(available on request)

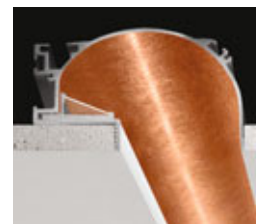

24 Foglia Rame (a richiesta)
Copper leaf
(available on request)

XM1ROW HO/3MT

STRIP ROLL 1 ROW 3 MT 3000K Ra80 24V



3 x 168 led/mt - 3 x 35 W/mt
3 x 2833lm/mt



Eventuali tagli e saldature su rollina
XM1Row HO/3mt sono da quantificare a progetto.
Required cutting and welding on
XM1Row HO/3mt roll are to be calculated for each project.

Disponibili anche rolle LED vedi pagina 519 electric options.
Matrice di compatibilità LED Profile Matrix pagina 488
Also available LED rolls see page 519 electric options. LED Profile Matrix page 488

STRIP ROLL 1 ROW HD STRIP ROLL 1 ROW HF

Per alimentatori vedi pagina 522 electric options
For power supplies see on page 522 electric options

Fotometrie e Classi Energetiche disponibili www.panzeri.it
Photometric data and Energy Label available at www.panzeri.it

XM2044-U90 1

Angolo 1 piano 90° parete-parete/soffitto-soffitto misure esterne 110x110mm
Angle 1 horizontal 90° wall-wall / ceiling-ceiling, external measurements 110x110mm

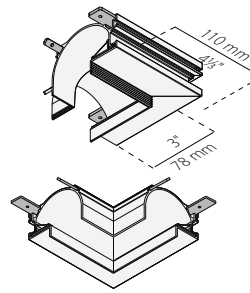

Vista laterale / Side view

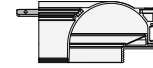

Vista inferiore / Bottom view

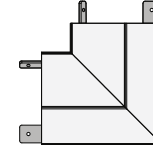

XM2044-U90 2

Angolo 2 piano 90° parete-parete/soffitto-soffitto misure esterne 110x110mm
Angle 2 horizontal 90° wall-wall / ceiling-ceiling, external measurements 110x110mm

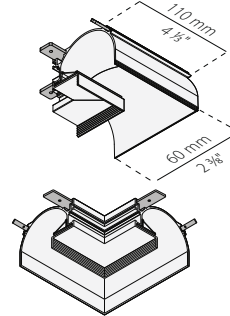

Vista laterale / Side view

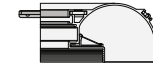

Vista inferiore / Bottom view

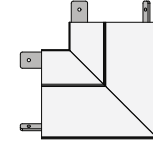

XM2044-ANG 3

Angolo 3 verticale 90° parete-soffitto/parete-parete misure esterne 110x110mm
Angle 3 vertical 90° wall-ceiling / wall-wall, external measurements 110x110mm

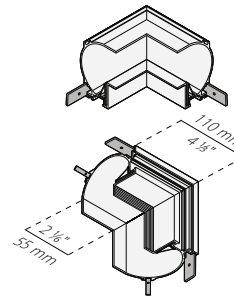

Vista laterale / Side view



Vista inferiore / Bottom view

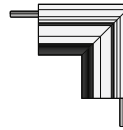

XM2044-ANG 4

Angolo 4 orizzontale 90° parete-parete misure esterne 110x110mm
Angle 4 horizontal 90° wall-wall, external measurements 110x110mm

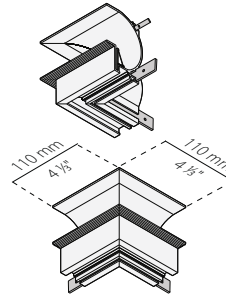

Vista laterale / Side view

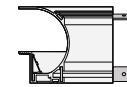

Vista inferiore / Bottom view

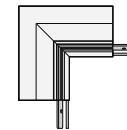

XM2044-U

Kit giunzione lineare / Linear junctions kit

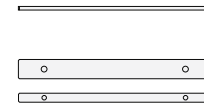
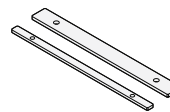

XM2044-TA

Vano alimentazione (opzionale) con viti da fissare sulla giunzione
Power compartment (optional) with screws for installation on the junction

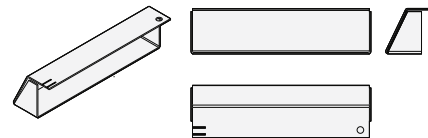

XM2044-T

Coppia elementi terminali con viti / Pair of end segments with screws



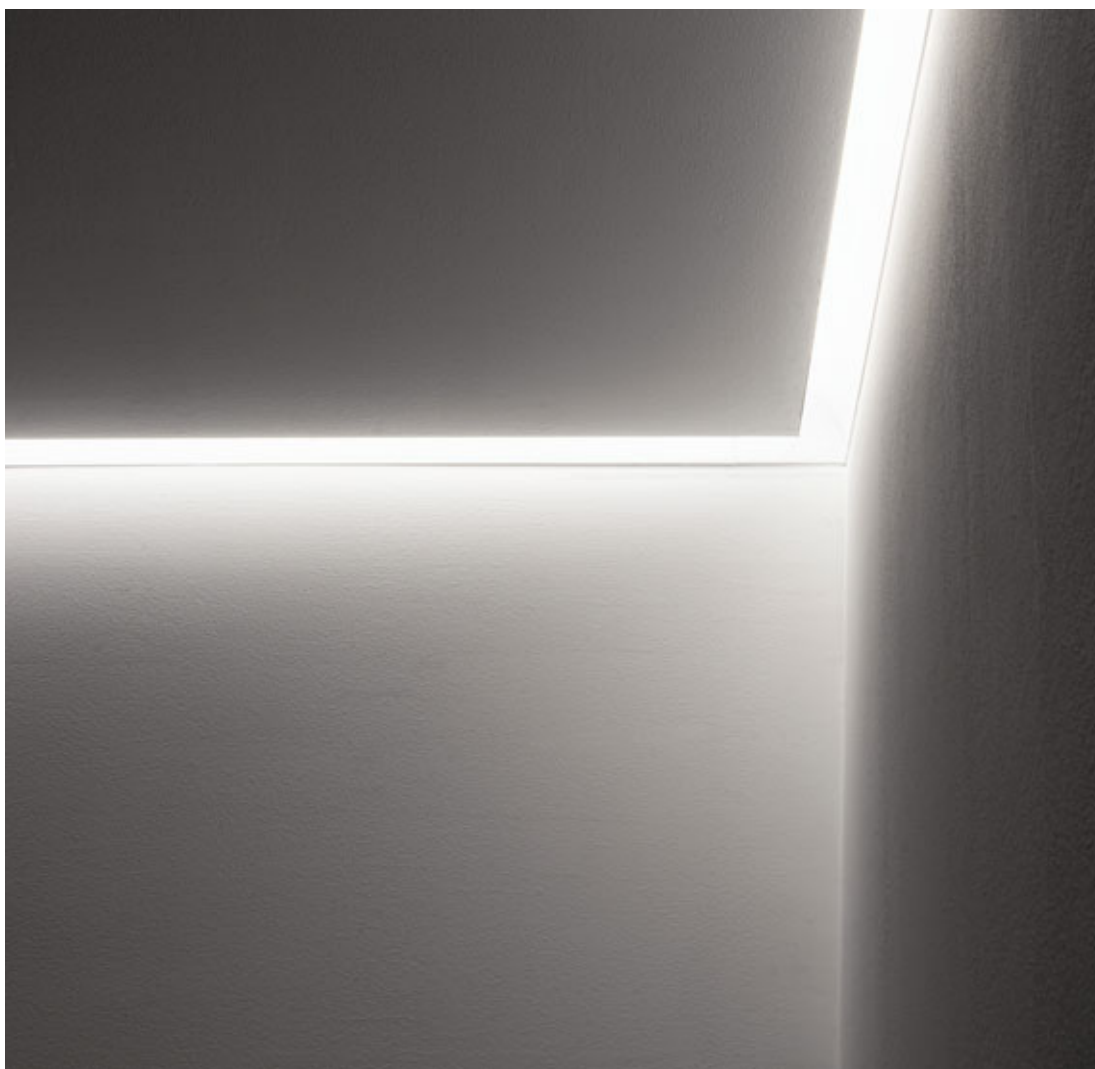

XM2044-F

Kit staffe fissaggio per cartongesso / Kit of brackets for false ceiling installations

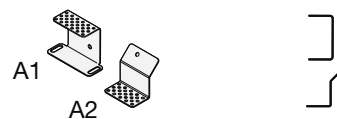

XM2044-FP

Kit staffe fissaggio filo parete / Kit of brackets for flush wall installations

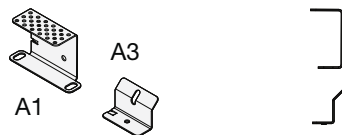

XM2044-P

Piastrina per appendimento a soffitto / Plate for hanging from ceiling



In considerazione della particolare forma del prodotto e delle eventuali sfumature di colore lungo e tra gli elementi del sistema XG2044, si evidenzia che è cura dell'installatore abbinare i pezzi adiacenti in modo da ottenere più uniformità possibile di colore. Nessuna responsabilità è imputabile al produttore.

Given the particular shape of the product and the eventual colour shades along and between the elements of system XG2044, please note that the installer has the responsibility to match the adjacent pieces so as to obtain the best colour uniformity. The manufacturer does not accept any liability.

XM2044-U
Giunzione lineare
Linear junction

XM2044-U90 1
Angolo 1 piano 90° parete-parete / soffitto-soffitto misure esterne 110x110mm
Angle 1 horizontal 90° wall-wall / ceiling-ceiling, external measurements 110x110mm

XM2044-U90 2
Angolo 2 piano 90° parete-parete / soffitto-soffitto misure esterne 110x110mm
Angle 2 horizontal 90° wall-wall / ceiling-ceiling, external measurements 110x110mm

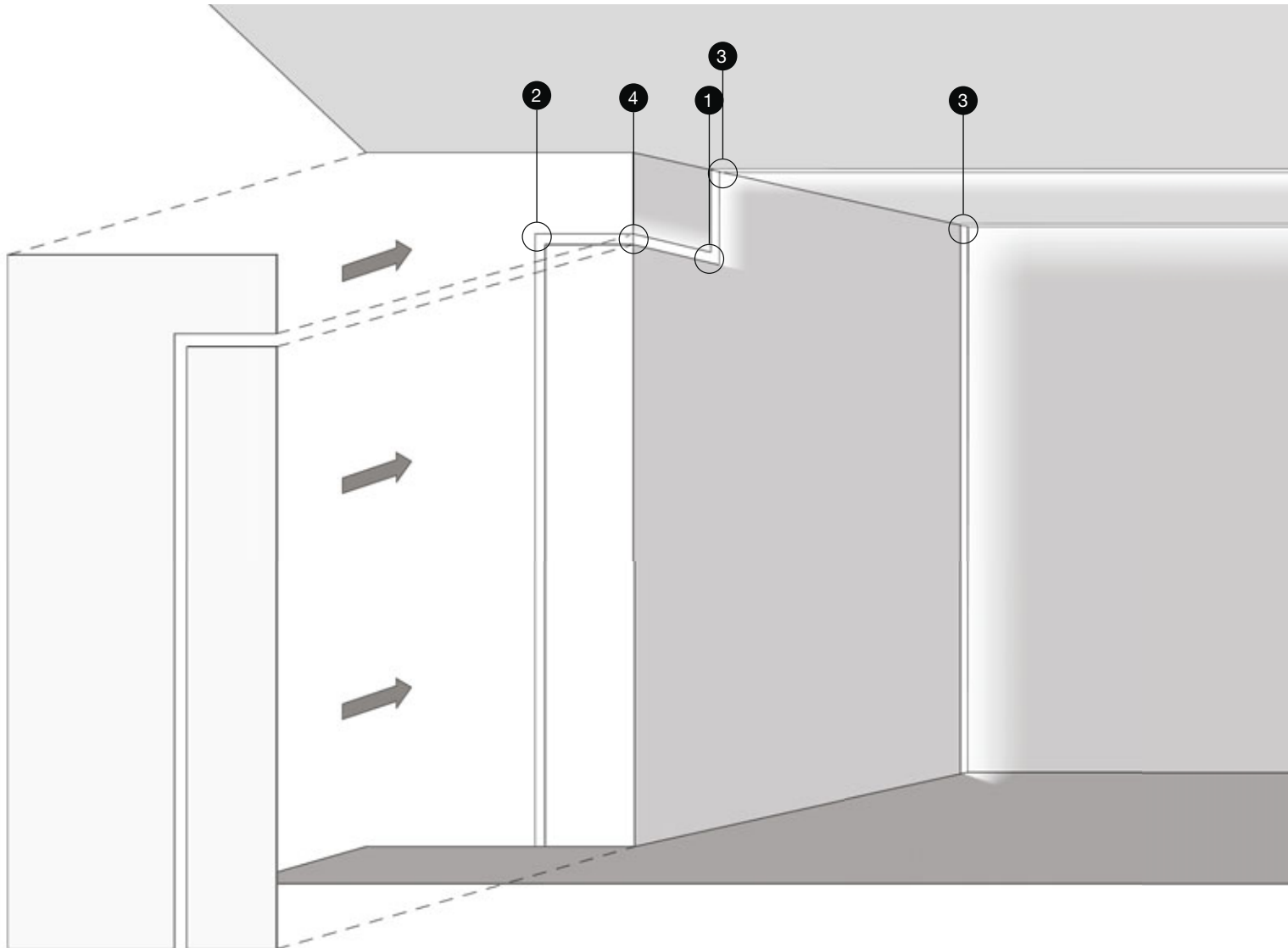
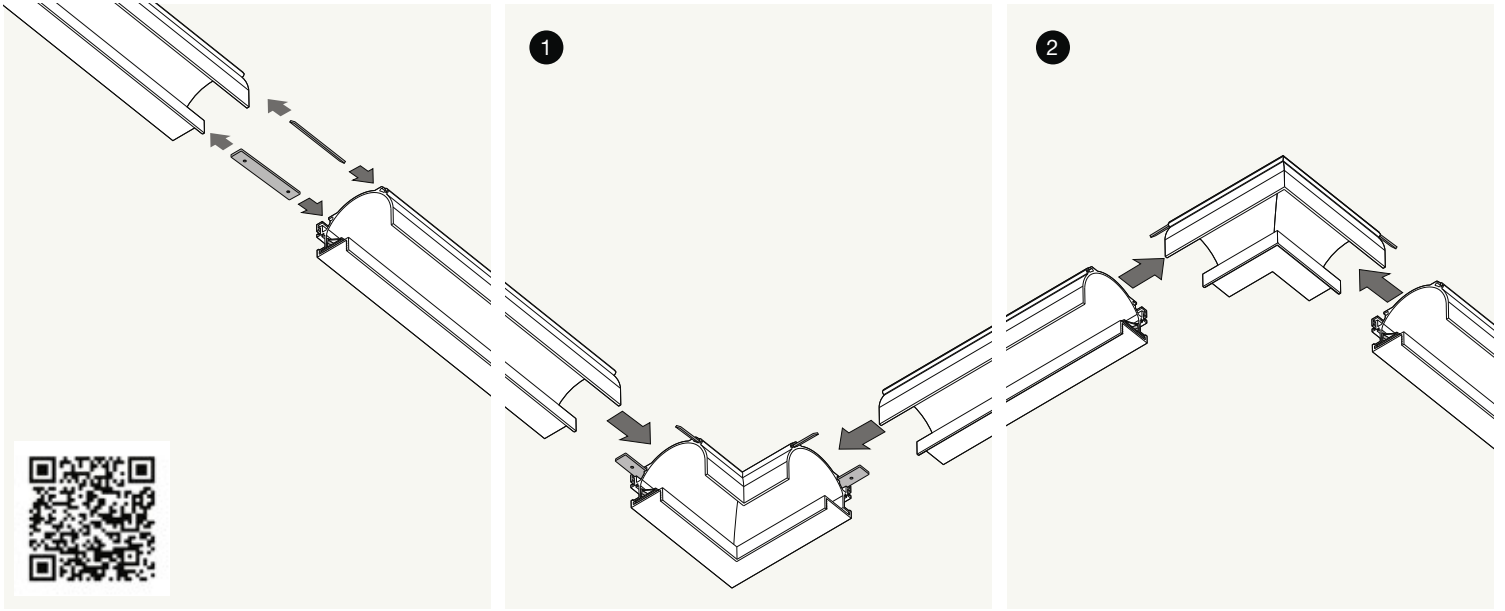

XM2044-ANG 3

Angolo 3 verticale 90° parete-soffitto/parete-parete misure esterne 110x110mm

Angle 3 vertical 90° wall-ceiling / wall-wall, external measurements 110x110mm

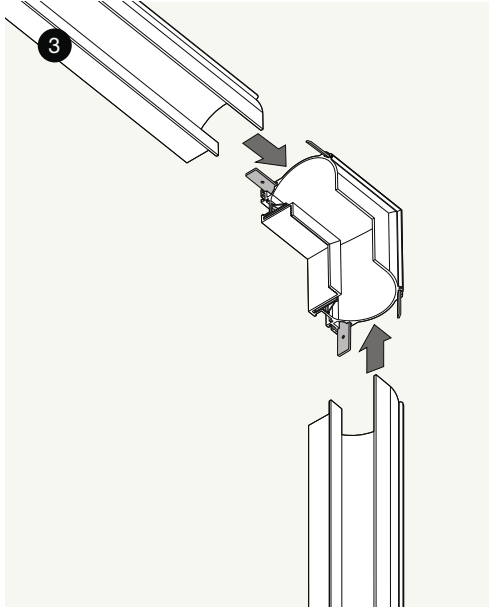
**XM2044-ANG 4**

Angolo 4 orizzontale 90° parete-parete misure esterne 110x110mm

Angle 4 horizontal 90° wall-wall, external measurements 110x110mm

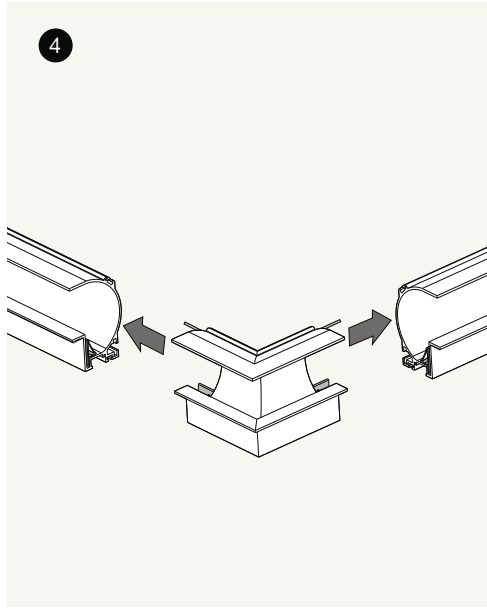
**XM2044-TA**

Vano alimentazione (opzionale) con viti da fissare sulla giunzione

Power compartment (optional) with screws for installation on the junction

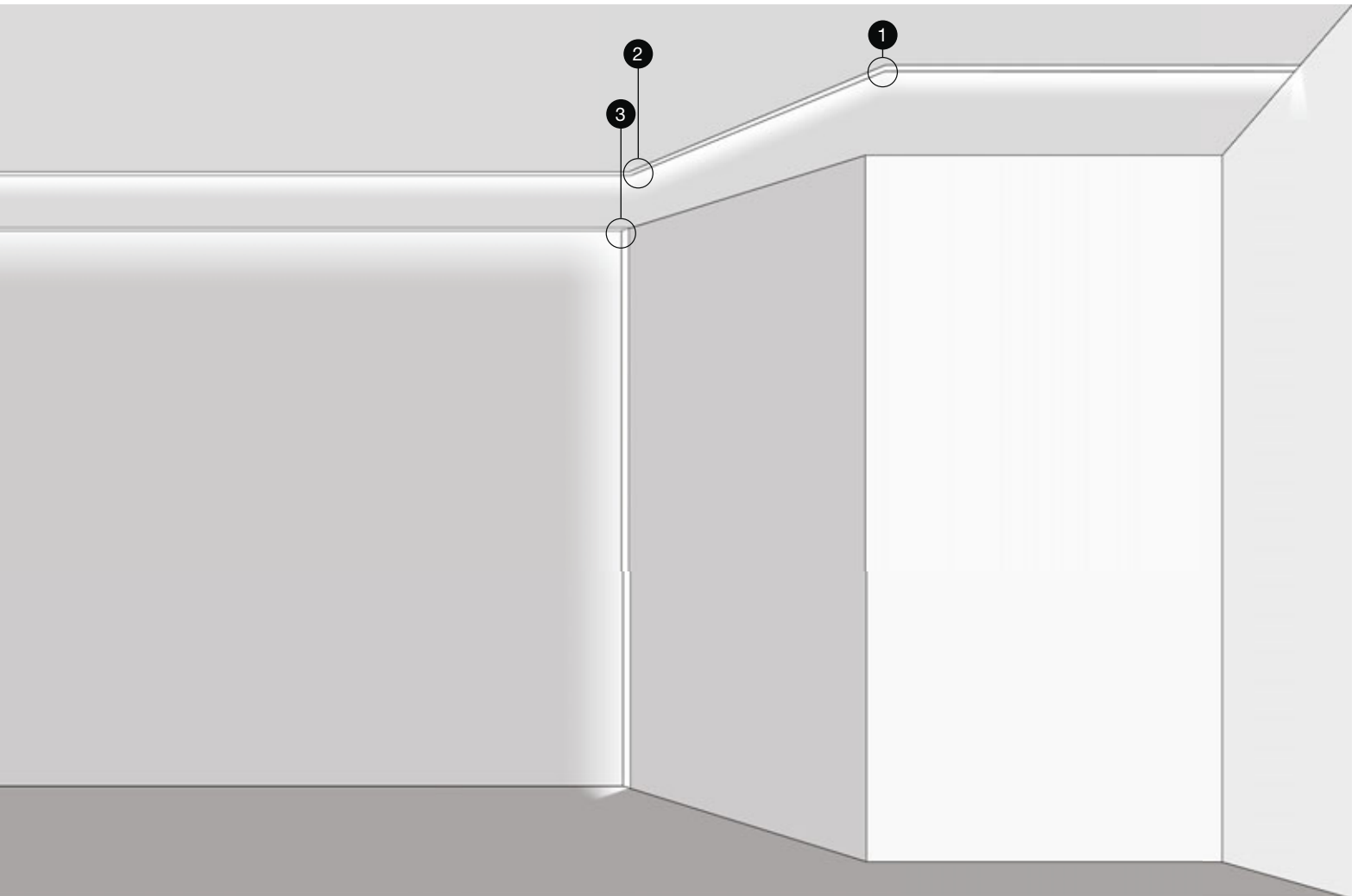
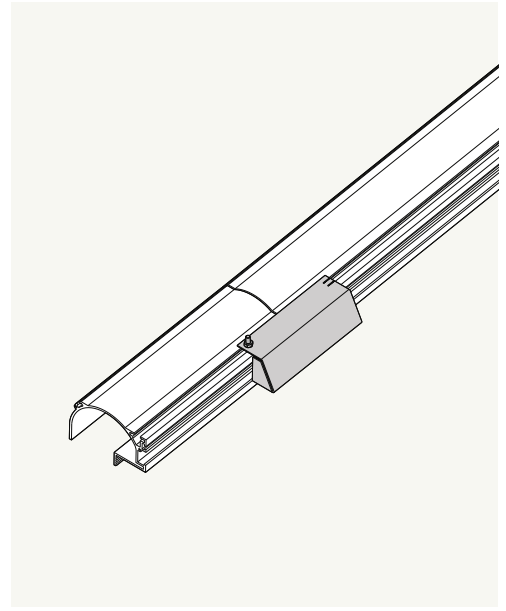

ESEMPI DI INSTALLAZIONE / INSTALLATION EXAMPLE

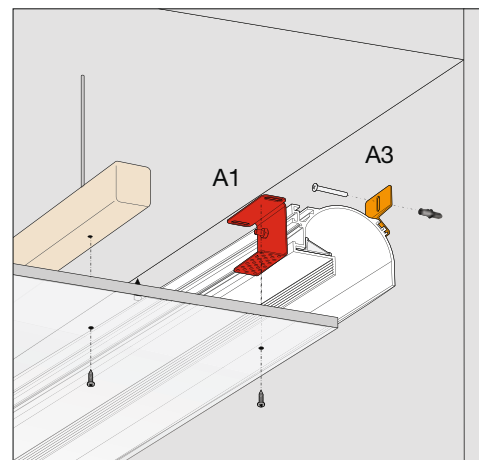
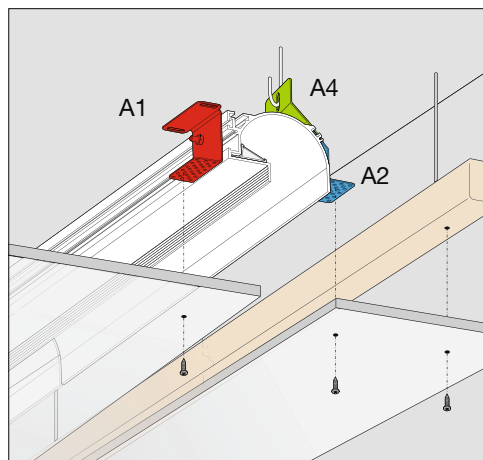
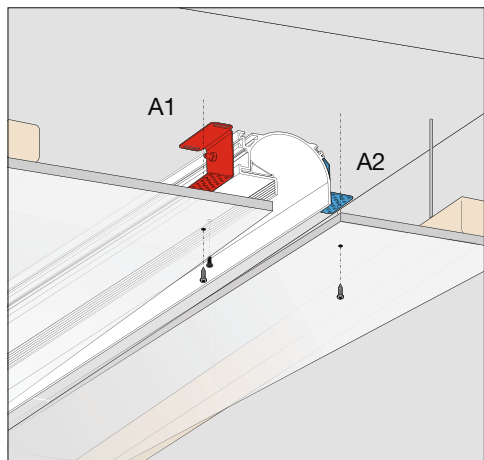
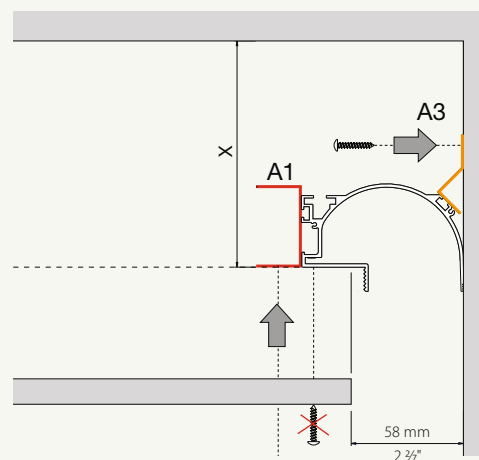
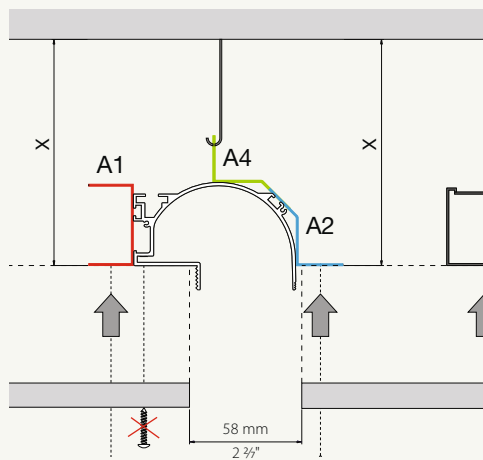
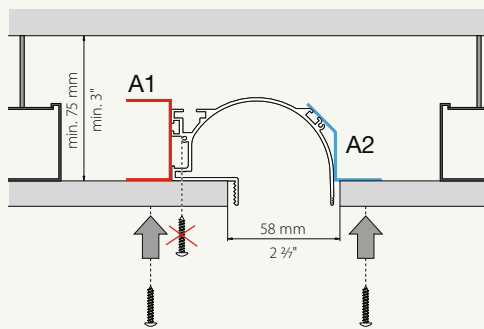
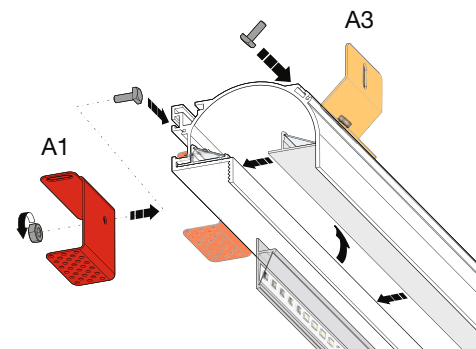
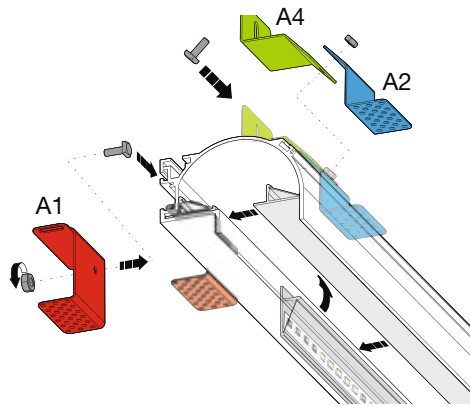
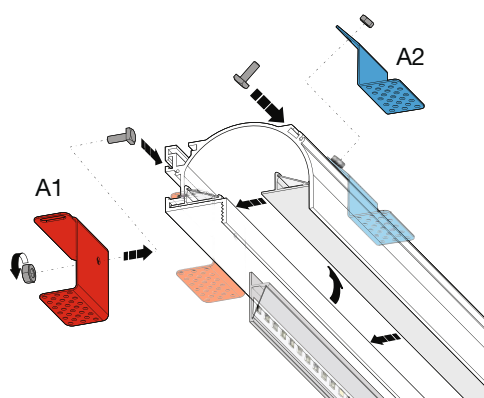

Esempio installazione a soffitto con **cartongesso già installato** (solo ed esclusivamente per segmenti rettilinei senza angoli)

An example of a ceiling installation with **false ceiling already installed** (exclusively for straight segments without corners)

Esempio installazione a soffitto con **cartongesso non presente** (le distanze "X" tra soffitto e bordi inferiori della squadretta dell'apparecchio e del telaio del cartongesso devono essere uguali)

An example of ceiling installation **without false ceiling** (the distance "X" between the ceiling and the bottom of the bracket unit and the frame of the false ceiling must be the same)

Esempio installazione segmento filo parete con **cartongesso non presente** (le distanze "X" tra soffitto e bordi inferiori della squadretta dell'apparecchio e del telaio del cartongesso devono essere uguali; è necessario fissare le piastrine "A3" sulla parete)

An example of an installation using a segment flush to the wall **without false ceiling** (the distance "X" between the ceiling and the bottom of the bracket unit and the frame of the false ceiling must be the same; it is necessary to fix the plates "A3" to the wall)

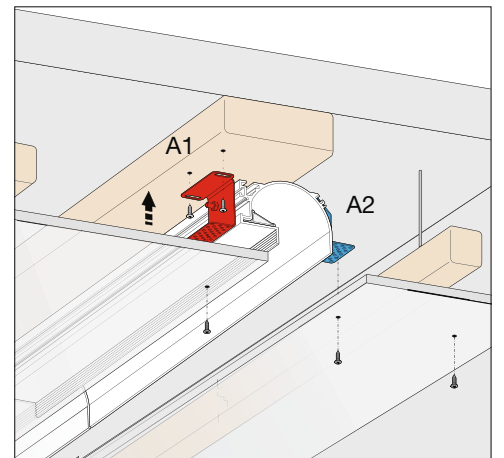
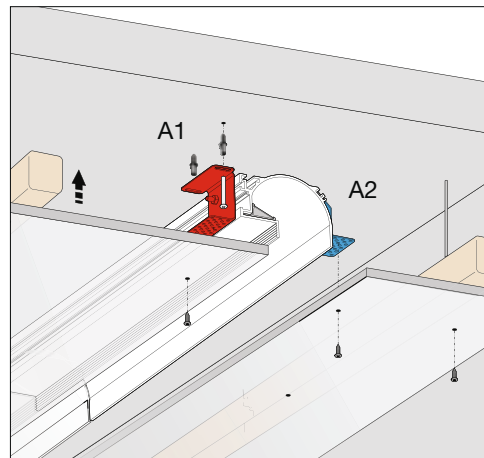
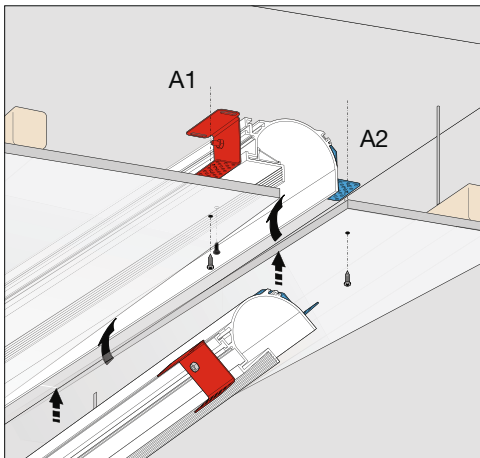
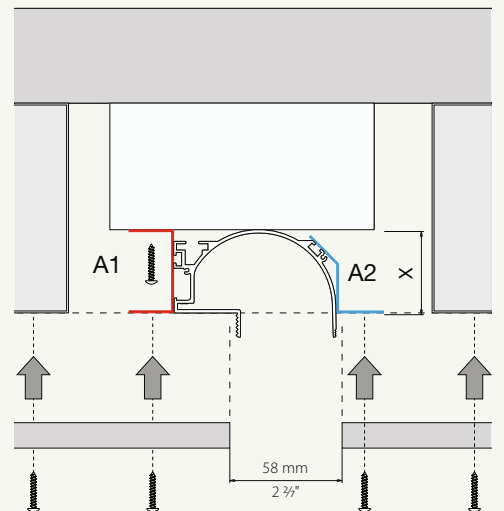
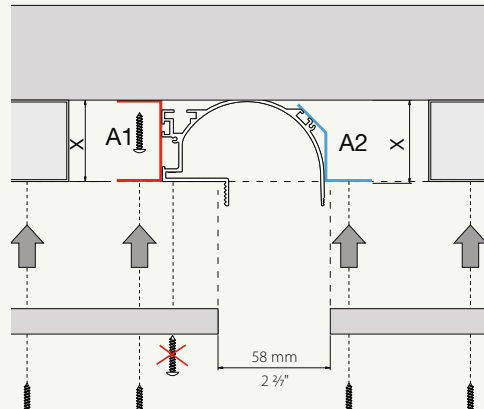
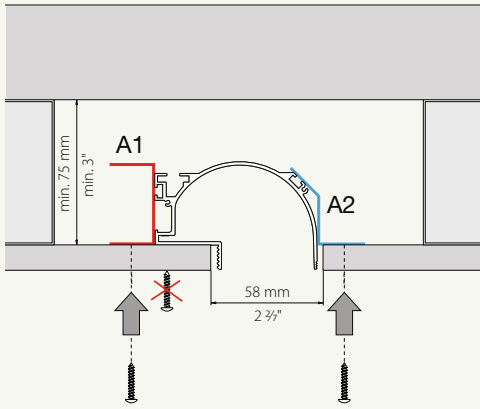
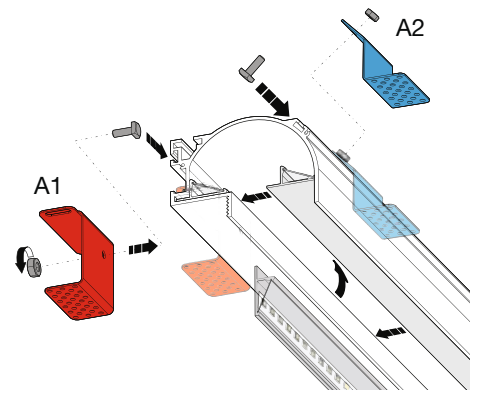
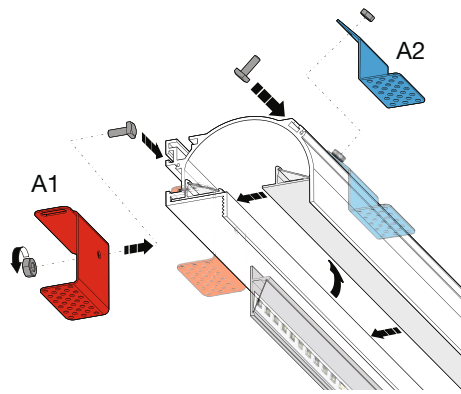
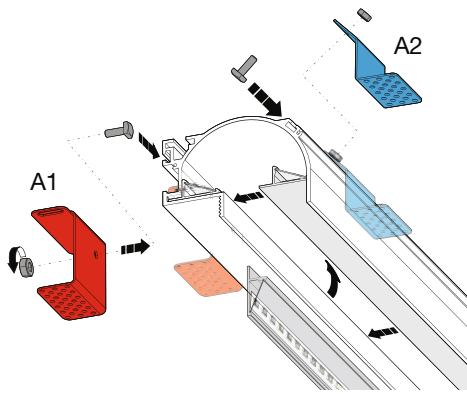

Esempio installazione a parete con cartongesso già installato (solo ed esclusivamente per segmenti rettilinei senza angoli)

An example of a wall installation with drywall already installed (exclusively for straight segments without corners)

Esempio installazione a parete con cartongesso non presente (le distanze "X" tra parete e bordi inferiori della squadretta dell'apparecchio e del telaio del cartongesso devono essere uguali)

An example of wall installation without drywall (the distance "X" between the ceiling and the bottom of the bracket unit and the frame of the false ceiling must be the same)

Esempio installazione a parete con cartongesso non presente (le distanze "X" tra parete e bordi inferiori della squadretta dell'apparecchio e del telaio del cartongesso devono essere uguali)

An example of wall installation without drywall (the distance "X" between the ceiling and the bottom of the bracket unit and the frame of the false ceiling must be the same)

CORNER

Made in Italy

Sistema modulare a soffitto o parete caratterizzato dal posizionamento arretrato della sorgente. L'installazione prevede l'ancoraggio alle superfici perimetrali e l'inserimento finale del pannello in cartongesso a filo con l'estruso, per un effetto di luce a scomparsa.

Modular LED system in extruded aluminum white painted, for wall or ceiling perimeter installation, characterized by the back positioning of the light source. The installation foresees the fixation of profiles to side surfaces and the final placing of plasterboard panel flush with the extruded body, to have a total recessed light effect.



CORNER

XG2045

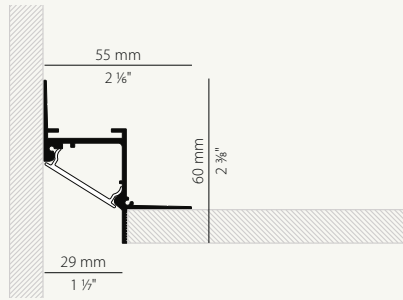

Electric options page 518

Dimming 522-523

Technical information 526

Wiring diagram 1-2 526

CORNER

LED CE IP40 IP20

PROFILE	CODICE / CODE	L MM	L INCHES		
Diffusore policarbonato incluso <input type="checkbox"/> Polycarbonate diffuser included	XG2045-50 TRACK	510	20"		 2150lm/mt
	XG2045-100 TRACK	1010	40"		
	XG2045-200 TRACK	2010	79 1/8"		
	XG2045-300 TRACK	3010	118 1/2"		
LED MODULE	XM001.050.0110	500	19 2/3"	125 mm	LED 3200lm/mt 8,5W 3000K Ra80 24V 28 LED 1075lm
	XM001.012.0110	125	5"		2,1W 3000K Ra80 24V 7 LED 268lm
	XM004.050.0110	500	19 2/3"	100 mm	12W 3000K Ra80 24V 35 LED 1600lm
	XM004.010.0110	100	4"		2,4W 3000K Ra80 24V 7 LED 320lm

Disponibili anche rotte LED. Vedi pagina 519 electric options.
Matrice di compatibilità LED Profile Matrix pagina 488
Also available LED rolls see page 519 electric options.
LED Profile Matrix page 488

STRIP ROLL 1 ROW
STRIP ROLL 1 ROW HE/N
STRIP ROLL 1 ROW HD
STRIP ROLL 1 ROW HF

Per alimentatori vedi pagina 522 electric options
For power supplies see on page 522 electric options

• UGR < 19 in funzione delle condizioni di installazione
UGR < 19 depending on installation conditions

Fotometrie e Classi Energetiche disponibili www.panzeri.it
Photometric data and Energy Label available at www.panzeri.it

XM2045-U90 1

Angolo 1 piano 90° parete-parete/soffitto-soffitto misure esterne 64x64mm
Angle 1 horizontal 90° wall-wall/ceiling-ceiling, external measurements 64x64mm

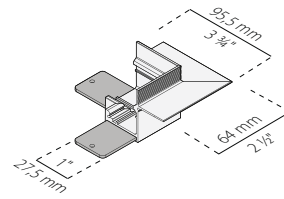

Vista laterale / Side view

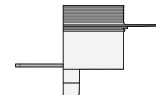

Vista inferiore / Bottom view

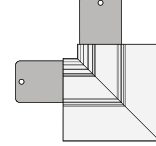

XM2045-U90 2

Angolo 2 piano 90° parete-parete/soffitto-soffitto misure esterne 64x64mm
Angle 2 horizontal 90° wall-wall/ceiling-ceiling, external measurements 64x64mm

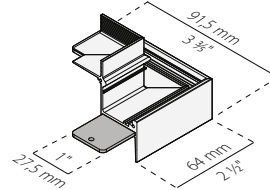

Vista laterale / Side view

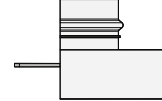

Vista inferiore / Bottom view

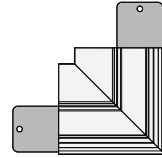

XM2045-ANG 3

Angolo 3 verticale 90° parete-soffitto/parete-parete misure esterne 64x64mm
Angle 3 vertical 90° wall-ceiling/wall-wall, external measurements 64x64mm

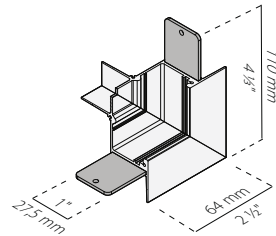

Vista laterale / Side view

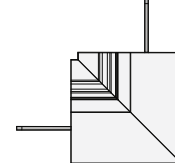

Vista inferiore / Bottom view

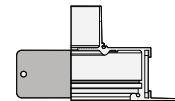

XM2045-ANG 4

Angolo 4 orizzontale 90° parete-parete misure esterne 64x64mm
Angle 4 horizontal 90° wall-wall, external measurements 64x64mm

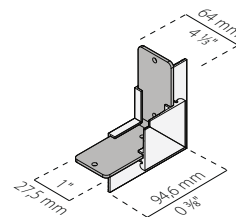

Vista laterale / Side view

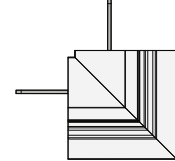

Vista inferiore / Bottom view

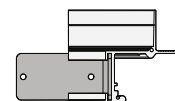

XM2045-U

Giunzione lineare
Linear junction

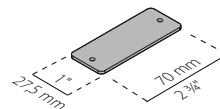

XM2045-T

Coppia di elementi terminali con viti
Pair of end segments with screws

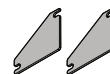

XM2045-U
Giunzione lineare
Linear junction

XM2045-U90 1
Angolo 1 piano 90° parete-parete / soffitto-soffitto misure esterne 64x64mm
Angle 1 horizontal 90° wall-wall / ceiling-ceiling, external measurements 64x64mm

XM2045-U90 2
Angolo 2 piano 90° parete-parete / soffitto-soffitto misure esterne 64x64mm
Angle 2 horizontal 90° wall-wall / ceiling-ceiling, external measurements 64x64mm

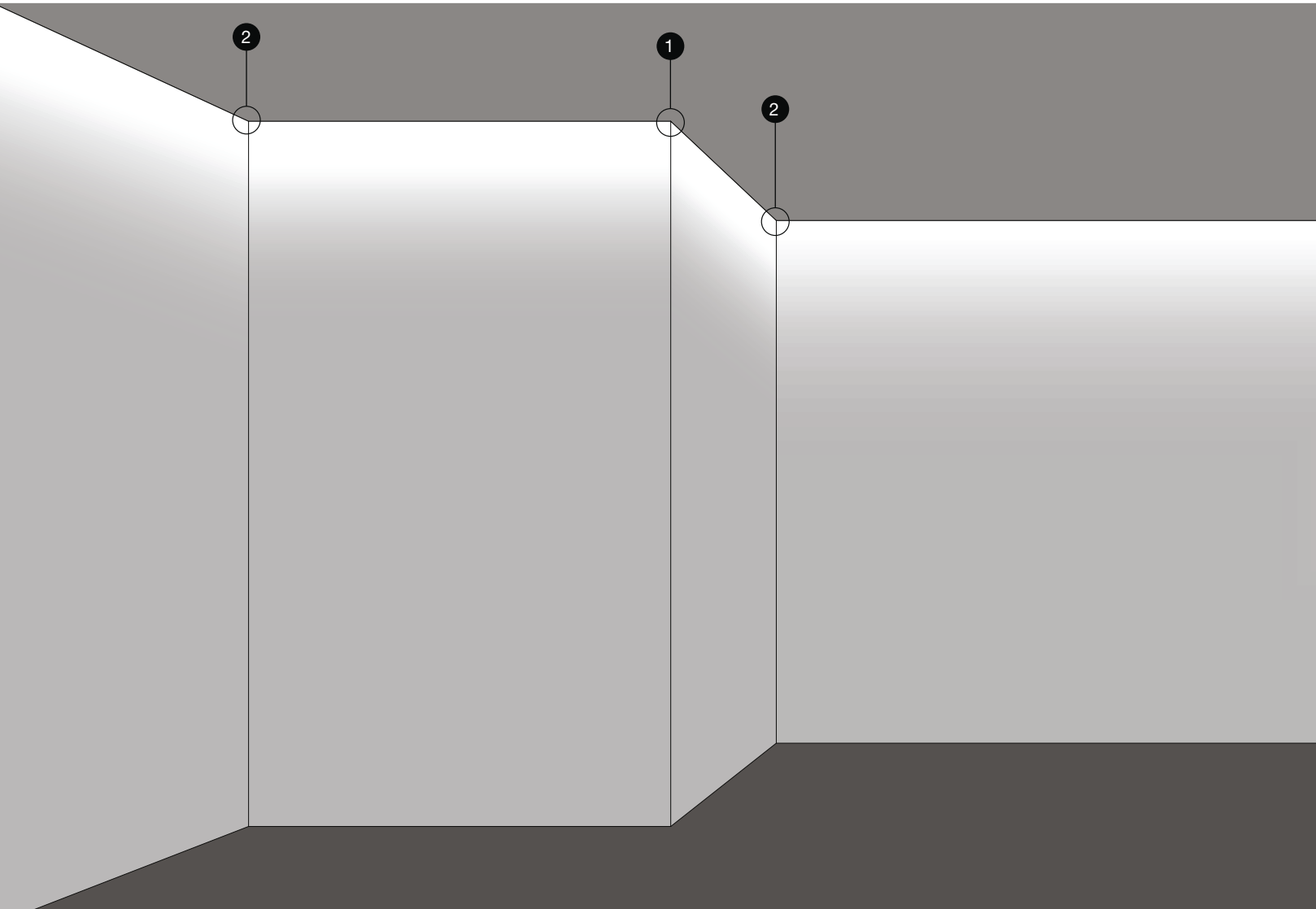
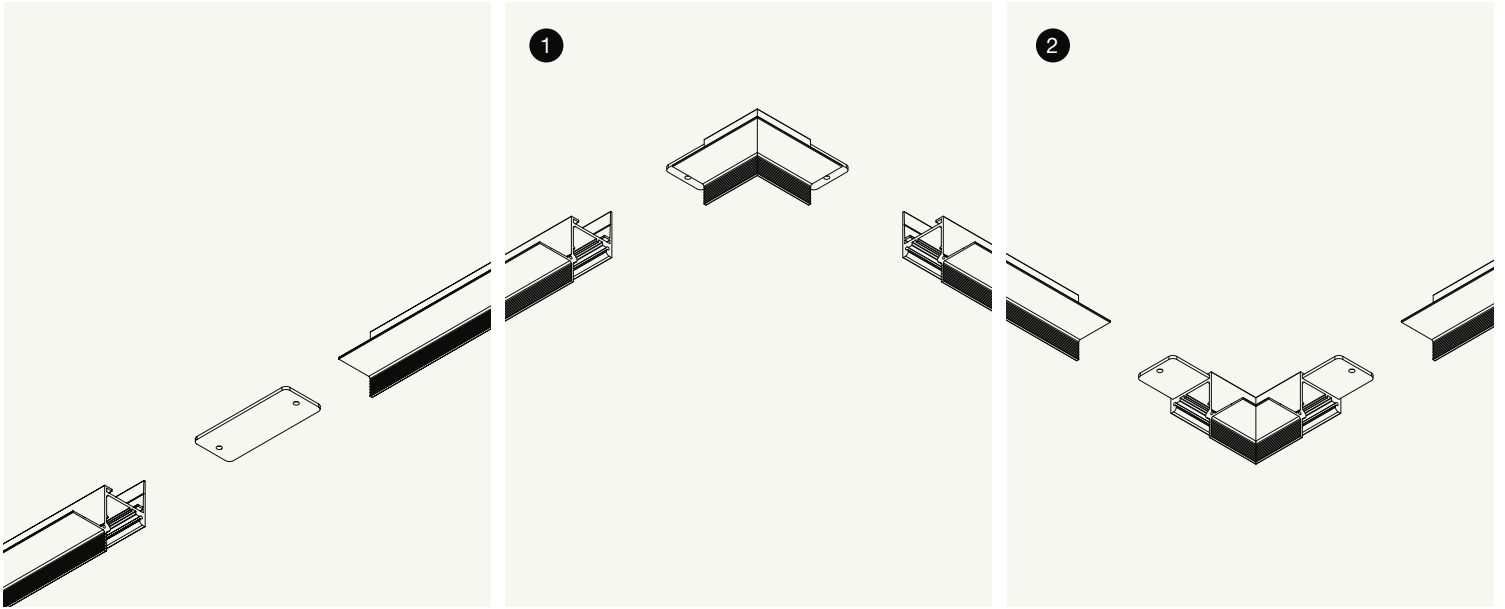

XM2045-ANG 3

Angolo 3 verticale 90° parete-soffitto/parete-parete misure esterne 64x64mm

Angle 3 vertical 90° wall-ceiling / wall-wall, external measurements 64x64mm

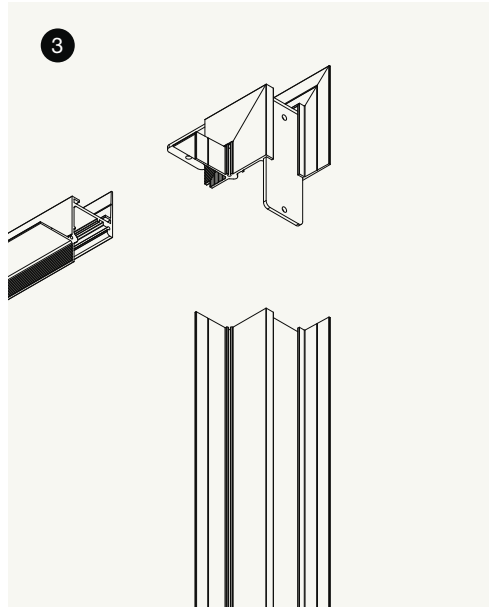

XM2045-ANG 4

Angolo 4 orizzontale 90° parete-parete misure esterne 64x64mm

Angle 4 horizontal 90° wall-wall, external measurements 64x64mm

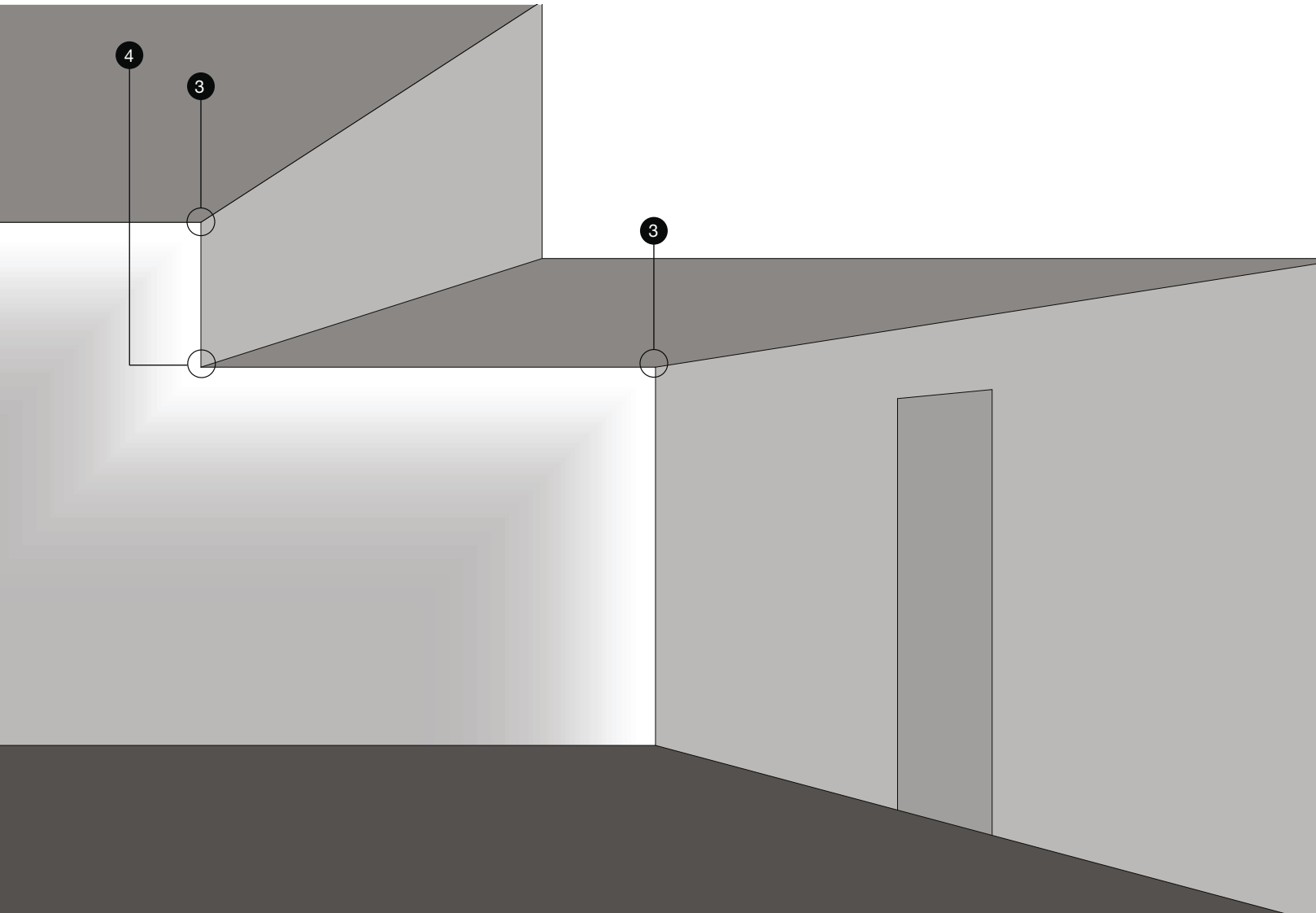
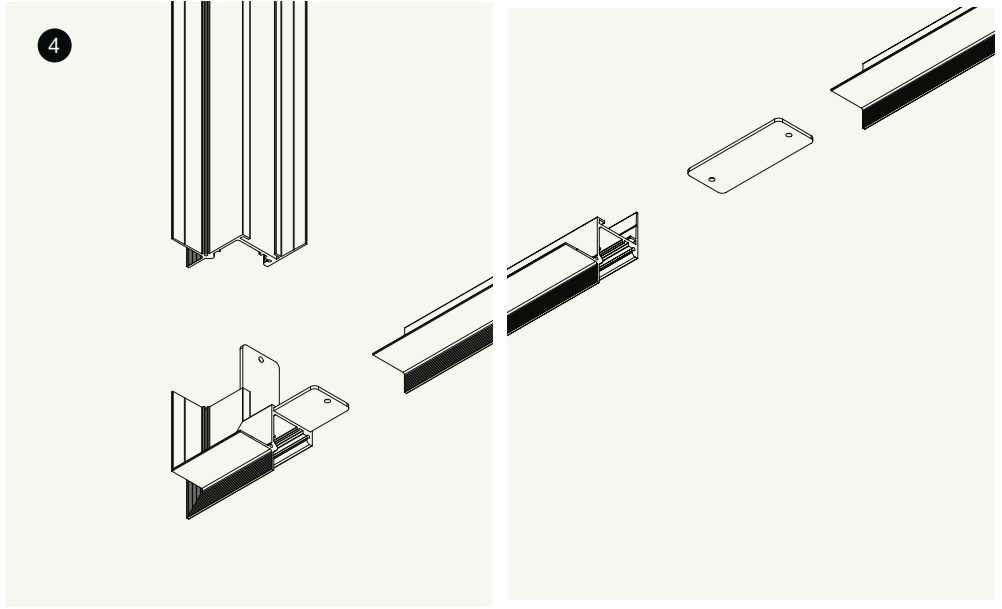

GIANO

Made in Italy

Sistema modulare in alluminio estruso disponibile in versione sospensione o parete. Sorgente luminosa composta da modulo LED a luce diretta e indiretta e driver ON/OFF con accensione separata o DALI / PUSH DIM integrato all'interno del profilo. Finitura con vernice poliaccrilica in bianco o nero e finitura frontale del profilo liscia. Schermo in policarbonato estruso opale o microprismatico. Ideale per uffici, corridoi, scale.

Modular extruded aluminum wall and suspension system. Light source made of LED module with direct and indirect light and separate switching ON/OFF or DALI / PUSH DIM integrated drivers. Finish in polyacrylic paint in white or black and smooth front finish of the profile. Diffuser in opal or micro prismatic polycarbonate. Ideal for offices, corridors, stairways.







GIANO

XP246

(XP246+XM002.050.0110+XM246T+KIT ALIM.)

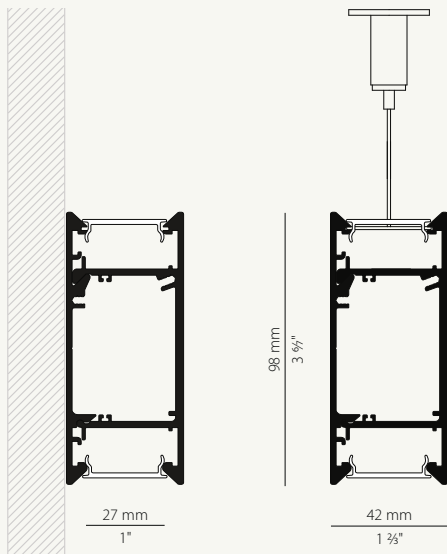

Electric options	page 518
Technical information	526
Wiring diagram 1-2	526

GIANO

LED CE IP40 850°

	CODICE / CODE	L MM	L INCHES			
Due schermi opali inclusi Two opal diffusers included	XP246__050.0099	515	20 3/4"			
	XP246__100.0099	1015	40"			
	XP246__200.0099	2015	79 1/2"			
	XP246__300.0099	3015	118 3/4"			
	XM002.050.0110	500	19 3/4"	✂ 72 mm	3040lm/mt	12W 3000K Ra80 24V 49 LED 1520lm
	XM002.007.0110	72	2 7/8"			1,7W 3000K Ra80 24V 7 LED 217lm



CODICI COLORI DISPONIBILI / COLOUR CODES AVAILABLE

46 Bianco + diffusori opali White + opal diffusers	48 Nero + diffusori opali Black + opal diffusers
--	--

Disponibili anche rotte LED vedi pagina 519 electric options.
Matrice di compatibilità LED Profile Matrix pagina 488
Also available LED rolls see page 519 electric options.
LED Profile Matrix page 488

STRIP ROLL 1 ROW HD STRIP ROLL 1 ROW HF

• UGR < 19 in funzione delle condizioni di installazione
UGR < 19 depending on installation conditions

Fotometrie e Classi Energetiche disponibili www.panzeri.it
Photometric data and Energy Label available at www.panzeri.it

XM246-U

Kit giunzione lineare / Kit of linear junctions

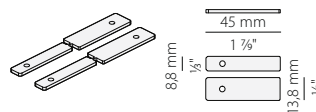

XM2033/34/45/46-600S

Diffusore in policarbonato opalite mm 6000 / Opal polycarbonate diffuser mm 6000

Only for project not for stock

XM2033/34/45/46-900S

Diffusore in policarbonato opale mm 9000 / Opal polycarbonate diffuser mm 9000

Only for project not for stock

XM2033/34/45/46-1200S

Diffusore in policarbonato opale mm 12000 / Opal polycarbonate diffuser mm 12000

Only for project not for stock

XM2033/34/45/46-600S PR

Diffusore in policarbonato microprismato mm 6000 / Polycarbonate microprismatic diffuser mm 6000

Only for project not for stock

XM2033/34/45/46-900S PR

Diffusore in policarbonato microprismato mm 9000 / Polycarbonate microprismatic diffuser mm 9000

Only for project not for stock

XM2033/34/45/46-1200S PR

Diffusore in policarbonato microprismato mm 12000 / Polycarbonate microprismatic diffuser mm 12000

Only for project not for stock

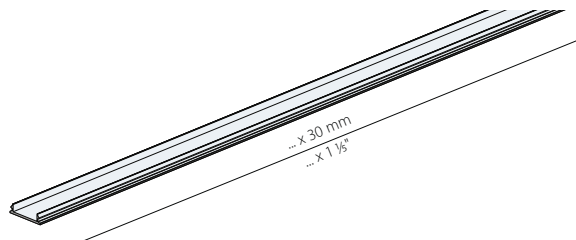

XM246-01T Bianco/White / XM246-02T Nero/Black

Coppia elementi terminali con viti / Pair of end segments with screws



XM2038/46-3

Kit di alimentazione 3 poli + cavo lunghezza cm 220. Rosone bianco
Power Supply Kit with 3-pole cable cm 220 lenght. White canopy

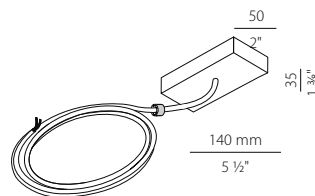

XM2038/46-5

Kit di alimentazione 5 poli + cavo lunghezza cm 220. Rosone bianco
Power Supply Kit with 5-pole cable cm 220 lenght. White canopy

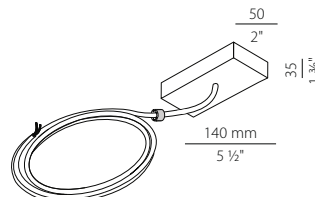

XM246-01-KIT-S Bianco/White / XM246-02-KIT-S Nero/Black

Coppia kit sospensione per estremità / Couple of side suspension kit

XM246-01-KIT-S1 Bianco/White / XM246-02-KIT-S1 Nero/Black

Singolo kit sospensione inframezzo / Single middle suspension kit



XM30/24I V in 220-240V AC out 24V DC W 5-30 λ 090

Kit alimentazione interna / Power supply kit

XM60/24I V in 220-240V AC out 24V DC W 20-60 λ 090

Kit alimentazione interna / Power supply kit

XM150/24I V in 220-240V AC out 24V DC W 150 λ 096

Kit alimentazione interna / Power supply kit

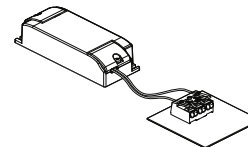

XM35/24I DIM V in 220-240V AC out 24V DC W 35 λ 090

Kit alimentazione DALI / PUSH DIM interna / DALI / PUSH DIM power supply kit

XM60/24I DIM V in 220-240V AC out 24V DC W 60 λ 090

Kit alimentazione DALI / PUSH DIM interna / DALI / PUSH DIM power supply kit

XM100/24I DIM V in 220-240V AC out 24V DC W 100 λ 096

Kit alimentazione DALI / PUSH DIM interna / DALI / PUSH DIM power supply kit

XM150/24I DIM V in 220-240V AC out 24V DC W 150 λ 096

Kit alimentazione DALI / PUSH DIM interna / DALI / PUSH DIM power supply kit

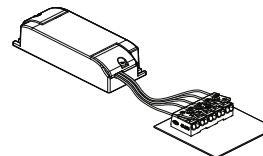

DRIVER MATRIX XP246

CODE	KIT ALIMENTAZIONE INTERNA POWER SUPPLY KIT	KIT ALIMENTAZIONE DALI / PUSH DIM INTERNA DALI / PUSH DIM POWER SUPPLY KIT
XP24646.050.0099	1x XM30/24I	1x XM35/24I DIM
XP24646.100.0099	1x XM60/24I	1x XM60/24I DIM
XP24646.200.0099	1x XM150/24I	1x XM100/24I DIM
XP24646.300.0099	1x XM150/24I	1x XM150/24I DIM

VADEMECUM PROFILI / PROFILE HANDBOOK

FATTIBILITÀ GIUNZIONI / AVAILABLE JOINTS						
ITEM	GIUNZIONE / JUNCTION					
	LINEARE/LINEAR	90°	T	X	ANG. VERTICALI/VERTICAL ANGLE	SPECIALI / SPECIAL
XG247	●	●				
XG231/XG232	●					
XG2033	●	●	●	●	●	●
XG2034	●	●			●	
XP2033	●	●				
XG2047						
XP2048						
XG2038	●	●	●*	●*	●	60/120
XG2039	●	●			●	
XP2038	●	●	●*	●*		
XG2044	●	●			●	
XG2045	●	●			●	
XP246	●					

●* Solo versione ON/OFF / ON/OFF version only

MATRICE LED/PROFILO / LED PROFILE MATRIX												
ITEM	XM001	XM002	XM003	XM004	XM005	XM1ROW	XM1 ROW SNAKE	XM1ROW HD	XM1ROW HF	XM1ROW/N	XM1ROW HE/N	XM1ROW HO
XG247					●							
XG231/XG232			●				●					
XG2033	●			●		●	●	●	●	●	●	
XG2034	●			●		●		●	●	●	●	
XP2033	●			●		●		●	●	●	●	
XG2047								●	●			
XP2048								●	●			
XG2038												
XG2039												
XP2038												
XG2044								●	●			●
XG2045	●			●		●		●	●	●	●	
XP246		●						●	●			

INFO LED						
LED	POTENZA / POWER (W/m)	LUMEN (lm/m)	✂ (mm)	LED MT	LUNGHEZZA / LENGHT (mm)	
XM001	17	2150	125	56	500/125	
XM002	24	3040	72	98	500/72	
XM004	24	3200	100	70	500/100	
XM005	17,2	2860	62,5	128	500/125	
XM1ROW	9,6	1100	50	120	5000	
XM1ROW SNAKE	14,4	1080	100	60	5000	
XM1ROW HD	17	1964	42	168	5000	
XM1ROW HF	10	1200	42	168	5000	
XM1ROW/N	14,4	1080	100	60	5000	
XM1ROW HE/N	24	2000	50	120	5000	
XM1ROW HO	35	2833	35	168	3000	

DIMENSIONI E POSSIBILITÀ DI TAGLIO / DIMENSION AND CUT					
ITEM	DIMENSIONI STANDARD / STANDARD DIMENSIONS				TAGLIABILE / CUTTABLE
XG247	510	1010	2010	3010	●
XG2033	510	1010	2010	3010	●
XG2034	510	1010	2010	3010	●
XP2033	525	1025	2025	3025	●
XG2047	2000				●
XP2048	2000				●
XG2038	591	891	1191	1491	XG2038-60 TRACK JOLLY
XG2039	591	891	1191	1491	XG2039-60 TRACK JOLLY
XP2038	591	891	1191	1491	
XG2044	420	920	1920	2920	●
XG2045	510	1010	2010	3010	●
XP246	515	1015	2015	3015	●

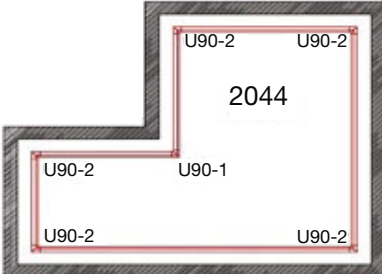
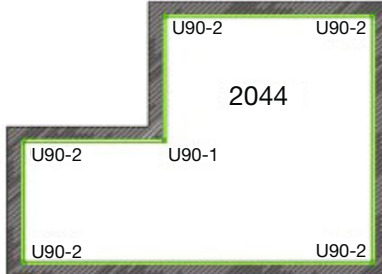
ANGOLI / ANGLE U90-1/U90-2	
	<p>La luce nella configurazione standard è sempre rivolta verso la parete</p> <p>With standard configuration light is always directed towards the wall</p>
	<p>La luce nella configurazione standard è sempre rivolta verso la parete</p> <p>With standard configuration light is always directed towards the wall</p>

INVISIBILI

494 **CLICK CLACK**
496 **XGQ0998**
497 **XGQ0998GL**
498 **XGQ0999**
498 **XGQ1000-1**
499 **XGQ1004**
500 **XGQ1004-45**
499 **XGQ1004-GL**
500 **XGQ1015**
501 **XGQ1019**
504 **XGQ1025**
504 **XGQ1026**
505 **XGQ1031**
507 **XGQ1032**
506 **XGQ1034-1**
506 **XGQ1034-2**
507 **XGQ1034-3**
508 **XGQ1210**
509 **XGQ1211**
496 **XGR0997**
501 **XGR1020**
502 **XGR1021**
503 **XGR1023**
503 **XGR1024**
505 **XGR1027**

PURE™
WHITE

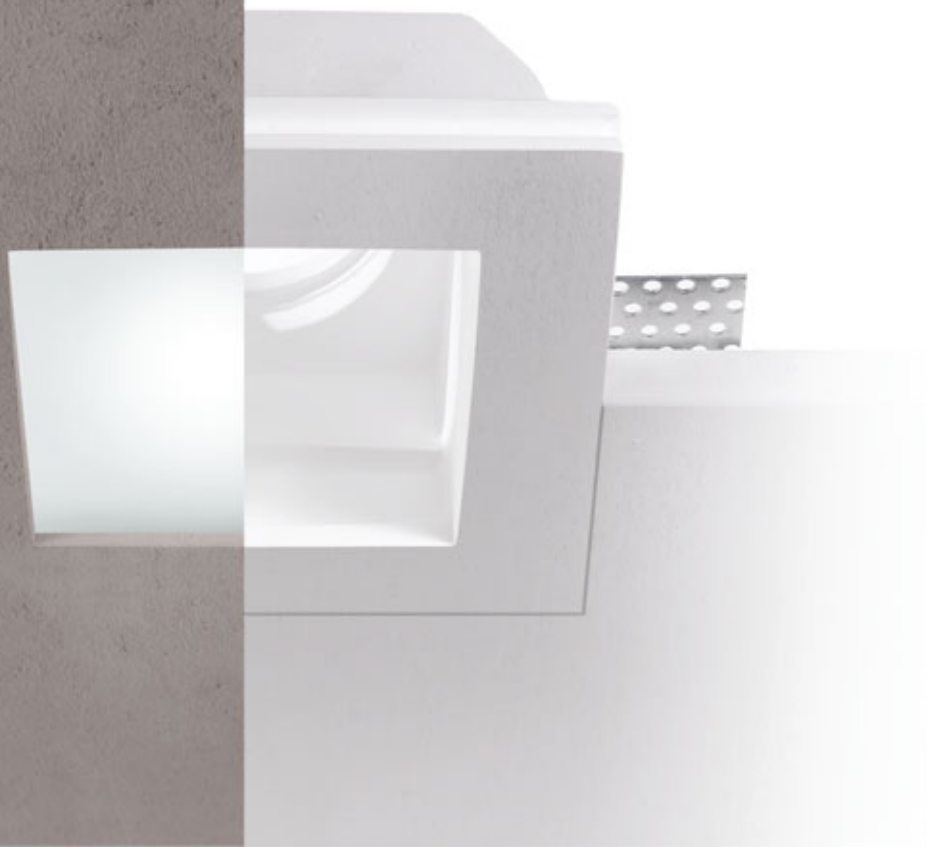

PUREZZA ED ESSENZIALITÀ NATURALI

Il passato è rappresentato da un prodotto tradizionale: un elemento in gesso, esistente già da diversi anni nel settore dell'illuminazione architettonica. Un prodotto sempre più diffuso perché semplice, facile da installare e di grande impatto estetico. Il presente è la creazione della collezione INVISIBILI; un progetto innovativo che, partendo da un prodotto esistente, lo scompone, lo ripensa per poi ridisegnarlo secondo le più moderne tecnologie e per meglio adattarlo alle nuove esigenze abitative. Nel mezzo la filosofia di Panzeri che, avendo maturato nel tempo una profonda "cultura del progetto", non si accontenta di replicare un oggetto, magari dandogli una forma nuova, ma accetta la sfida di reinventarlo completamente. Ed è proprio da questo amore per la ricerca e l'innovazione che

nascono gli INVISIBILI, una completa linea di elementi in gesso realizzati con materiali assolutamente naturali e riprogettati sotto tutti i punti di vista. Una linea di prodotti che rappresenta la massima espressione della filosofia PUREWHITE di Panzeri. PURE: puro come il materiale utilizzato: il gesso. Semplice, naturale ed ecocompatibile, atossico sia per l'uomo sia per l'ambiente e, soprattutto, testato secondo le più severe norme tecniche in vigore e certificato dai più prestigiosi e autorevoli istituti europei. WHITE: bianco come una lieve pennellata di luce che trasforma ogni superficie in un'affascinante opera d'arte contemporanea. La luce si fa materia e la materia luce, liberandosi da ogni supporto visibile.

Arch. Massimo Rosati



NATURAL SIMPLICITY AND PURITY

The past is represented by a traditional product: an element in plaster, which has existed for many years in the field of architectural lighting. INVISIBILI is an increasingly popular product because of its innate simplicity, its easy installation and its great aesthetic impact. The present is the creation of the innovative collection INVISIBILI, which originated from an existing product. The design was dismantled, rethought and then redesigned using the latest technologies and adapted to new housing needs. At the heart of the philosophy of Panzeri there is a profound sense of "design" culture: it is not sufficient to replicate an object, perhaps giving it a new form; instead Panzeri accept the challenge to reinvent the product completely. It is from this love

of research and innovation that INVISIBILI was created - a complete range of items made of plaster with natural materials and redesigned in all its aspects. A product range that represents the ultimate expression of the philosophy of PUREWHITE™ by Panzeri. PURE: pure as the material used, chalk. Simple, natural and environmentally friendly, non-toxic for humans and the environment and, most importantly, tested according to the most stringent technical standards and certified by the most prestigious and influential institutions in Europe. WHITE: white as a narrow ray of light that transforms any surface into an attractive piece of contemporary art. Light becomes matter and matter light, freed from any visible support.

Arch. Massimo Rosati



In cinque mosse: prendi la misura, taglia, inserisci, avvita e stucca. Un sistema di illuminazione a scomparsa totale.

In five moves: take measurements, cut, insert, screw and plaster. A completely invisible lighting system.

INVIS

Per ogni articolo quadrato a catalogo (XGQ) sono disponibili opportune casseforme per laterizio/calcestruzzo con microregolazione per allineamento.

For every square item in the catalogue (XGQ), brick/concrete housings with micro-adjustment for alignment are available.

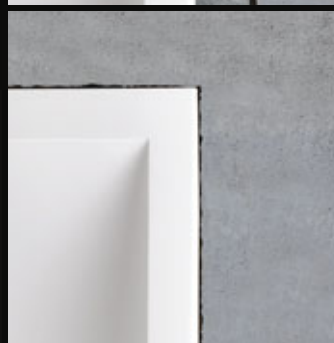
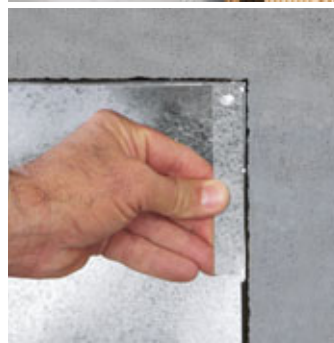
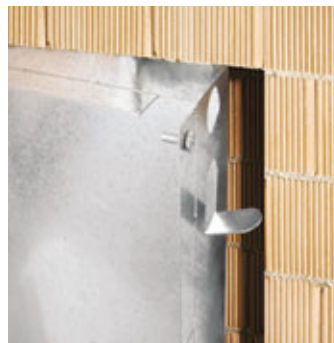

PURE™
WHITE

BUILD



Click clack è un incasso in gesso con un foro di 35mm. Garantisce massima funzionalità grazie ad uno speciale meccanismo push&pull che consente il ribassamento del portalamпада per la sostituzione della sorgente luminosa, evitando invasivi interventi di manutenzione.

Click clack is a plaster recessed with a 35mm hole. It guarantees maximum functionality thanks to a special push & pull mechanism that allows the lamp holder to be lowered to replace the light source, avoiding invasive maintenance operations.



CLICK CLACK

XGR1212

XM3 lampholder + terminal block
 4W GU10 Ø 35 mm 3000K Ra80 330lm 110-240V 
 Not dimmable
 CE IP20 

+ Electric options

(see details on page 518)

XM5/GU10-35 retrofit led lamp

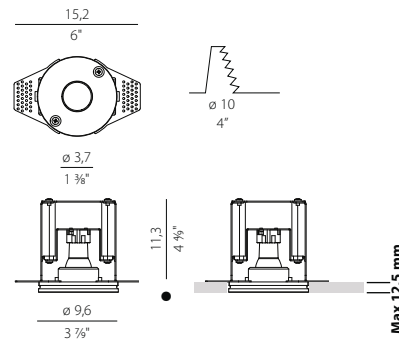

NOVELTY

- Minima altezza di ingombro dell'apparecchio (le quote minime del vano di incasso sono riportate sul foglio di istruzioni)

Minimum height of the appliance (see the minimum values for housing compartment in the instruction sheets)

Lampadina non inclusa, vedi electric options.
 Da acquistare separatamente.

Bulb not included, see electric options.
 Please purchase separately.

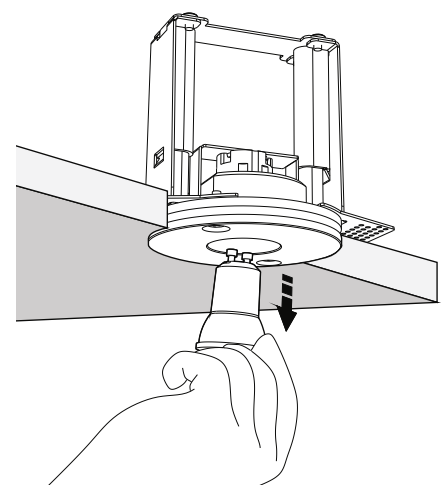
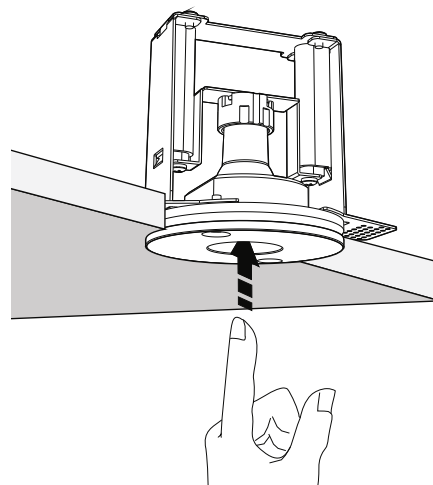



Incasso in gesso fisso Fixed plaster recessed



Example of bulb

XGR0997

XM3 lampholder + terminal block

Max 50W GU10

CE IP20

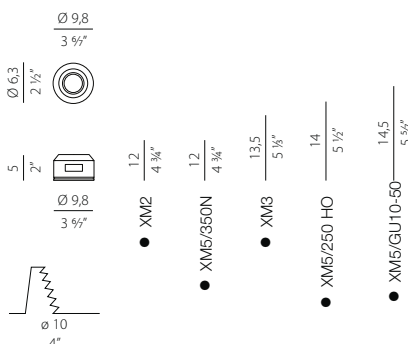

+ Electric options

(see details on page 518)

XM2 lampholder + terminal block
XM5/GU10-50 retrofit led lamp
XM5/350N LED
XM5/250 HO LED
XM6/350/15 DRIVER
XM6/250/10 DRIVER
XM6-20 D/P MULTI DRIVER ★
XM6-25 D/P MULTI DRIVER

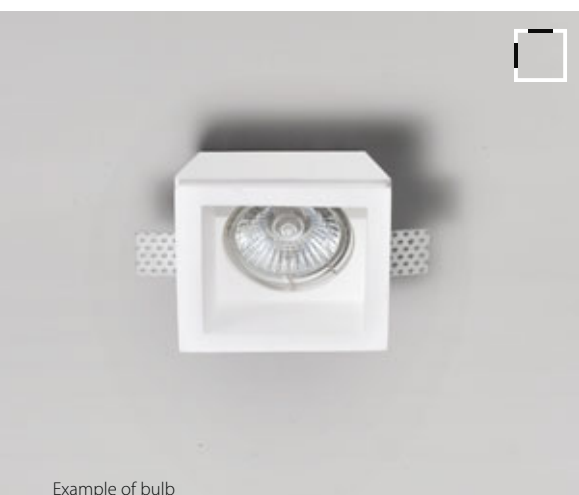

Example of bulb

XGQ0998

XM3 lampholder + terminal block

Max 50W GU10

CE IP20

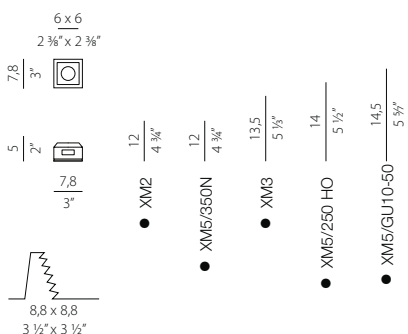

+ Electric options

(see details on page 518)

XM2 lampholder + terminal block
XM5/GU10-50 retrofit led lamp
XM5/350N LED
XM5/250 HO LED
XM6/350/15 DRIVER
XM6/250/10 DRIVER
XM6-20 D/P MULTI DRIVER ★
XM6-25 D/P MULTI DRIVER

XM0998

85x85x155 mm

Cassaforma per laterizio / calcestruzzo con microregolazione per allineamento. **Gruppo di alimentazione da prevedere remoto esternamente alla cassaforma.**

Brick/concrete housing with micro-adjustment for alignment. **Electrical power supply must be remote outside of the housing.**

I prodotti sono venduti con alimentazione di serie GU10. Le elettrificazioni opzionali (XM2, XM5/GU10-50, XM5/350N, XM5/250 HO) e gli Optionals (XM6/350/15, XM6/250/10, XM6-20 D/P MULTI, XM6-25 D/P MULTI) sono forniti separatamente al prodotto e vanno perciò sostituiti a quelli di serie.

The products are sold with GU10 fittings. Different types of electricity supply (XM2, XM5/GU10-50, XM5/350N, XM5/250 HO) and the Optionals (XM6/350/15, XM6/250/10, XM6-20 D/P MULTI, XM6-25 D/P MULTI) substitute the series fitting.

- Minima altezza di ingombro dell'apparecchio (le quote minime del vano di incasso sono riportate sul foglio di istruzioni)

Minimum height of the appliance (see the minimum values for housing compartment in the instruction sheets)

- ★ Dimensione dell'alimentatore maggiore del foro d'incasso, dunque installare l'alimentatore in apposito vano d'ispezione.

Power supply unit is larger than the recess hole, install the power supply unit in a special inspection compartment.

Incasso in gesso fisso Fixed plaster recessed



XGQ0998-GL

XM3 lampholder + terminal block

Max 50W GU10 

CE IP20 

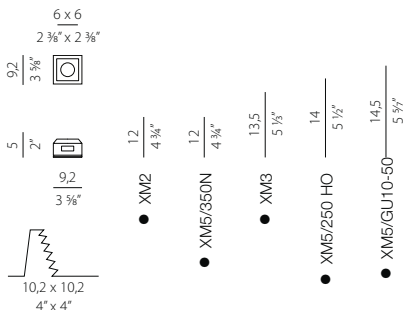

+ Electric options

(see details on page 518)

XM2 lampholder + terminal block

XM5/GU10-50 retrofit led lamp

XM5/350N LED

XM5/250 HO LED

XM6/350/15 DRIVER

XM6/250/10 DRIVER

XM6-20 D/P MULTI DRIVER *

XM6-25 D/P MULTI DRIVER

Con vetro

With glass

XM0998GL

95x95x155 mm

Cassaforma per laterizio / calcestruzzo con microregolazione per allineamento.

Gruppo di alimentazione da prevedere remoto esternamente alla cassaforma.

Brick/concrete housing with micro-adjustment for alignment.

Electrical power supply must be remote outside of the housing.

I prodotti sono venduti con alimentazione di serie GU10. Le elettrificazioni opzionali (XM2, XM5/GU10-50, XM5/350N, XM5/250 HO) e gli Optionals (XM6/350/15, XM6/250/10, XM6-20 D/P MULTI, XM6-25 D/P MULTI) sono forniti separatamente al prodotto e vanno perciò sostituiti a quelli di serie.

The products are sold with GU10 fittings. Different types of electricity supply (XM2, XM5/GU10-50, XM5/350N, XM5/250 HO) and the Optionals (XM6/350/15, XM6/250/10, XM6-20 D/P MULTI, XM6-25 D/P MULTI) substitute the series fitting.

- Minima altezza di ingombro dell'apparecchio (le quote minime del vano di incasso sono riportate sul foglio di istruzioni)
- * Dimensione dell'alimentatore maggiore del foro d'incasso, dunque installare l'alimentatore in apposito vano d'ispezione.

Minimum height of the appliance (see the minimum values for housing compartment in the instruction sheets)

Power supply unit is larger than the recess hole, install the power supply unit in a special inspection compartment.

Fotometrie e Classi Energetiche disponibili www.panzeri.it
Photometric data and Energy Label available at www.panzeri.it

Incasso in gesso completo di faretto orientabile in metallo bianco
Plaster recessed with adjustable metal white spot



Example of bulb

XGQ0999

Max 75W G53 12V QR111
 CE IP20

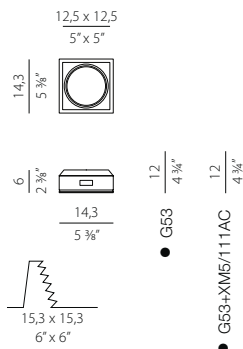

+ Electric options
 (see details on page 518)

XM5/111AC
 22,5W 3000K 40° Ra83 220-240V 1850lm
 NOT DIMMABLE



Example of bulb

XM1000-1

XM3 lampholder + terminal block
 Max 50W GU10
 CE IP20

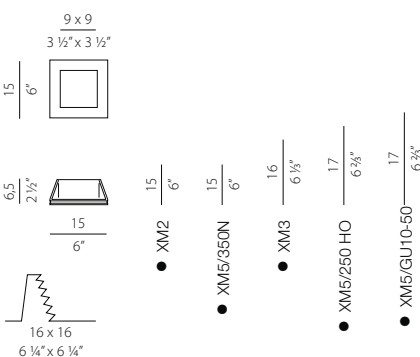

+ Electric options
 (see details on page 518)

XM2 lampholder + terminal block
 XM5/GU10-50 retrofit led lamp
 XM5/350N LED
 XM5/250 HO LED
 XM6/350/15 DRIVER
 XM6/250/10 DRIVER
 XM6-20 D/P MULTI DRIVER *
 XM6-25 D/P MULTI DRIVER

XM0999

153x153x155 mm

Cassaforma per laterizio / calcestruzzo con microregolazione per allineamento. **Gruppo di alimentazione da prevedere remoto esternamente alla cassaforma.**

XM1000-1

161x161x155 mm

Brick/concrete housing with micro-adjustment for alignment. **Electrical power supply must be remote outside of the housing.**

XGQ0999

I prodotti sono venduti con alimentazione di serie G53 (QR111). L'elettrificazione opzionale XM5/111AC è fornita separatamente al prodotto e va perciò sostituita a quella di serie.

The products are sold with G53 (QR111) fittings. XM5/111AC bulb is an optional and substitutes the series fitting.

XM1000-1

I prodotti sono venduti con alimentazione di serie GU10. Le elettrificazioni opzionali (XM2, XM5/GU10-50, XM5/350N, XM5/250 HO) e gli Optionals (XM6/350/15, XM6/250/10, XM6-20 D/P MULTI, XM6-25 D/P MULTI) sono forniti separatamente al prodotto e vanno perciò sostituiti a quelli di serie.

The products are sold with GU10 fittings. Different types of electricity supply (XM2, XM5/GU10-50, XM5/350N, XM5/250 HO) and the Optionals (XM6/350/15, XM6/250/10, XM6-20 D/P MULTI, XM6-25 D/P MULTI) substitute the series fitting.

- Minima altezza di ingombro dell'apparecchio (le quote minime del vano di incasso sono riportate sul foglio di istruzioni)

Minimum height of the appliance (see the minimum values for housing compartment in the instruction sheets)

Fotometrie e Classi Energetiche disponibili www.panzeri.it
 Photometric data and Energy Label available at www.panzeri.it

Incasso in gesso fisso Fixed plaster recessed



XGQ1004

XM3 lampholder + terminal block

Max 50W GU10

CE IP20

7 x 7
2 3/4" x 2 3/4"

11,5
4 1/2"

5
2"

11,5
4 1/2"

12,5 x 12,5
5" x 5"

11,5
4 1/2"

● XM2

12
4 3/4"

● XM5/350N

13,5
5 1/8"

● XM3

13,5
5 1/8"

● XM5/250 HO

14,5
5 7/8"

● XM5/GU10-50

+ Electric options

(see details on page 518)

XM2 lampholder + terminal block

XM5/GU10-50 retrofit led lamp

XM5/350N LED

XM5/250 HO LED

XM6/350/15 DRIVER

XM6/250/10 DRIVER

XM6-20 D/P MULTI DRIVER ★

XM6-25 D/P MULTI DRIVER



XGQ1004-GL

XM3 lampholder + terminal block

Max 50W GU10

CE IP20

7 x 7
2 3/4" x 2 3/4"

11,5
4 1/2"

6
2 3/8"

11,5
4 1/2"

12,5 x 12,5
5" x 5"

12
4 3/4"

● XM2

13
5 1/8"

● XM5/350N

14
5 1/2"

● XM3

14,5
5 7/8"

● XM5/GU10-50

15
6"

● XM5/250 HO

+ Electric options

(see details on page 518)

XM2 lampholder + terminal block

XM5/GU10-50 retrofit led lamp

XM5/350N LED

XM5/250 HO LED

XM6/350/15 DRIVER

XM6/250/10 DRIVER

XM6-20 D/P MULTI DRIVER ★

XM6-25 D/P MULTI DRIVER

Con vetro
With glass

XM1004 - XM1004-GL

125x125x155 mm

Cassaforma per laterizio / calcestruzzo con microregolazione per allineamento. **Gruppo di alimentazione da prevedere remoto esternamente alla cassaforma.**

Brick/concrete housing with micro-adjustment for alignment. **Electrical power supply must be remote outside of the housing.**

I prodotti sono venduti con alimentazione di serie GU10. Le elettrificazioni opzionali (XM2, XM5/GU10-50, XM5/350N, XM5/250 HO) e gli Optionals (XM6/350/15, XM6/250/10, XM6-20 D/P MULTI, XM6-25 D/P MULTI) sono forniti separatamente al prodotto e vanno perciò sostituiti a quelli di serie.

The products are sold with GU10 fittings. Different types of electricity supply (XM2, XM5/GU10-50, XM5/350N, XM5/250 HO) and the Optionals (XM6/350/15, XM6/250/10, XM6-20 D/P MULTI, XM6-25 D/P MULTI) substitute the series fitting.

- Minima altezza di ingombro dell'apparecchio (le quote minime del vano di incasso sono riportate sul foglio di istruzioni)

Minimum height of the appliance (see the minimum values for housing compartment in the instruction sheets)

- ★ Dimensione dell'alimentatore maggiore del foro d'incasso, dunque installare l'alimentatore in apposito vano d'ispezione.

Power supply unit is larger than the recess hole, install the power supply unit in a special inspection compartment.

Incasso in gesso fisso Fixed plaster recessed



Example of bulb

XGQ1019

XM3 lampholder + terminal block

Max 50W GU10

CE IP20

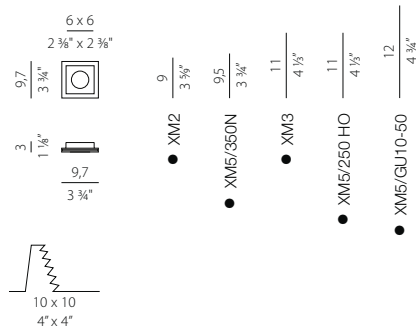

+ Electric options

(see details on page 518)

XM2 lampholder + terminal block
XM5/GU10-50 retrofit led lamp
XM5/350N LED
XM5/250 HO LED
XM6/350/15 DRIVER
XM6/250/10 DRIVER
XM6-20 D/P MULTI DRIVER ★
XM6-25 D/P MULTI DRIVER

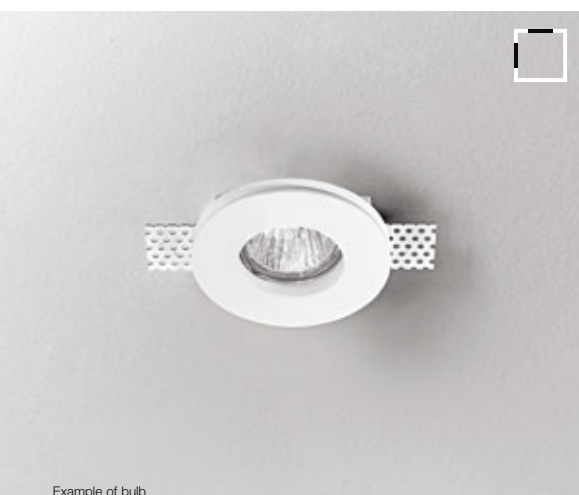

Example of bulb

XGR1020

XM3 lampholder + terminal block

Max 50W GU10

CE IP20

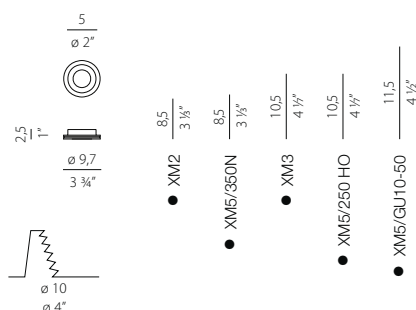

+ Electric options

(see details on page 518)

XM2 lampholder + terminal block
XM5/GU10-50 retrofit led lamp
XM5/350N LED
XM5/250 HO LED
XM6/350/15 DRIVER
XM6/250/10 DRIVER
XM6-20 D/P MULTI DRIVER ★
XM6-25 D/P MULTI DRIVER

XM1019

105x105x155 mm

Cassaforma per laterizio / calcestruzzo con microregolazione per allineamento. **Gruppo di alimentazione da prevedere remoto esternamente alla cassaforma.**

Brick/concrete housing with micro-adjustment for alignment. **Electrical power supply must be remote outside of the housing.**

I prodotti sono venduti con alimentazione di serie GU10. Le elettrificazioni opzionali (XM2, XM5/GU10-50, XM5/350N, XM5/250 HO) e gli Optionals (XM6/350/15, XM6/250/10, XM6-20 D/P MULTI, XM6-25 D/P MULTI) sono forniti separatamente al prodotto e vanno perciò sostituiti a quelli di serie.

The products are sold with GU10 fittings. Different types of electricity supply (XM2, XM5/GU10-50, XM5/350N, XM5/250 HO) and the Optionals (XM6/350/15, XM6/250/10, XM6-20 D/P MULTI, XM6-25 D/P MULTI) substitute the series fitting.

- Minima altezza di ingombro dell'apparecchio (le quote minime del vano di incasso sono riportate sul foglio di istruzioni)

Minimum height of the appliance (see the minimum values for housing compartment in the instruction sheets)

- ★ Dimensione dell'alimentatore maggiore del foro d'incasso, dunque installare l'alimentatore in apposito vano d'ispezione.

Power supply unit is larger than the recess hole, install the power supply unit in a special inspection compartment.

Incasso in gesso fisso Fixed plaster recessed

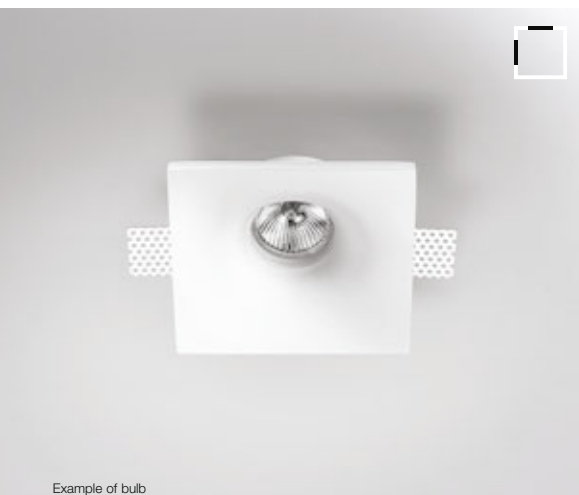

Example of bulb

XGR1021

XM3 lampholder + terminal block

Max 50W GU10

CE IP20

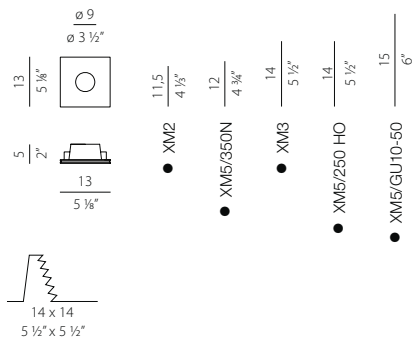

+ Electric options

(see details on page 518)

XM2 lampholder + terminal block

XM5/GU10-50 retrofit led lamp

XM5/350N LED

XM5/250 HO LED

XM6/350/15 DRIVER

XM6/250/10 DRIVER

XM6-20 D/P MULTI DRIVER *

XM6-25 D/P MULTI DRIVER

Fisso

Fixed

REGISTERED DESIGN

XM1021

140x140x155 mm

Cassaforma per laterizio / calcestruzzo con microregolazione per allineamento. **Gruppo di alimentazione da prevedere remoto esternamente alla cassaforma.**

Brick/concrete housing with micro-adjustment for alignment. **Electrical power supply must be remote outside of the housing.**

I prodotti sono venduti con alimentazione di serie GU10. Le elettrificazioni opzionali (XM2, XM5/GU10-50, XM5/350N, XM5/250 HO) e gli Optionals (XM6/350/15, XM6/250/10, XM6-20 D/P MULTI, XM6-25 D/P MULTI) sono forniti separatamente al prodotto e vanno perciò sostituiti a quelli di serie.

The products are sold with GU10 fittings. Different types of electricity supply (XM2, XM5/GU10-50, XM5/350N, XM5/250 HO) and the Optionals (XM6/350/15, XM6/250/10, XM6-20 D/P MULTI, XM6-25 D/P MULTI) substitute the series fitting.

- Minima altezza di ingombro dell'apparecchio (le quote minime del vano di incasso sono riportate sul foglio di istruzioni)

Minimum height of the appliance (see the minimum values for housing compartment in the instruction sheets)

- * Dimensione dell'alimentatore maggiore del foro d'incasso, dunque installare l'alimentatore in apposito vano d'ispezione.

Power supply unit is larger than the recess hole, install the power supply unit in a special inspection compartment.



Wall washer in gesso con LED Wall washer in plaster with LED

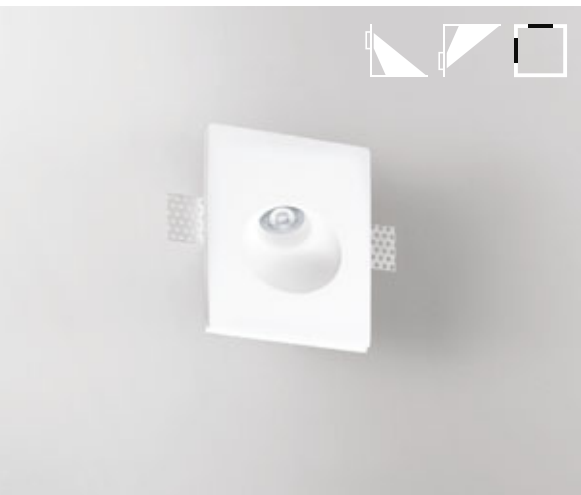

XGR1023

1W 350mA 2,85V 3000K Ra80 53,5lm
CE IP20

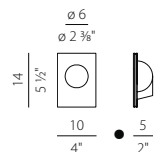

+ **Electric options**
(see details on page 518)

XM6/350/15 DRIVER ★
XM6-20 D/P MULTI DRIVER ★
XM6-25 D/P MULTI DRIVER ★

REGISTERED DESIGN

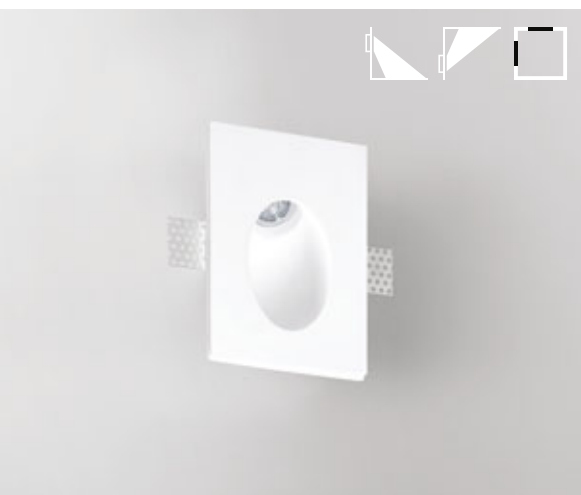

XGR1024

1W 350mA 2,85V 3000K Ra80 53,5lm
CE IP20

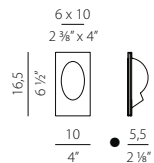

+ **Electric options**
(see details on page 518)

XM6/350/15 DRIVER ★
XM6-20 D/P MULTI DRIVER ★
XM6-25 D/P MULTI DRIVER ★

REGISTERED DESIGN

XM1023

149x108x60 mm

XM1024

173x108x60 mm

Cassaforma per laterizio / calcestruzzo con microregolazione per allineamento. **Gruppo di alimentazione da prevedere remoto esternamente alla cassaforma.**

Brick/concrete housing with micro-adjustment for alignment. **Electrical power supply must be remote outside of the housing.**

- Minima altezza di ingombro dell'apparecchio (le quote minime del vano di incasso sono riportate sul foglio di istruzioni)
- ★ Dimensione dell'alimentatore maggiore del foro d'incasso, dunque installare l'alimentatore in apposito vano d'ispezione.

Minimum height of the appliance (see the minimum values for housing compartment in the instruction sheets)

Power supply unit is larger than the recess hole, install the power supply unit in a special inspection compartment.



Wall washer in gesso con LED Wall washer in plaster with LED



XGQ1025

1W 350mA 2,85V 3000K Ra80 53,5lm
CE IP20

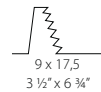
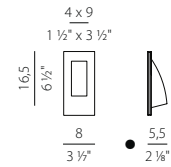

+ **Electric options**
(see details on page 518)

XM6/350/15 DRIVER ★
XM6-20 D/P MULTI DRIVER ★
XM6-25 D/P MULTI DRIVER ★

REGISTERED DESIGN

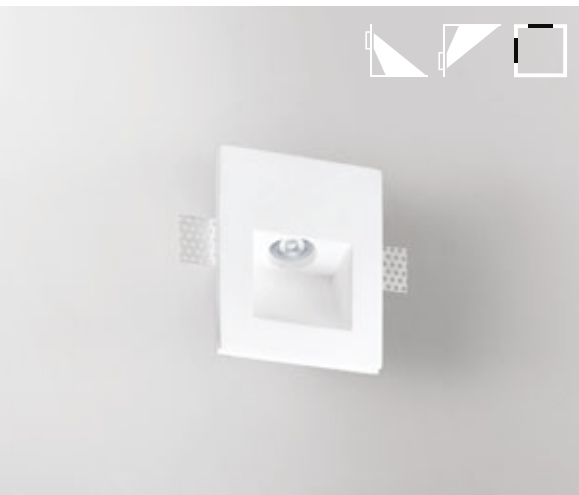

XGQ1026

1W 350mA 2,85V 3000K Ra80 53,5lm
CE IP20

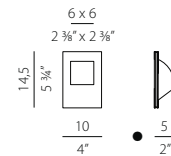

+ **Electric options**
(see details on page 518)

XM6/350/15 DRIVER ★
XM6-20 D/P MULTI DRIVER ★
XM6-25 D/P MULTI DRIVER ★

REGISTERED DESIGN

XM1025

171x90x60 mm

XM1026

149x108x60 mm

Cassaforma per laterizio / calcestruzzo con microregolazione per allineamento. **Gruppo di alimentazione da prevedere remoto esternamente alla cassaforma.**

Brick/concrete housing with micro-adjustment for alignment. **Electrical power supply must be remote outside of the housing.**

- Minima altezza di ingombro dell'apparecchio (le quote minime del vano di incasso sono riportate sul foglio di istruzioni)

Minimum height of the appliance (see the minimum values for housing compartment in the instruction sheets)

- * Dimensione dell'alimentatore maggiore del foro d'incasso, dunque installare l'alimentatore in apposito vano d'ispezione.

Power supply unit is larger than the recess hole, install the power supply unit in a special inspection compartment.

Incasso in gesso completo di faretto orientabile in metallo bianco Plaster recessed with adjustable metal white spot



Example of bulb

XGR1027

XM3 lampholder + terminal block

Max 50W GU10

CE IP20

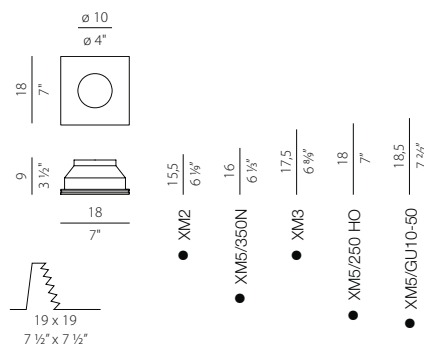

+ Electric options

(see details on page 518)

XM2 lampholder + terminal block

XM5/GU10-50 retrofit led lamp

XM5/350N LED

XM5/250 HO LED

XM6/350/15 DRIVER

XM6/250/10 DRIVER

XM6-20 D/P MULTI DRIVER *

XM6-25 D/P MULTI DRIVER



Incasso in gesso fisso con vetro / Fixed plaster recessed with Glass

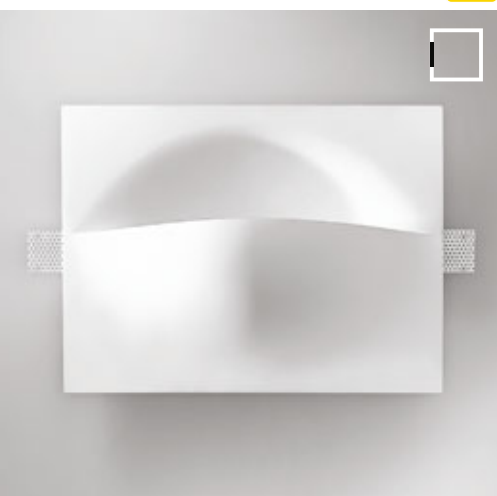

XGQ1031 LED

Potenza assorbita apparecchio

Luminaire power consumption 15W

Flusso luminoso apparecchio

Luminaire luminous flux 1281lm

3000K Ra80 220-240V

CE IP20

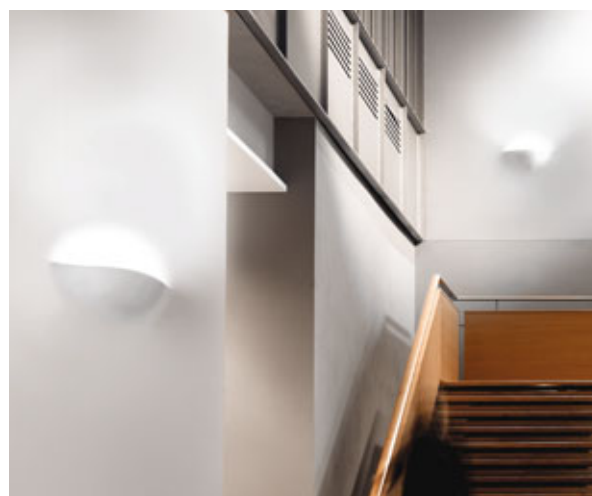
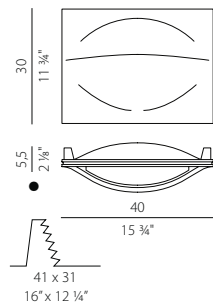

REGISTERED DESIGN

XM1027

185x185x190 mm

Cassaforma per laterizio / calcestruzzo con microregolazione per allineamento. **Gruppo di alimentazione da prevedere remoto esternamente alla cassaforma.**

Brick/concrete housing with micro-adjustment for alignment. **Electrical power supply must be remote outside of the housing.**

I prodotti sono venduti con alimentazione di serie GU10. Le elettrificazioni opzionali (XM2, XM5/GU10-50, XM5/350N, XM5/250 HO) e gli Optionals (XM6/350/15, XM6/250/10, XM6-20 D/P MULTI, XM6-25 D/P MULTI) sono forniti separatamente al prodotto e vanno perciò sostituiti a quelli di serie.

The products are sold with GU10 fittings. Different types of electricity supply (XM2, XM5/GU10-50, XM5/350N, XM5/250 HO) and the Optionals (XM6/350/15, XM6/250/10, XM6-20 D/P MULTI, XM6-25 D/P MULTI) substitute the series fitting.

* Dimensione dell'alimentatore maggiore del foro d'incasso, dunque installare l'alimentatore in apposito vano d'ispezione.

Power supply unit is larger than the recess hole, install the power supply unit in a special inspection compartment.

XM1031

410x315x72 mm

Cassaforma per laterizio /calcestruzzo con microregolazione per allineamento.

Brick/concrete housing with micro-adjustment for alignment.

● Minima altezza di ingombro dell'apparecchio (le quote minime del vano di incasso sono riportate sul foglio di istruzioni)

Minimum height of the appliance (see the minimum values for housing compartment in the instruction sheets)

Fotometrie e Classi Energetiche disponibili www.panzeri.it
Photometric data and Energy Label available at www.panzeri.it

**Incasso con cornice in gesso e faretto grigio metallizzato completamente orientabile.
Scatola interna nera o bianca.
Plaster frame recessed with metallized grey totally adjustable spot recessed.
White or black inner box.**



XGQ1034-1 WHI
XGQ1034-1 BLA
XGQ1034-1C WHI

Per inserimento in cassaforma
To be used in brick/concrete housing

XGQ1034-1C BLA

Per inserimento in cassaforma
To be used in brick/concrete housing

Max 75W G53 12V QR111

CE IP20

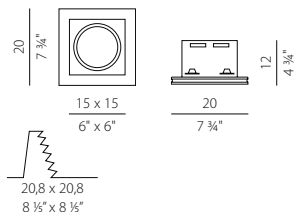

+ Electric options
(see details on page 518)

XM5/111AC
22,5W 3000K 40° Ra83 220-240V 1850lm
NOT DIMMABLE



REGISTERED DESIGN



XGQ1034-2 WHI
XGQ1034-2 BLA
XGQ1034-2C WHI

Per inserimento in cassaforma
To be used in brick/concrete housing

XGQ1034-2C BLA

Per inserimento in cassaforma
To be used in brick/concrete housing

2 x Max 75W G53 12V QR111

CE IP20

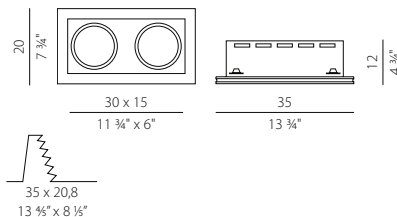

+ Electric options
(see details on page 518)

XM5/111AC
22,5W 3000K 40° Ra83 220-240V 1850lm
NOT DIMMABLE



REGISTERED DESIGN

XM1034-1
300x210x152 mm
XM1034-2
445x210x155 mm

Cassaforma per laterizio / calcestruzzo con microregolazione per allineamento. **Gruppo di alimentazione da prevedere remoto esternamente alla cassaforma.**

Brick/concrete housing with micro-adjustment for alignment. **Electrical power supply must be remote outside of the housing.**

I prodotti sono venduti con alimentazione di serie G53 (QR111). L'elettrificazione opzionale XM5/111AC è fornita separatamente al prodotto e va perciò sostituita a quella di serie.

The products are sold with G53 (QR111) fittings. XM5/111AC bulb is an optional and substitutes the series fitting.

Incasso con cornice in gesso e faretto grigio metallizzato completamente orientabile. Scatola interna nera o bianca. Plaster frame recessed with metallized grey totally adjustable spot recessed. White or black inner box.

XGQ1034-3 WHI
XGQ1034-3 BLA
XGQ1034-3C WHI
 Per inserimento in cassaforma
 To be used in brick/concrete housing
XGQ1034-3C BLA
 Per inserimento in cassaforma
 To be used in brick/concrete housing
 3 x Max 75W G53 12V QR111 
 CE IP20  

+ Electric options
 (see details on page 518)

XM5/111AC
 22,5W 3000K 40°
 Ra 83 220-240V 1850lm
 NOT DIMMABLE



REGISTERED DESIGN

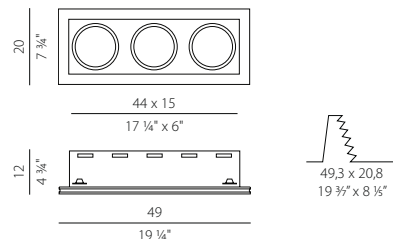

Example of bulb

▲ XGQ1032 LED

Potenza assorbita apparecchio
 Luminaire power consumption 13W
 Flusso luminoso apparecchio
 Luminaire luminous flux 911 lm
 3000K Ra 80 220-240V
 CE IP20

Incasso in gesso fisso con vetro
Fixed plaster recessed with Glass

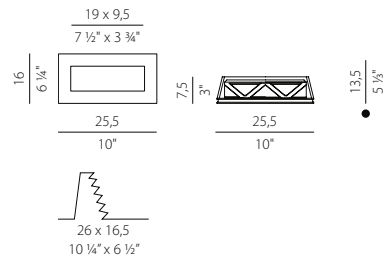

XM1034-3
 590x210x155 mm

Cassaforma per laterizio / calcestruzzo con microregolazione per allineamento. **Gruppo di alimentazione da prevedere remoto esternamente alla cassaforma.**

Brick/concrete housing with micro-adjustment for alignment. **Electrical power supply must be remote outside of the housing.**

I prodotti sono venduti con alimentazione di serie G53 (QR111). L'elettrificazione opzionale XM5/111AC è fornita separatamente al prodotto e va perciò sostituita a quella di serie.

The products are sold with G53 (QR111) fittings. XM5/111AC bulb is an optional and substitutes the series fitting.

- Minima altezza di ingombro dell'apparecchio (le quote minime del vano di incasso sono riportate sul foglio di istruzioni) Minimum height of the appliance (see the minimum values for housing compartment in the instruction sheets)
- Con struttura metallica. With metal frame.
- ▲ Elettrificazione solo per cartongesso. No cassaforma Electrification only for plasterboard. No housing

Fotometrie e Classi Energetiche disponibili www.panzeri.it
 Photometric data and Energy Label available at www.panzeri.it



Incasso in gesso fisso con vetro Fixed plaster recessed with Glass



XGQ1210 LED

Potenza assorbita apparecchio
Luminaire power consumption 15W
Flusso luminoso apparecchio
Luminaire luminous flux 1281lm
3000K Ra80 220-240V
C€ IP20

XGQ1210 LED DIM

Potenza assorbita apparecchio
Luminaire power consumption 15W
Flusso luminoso apparecchio
Luminaire luminous flux 1281lm
3000K Ra80 220-240V DALI / PUSH DIM
C€ IP20

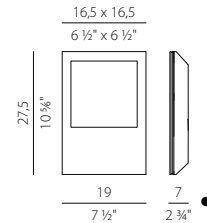

Foglia oro a richiesta
Gold leaf available on request

XM1210

325x195x75 mm

Cassaforma per laterizio / calcestruzzo con
microregolazione per allineamento.

Brick/concrete housing with micro-adjustment for
alignment.

- Minima altezza di ingombro dell'apparecchio (le quote minime del vano di incasso sono riportate sul foglio di istruzioni) Minimum height of the appliance (see the minimum values for housing compartment in the instruction sheets)

21	Foglia oro (a richiesta)	Gold leaf (available on request)
23	Foglia argento (a richiesta)	Silver leaf (available on request)
24	Foglia Rame (a richiesta)	Copper leaf (available on request)



Incasso in gesso fisso con vetro Fixed plaster recessed with Glass



XGQ1211 LED

Potenza assorbita apparecchio
Luminaire power consumption 15W
Flusso luminoso apparecchio
Luminaire luminous flux 1281lm
3000K Ra80 220-240V
CE IP20

XGQ1211 LED DIM

Potenza assorbita apparecchio
Luminaire power consumption 15W
Flusso luminoso apparecchio
Luminaire luminous flux 1281lm
3000K Ra80 220-240V DALI / PUSH DIM
CE IP20

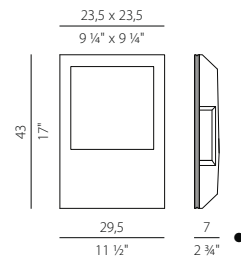

Foglia oro a richiesta
Gold leaf available on request

XM1211

439x300x74 mm

Cassaforma per laterizio / calcestruzzo con
microregolazione per allineamento.

Brick/concrete housing with micro-adjustment for
alignment.

- Minima altezza di ingombro dell'apparecchio (le quote minime del vano di incasso sono riportate sul foglio di istruzioni)

Minimum height of the appliance (see the minimum values for housing compartment in the instruction sheets)

21 Foglia oro (a richiesta)	Gold leaf (available on request)
23 Foglia argento (a richiesta)	Silver leaf (available on request)
24 Foglia Rame (a richiesta)	Copper leaf (available on request)

INCASSI

515 **JOE**
515 **JOE. Q**
516 **JOE TWIST**
513 **QUEENS IN 40**
512 **QUEENS IN 50 IP65**
511 **QUEENS IN 60**
514 **ROY**
514 **XSV2008**



Incasso rotondo in pressofusione di alluminio IP43 a dissipazione passiva con LED COB integrato in colore bianco, parte interna nera o bianca (senza accessori extra).

Possibilità di cilindro interno colore oro satinato a richiesta.

A richiesta ottiche con diversi fasci luminosi.

Round spotlight in die-cast aluminium IP43 with passive thermal dissipation equipped with integrated LED COB finished in black or white colour, black or white inside part (without extra optional). Available satin gold inside cylinder on request.

On request optics with different light beams.

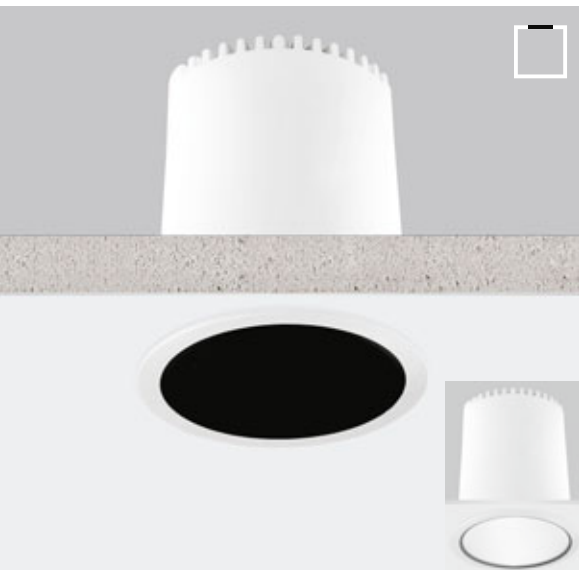

Queens In 60

XR26201.060.2515

LED 9W 250mA 3000K 38° Ra90
Flusso luminoso apparecchio
Luminaire luminous flux 632lm
LED 12W 350mA 3000K 38° Ra90
Flusso luminoso apparecchio
Luminaire luminous flux 852lm

XR26201.060.1715

LED 9W 250mA 2700K 38° Ra90
Flusso luminoso apparecchio
Luminaire luminous flux 616lm
LED 12W 350mA 2700K 38° Ra90
Flusso luminoso apparecchio
Luminaire luminous flux 830lm
CE IP43 IP20 IK08 850°

XMR9

Cilindro interno color oro satinato
Inside satin gold cylinder.

+ Electric options

(see details on page 518)

XM6-20 UNI DRIVER

XM6-20 D/P MULTI DRIVER

XM6-25 D/P MULTI DRIVER

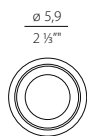

Protezione contro l'inversione di polarità
Reverse polarity protection

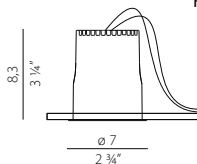

Accessori: ottiche intercambiabili / Replaceable optics accessories:

XMR5 21° Mirror metalized

XMR6 26° Mirror metalized

XMR7 38° Mirror metalized

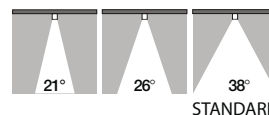

I Driver non sono inclusi, vedi electric options. Da acquistare separatamente.

Drivers not included, see electric options. Please purchase separately.



Incasso rotondo in pressofusione di alluminio IP65 a dissipazione passiva con LED COB integrato in colore bianco, parte interna nera o bianca (senza accessori extra).
Round spotlight in die-cast aluminium IP65 with passive thermal dissipation equipped with integrated LED COB finished in black or white colour, black or white inside part (without extra optional).

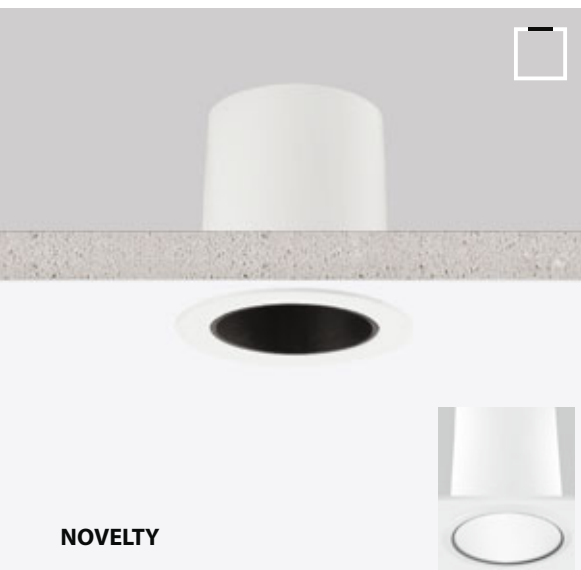

Queens In 50 IP65

XR22501.050.2515

LED 6,5W 700mA 3000K 34° Ra90
Flusso luminoso apparecchio
Luminaire luminous flux 455lm
CE IP65 ϕ 850°

+ Electric options
(see details on page 518)

XM6-20 UNI DRIVER ★

XM6-20 D/P MULTI DRIVER ★

XM6-25 D/P MULTI DRIVER ★

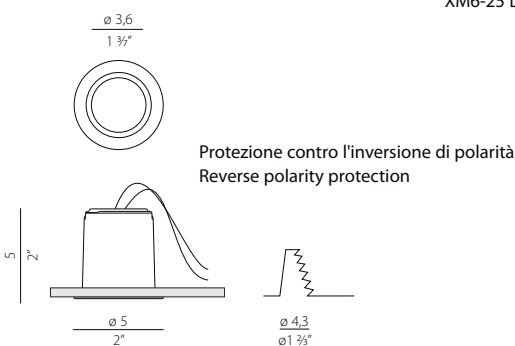

- I Driver non sono inclusi, vedi electric options. Da acquistare separatamente.

Drivers not included, see electric options. Please purchase separately.

- ★ Dimensione dell'alimentatore maggiore del foro d'incasso, dunque installare l'alimentatore in apposito vano d'ispezione.

Power supply unit is larger than the recess hole, install the power supply unit in a special inspection compartment.



Incasso rotondo in pressofusione di alluminio IP43 a dissipazione passiva con LED COB integrato in colore bianco, parte interna nera o bianca (senza accessori extra).
Round spotlight in die-cast aluminium IP43 with passive thermal dissipation equipped with integrated LED COB finished in white colour, black or white inside part (without extra optional).

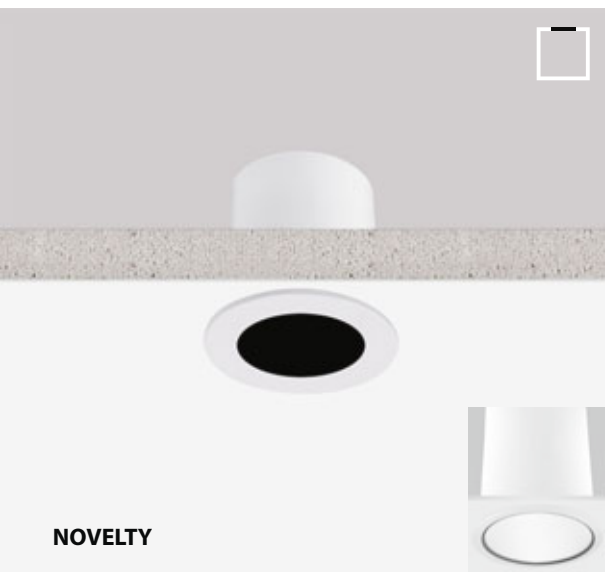

Queens In 40

XR25401.040.2615

LED 4,5W 500mA 3000K 60° Ra90
 Flusso luminoso LED
 LED luminous flux 500lm

CE IP43 IP20 \diamond IK07 850°

XR25401.040.1815

LED 4,5W 500mA 2700K 60° Ra90
 Flusso luminoso LED
 LED luminous flux 470lm

CE IP43 IP20 \diamond IK07 850°

+ Electric options

(see details on page 518)

XM6-20 UNI DRIVER ★

XM6-20 D/P MULTI DRIVER ★

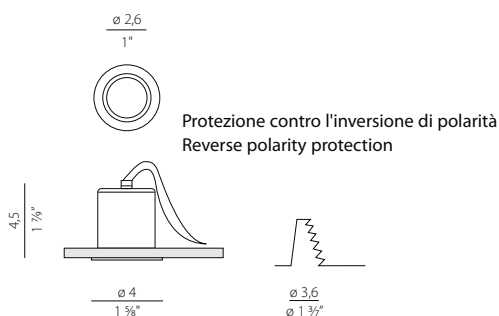

● I Driver non sono inclusi, vedi electric options. Da acquistare separatamente.

Drivers not included, see electric options. Please purchase separately.

★ Dimensione dell'alimentatore maggiore del foro d'incasso, dunque installare l'alimentatore in apposito vano d'ispezione.

Power supply unit is larger than the recess hole, install the power supply unit in a special inspection compartment.



Incasso rotondo in pressofusione di alluminio IP43 a dissipazione passiva con LED COB integrato in colore bianco e a richiesta ottiche con diversi fasci luminosi.
Round spotlight in die-cast aluminium IP43 with passive thermal dissipation equipped with integrated LED COB finished in white colour and on request optics with different light beams.

Roy

XR255-43-3K

LED 12W 350mA 3000K 55° Ra85
 Flusso luminoso apparecchio
 Luminaire luminous flux 1513lm

LED 18W 500mA 3000K 55° Ra85
 Flusso luminoso apparecchio
 Luminaire luminous flux 2092lm

XR255-43-4K

LED 12W 350mA 4000K 55° Ra85
 Flusso luminoso apparecchio
 Luminaire luminous flux 1602lm

LED 18W 500mA 4000K 55° Ra85
 Flusso luminoso apparecchio
 Luminaire luminous flux 2180lm
 CE IP43 IP20 IK08 850°

+ Electric options
 (see details on page 518)

XM6-20 UNI DRIVER
 XM6-20 D/P MULTI DRIVER
 XM6-25 D/P MULTI DRIVER

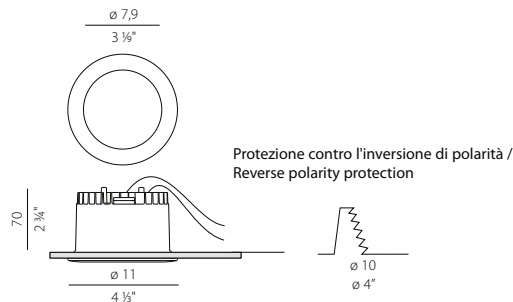

Accessori: ottiche intercambiabili / Replaceable optics accessories:

- XMR1** 18° Mirror metalized
- XMR2** 30° Mirror metalized
- XMR3** 55° Mirror metalized
- XMR4** 70° White

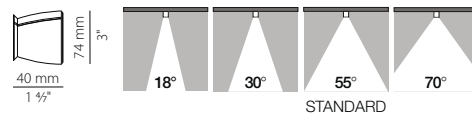

I Driver non sono inclusi, vedi electric options. Da acquistare separatamente.

Drivers not included, see electric options. Please purchase separately.



Incasso in vetro "senza viti" parzialmente acidato con bordo bianco
Partially frosted Glass "no screws" recessed, white frame

XSV2008 WHI

XM3 lampholder + terminal block
 Max 50W GU10
 CE IP20

+ Electric options
 (see details on page 518)

XM2 lampholder + terminal block
 XM5/GU10-50 retrofit led lamp
 XM5/350N LED
 XM5/250 HO LED
 XM6/350/15 DRIVER
 XM6/250/10 DRIVER
 XM6-20 D/P MULTI DRIVER
 XM6-25 D/P MULTI DRIVER

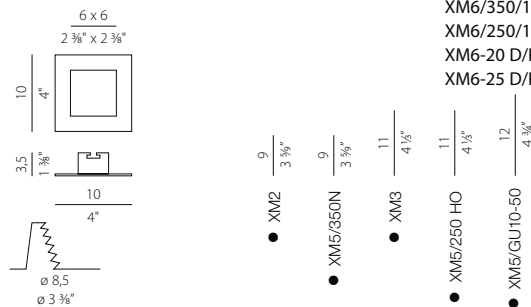

I prodotti sono venduti con alimentazione di serie GU10. Le elettrificazioni opzionali (XM2, XM5/GU10-50, XM5/350N, XM5/250 HO) e gli Optional (XM6/350/15, XM6/250/10, XM6-20 D/P MULTI, XM6-25 D/P MULTI) sono forniti separatamente al prodotto e vanno perciò sostituiti a quelli di serie.

The products are sold with GU10 fittings. Different types of electricity supply (XM2, XM5/GU10-50, XM5/350N, XM5/250 HO) and the Optionals (XM6/350/15, XM6/250/10, XM6-20 D/P MULTI, XM6-25 D/P MULTI) substitute the series fitting.

- Minima altezza di ingombro dell'apparecchio (le quote minime del vano di incasso sono riportate sul foglio di istruzioni)

Minimum height of the appliance (see the minimum values for housing compartment in the instruction sheets)

Enzo Panzeri 2011

Joe, Joe.Q faretto da incasso in alluminio, bianco o nero con o senza GU10 LED Spot
Joe recessed in white or black aluminium with or without GU10 LED Spot



JOE

XA2115
XA2115 BLA

XM3 lampholder + terminal block + Incl. LED BULB
 * 9W GU10 3000K 36° Ra80 840lm 110-240V

Not dimmable

ST.XA2115 (senza lampadina / without bulb)

CE IP20

HALO: Max 50W GU10

CE IP20

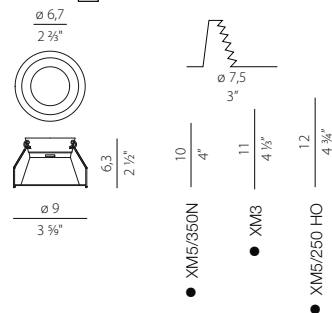

+ Electric options
 (see details on page 518)

XM5/350N LED
 XM5/250 HO LED
 XM6/350/15 DRIVER
 XM6/250/10 DRIVER
 XM6-20 D/P MULTI DRIVER
 XM6-25 D/P MULTI DRIVER



* Includa lampadina / Included bulb

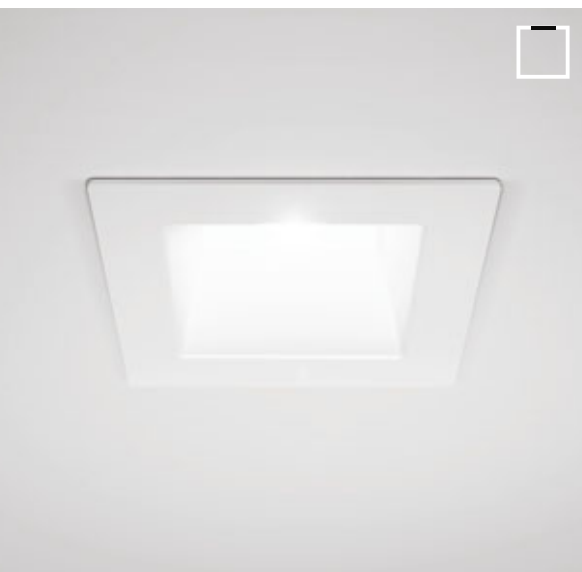

JOE.Q

XA2116
XA2116 BLA

XM3 lampholder + terminal block + Incl. LED BULB
 * 9W GU10 3000K 36° Ra80 840lm 110-240V

Not dimmable

ST.XA2116 (senza lampadina / without bulb)

CE IP20

HALO: Max 50W GU10

CE IP20

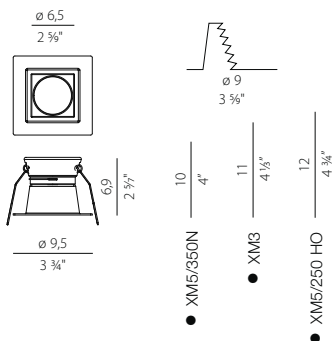

+ Electric options
 (see details on page 518)

XM5/350N LED
 XM5/250 HO LED
 XM6/350/15 DRIVER
 XM6/250/10 DRIVER
 XM6-20 D/P MULTI DRIVER
 XM6-25 D/P MULTI DRIVER



* Includa lampadina / Included bulb

• Minima altezza di ingombro dell'apparecchio (le quote minime del vano di incasso sono riportate sul foglio di istruzioni)

Minimum height of the appliance (see the minimum values for housing compartment in the instruction sheets)

Joe Twist faretto da incasso orientabile in alluminio, bianco con o senza GU10 LED Spot
Joe Twist recessed adjustable aluminium spotlight in white with or without GU10 LED Spot

JOE TWIST

XA2117

XM3 lampholder + terminal block + Incl. LED BULB

★ 9W GU10 3000K 36° Ra80 840lm 110-240V 

Not dimmable

ST.XA2117 (senza lampadina / without bulb)

CE IP20 

HALO: Max 50W GU10 

CE IP20 

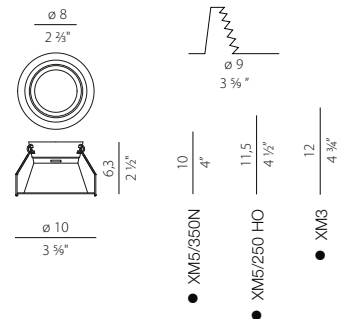

+ Electric options
(see details on page 518)

XM5/350N LED
 XM5/250 HO LED
 XM6/350/15 DRIVER
 XM6/250/10 DRIVER
 XM6-20 D/P MULTI DRIVER
 XM6-25 D/P MULTI DRIVER



★ Inclusa lampadina / Included bulb

● Minima altezza di ingombro dell'apparecchio (le quote minime del vano di incasso sono riportate sul foglio di istruzioni)

Minimum height of the appliance (see the minimum values for housing compartment in the instruction sheets)



Fotometrie e Classi Energetiche disponibili www.panzeri.it
 Photometric data and Energy Label available at www.panzeri.it

ELECTRIC OPTIONS

518 **ELECTRIC OPTIONS**

526 **TECHNICAL INFORMATION**

530 **FONDAMENTI DI ILLUMINOTECNICA / LIGHTING BASICS**

ELECTRIC OPTIONS

Componenti elettrici / Electrical components

XM2

LAMPHOLDER + TERMINAL BLOCK

MAX 50W GU5,3 12V 
 CE IP20  

XM3

LAMPHOLDER + TERMINAL BLOCK

MAX 50W GU10 
 OR GU10 FLUO 
 OR LED LAMP GU10 
 CE IP20  

XM3L

LAMPHOLDER

MAX 75W GU10 
 OR LED LAMP GU10 
 CE IP20  

LED Corrente costante / Constant current

XM5/350N

LED 6,1W 350mA 17,3V 3000K 35° Ra80
 Flusso luminoso apparecchio
 Luminaire luminous flux 725lm
 CE 

TECHNICAL INFORMATION	WIRING DIAGRAM 4
PAG. 526	PAG. 527

See matrix page 524

XM5/350N
 Ø 50mm H 65mm
 Ø 2" x 2 5/9"

XM5/250 HO
 Ø 50mm H 89mm
 Ø 2" x 3 1/2"

XM5/250 HO

LED 8,5W 250mA 34V 3000K 40° Ra95
 Flusso luminoso apparecchio
 Luminaire luminous flux 915lm
 CE 

TECHNICAL INFORMATION	WIRING DIAGRAM 4
PAG. 526	PAG. 527

See matrix page 524



LED tensione costante / Constant voltage

XM001.050.0110

Modulo / module 500 mm 28LED
8,5W 3000K Ra80 24V 1075lm
✂ 125mm **2150 lm/mt**
CE 

TECHNICAL INFORMATION	WIRING DIAGRAM 1
PAG. 526	PAG. 526

See matrix page 524

500 x 14 mm
19 3/8" x 5/8"



XM001.012.0110

Modulo / module 125 mm 7LED
2,1W 3000K Ra80 24V 268lm
2150 lm/mt
CE 

TECHNICAL INFORMATION	WIRING DIAGRAM 1
PAG. 526	PAG. 526

See matrix page 524

125 x 14 mm
5" x 5/8"



XM004.050.0110

Modulo / module 500 mm 35LED
12W 3000K Ra80 24V 1600lm
✂ 100mm **3200 lm/mt**
CE 

TECHNICAL INFORMATION	WIRING DIAGRAM 1
PAG. 526	PAG. 526

See matrix page 524

500 x 14 mm
19 3/8" x 5/8"



XM004.010.0110

Modulo / module 100 mm 7LED
2,4W 3000K Ra80 24V 320lm
3200 lm/mt
CE 

TECHNICAL INFORMATION	WIRING DIAGRAM 1
PAG. 526	PAG. 526

See matrix page 524

100 x 14 mm
2 5/8" x 5/8"



XM1ROW/N/5MT/4000K
XM1ROW/IP65/N/5MT/4000K

STRIP ROLL 1 ROW 5 MT 4000K Ra80 24V
✂ 100 mm
5 x 60 led/mt - 5 x 14,4W/mt
5 x **1080 lm/mt**
CE 

TECHNICAL INFORMATION	WIRING DIAGRAM 2
PAG. 526	PAG. 526

See matrix page 524

5000 x 10 mm
197" x 3/8"



XM1ROW/5MT/3000K
XM1ROW/5MT/4000K

STRIP ROLL 1 ROW 5 MT 3000/4000K Ra80 24V
✂ 50 mm
5 x 120 led/mt - 5 x 9,6W/mt
5 x **1100 lm/mt**
CE 

TECHNICAL INFORMATION	WIRING DIAGRAM 2
PAG. 526	PAG. 526

See matrix page 524

5000 x 8 mm
197" x 1/8"



XM1ROW HO/3MT

STRIP ROLL 1 ROW 3 MT 3000K Ra80 24V
✂ 35 mm
3 x 168 led/mt - 3 x 35W/mt
3 x **2833 lm/mt**
CE 

TECHNICAL INFORMATION	WIRING DIAGRAM 3
PAG. 526	PAG. 527

See matrix page 524

3000 x 8 mm
197" x 1/8"



XM1ROW HE/N/5MT/2700K
XM1ROW HE/N/5MT/3000K

STRIP ROLL 1 ROW 5 MT 2700K/3000K Ra80 24V
✂ 50 mm
5 x 120 led/mt - 5 x 24W/mt
5 x **2000 lm/mt**
CE 

TECHNICAL INFORMATION	WIRING DIAGRAM 2
PAG. 526	PAG. 526

See matrix page 524

5000 x 8 mm
197" x 1/8"



XM1ROW HF/5MT/2700K
XM1ROW HF/5MT/3000K
XM1ROW HF/5MT/4000K
AVAILABLE FROM 09/2019

STRIP ROLL 1 ROW 5 MT 2700K/3000/4000K Ra80 24V
✂ 42 mm
5 x 168 led/mt - 5 x 10W/mt
5 x **1200 lm/mt**
CE 

TECHNICAL INFORMATION	WIRING DIAGRAM 2
PAG. 526	PAG. 526

See matrix page 524

5000 x 8 mm
197" x 1/8"



XM1ROW HD/5MT
XM1ROW HD/5MT/2700K
XM1ROW HD/5MT/4000K

STRIP ROLL 1 ROW 5 MT 2700/3000/4000K Ra80 24V
✂ 42 mm
5 x 168 led/mt - 5 x 17W/mt
5 x **1964 lm/mt**
CE 

TECHNICAL INFORMATION	WIRING DIAGRAM 2
PAG. 526	PAG. 526

See matrix page 524

5000 x 10 mm
197" x 3/8"



XM1ROW SNAKE/5MT

STRIP ROLL 1 ROW 5 MT 3000K Ra80 24V
✂ 100 mm
5 x 60 led/mt - 5 x 14,4W/mt
5 x **1080 lm/mt**
CE 

TECHNICAL INFORMATION	WIRING DIAGRAM 2
PAG. 526	PAG. 526

See matrix page 524

5000 x 8 mm
197" x 1/8"



ELECTRIC OPTIONS

LED lamp 220-240V

XM5/111AC

LED 22,5W 3000K 40° Ra 83 220-240V 1850lm NOT DIMMABLE



XM5/GU10-50

9W GU10 Ø 50 mm 3000K Ra80 840lm 110-240V NOT DIMMABLE



**XM5/GU10-35
NOVELTY**

4W GU10 Ø 35 mm 3000K Ra80 330lm 110-240V NOT DIMMABLE



**XM5/G9LED
NOVELTY**

4W G9 3000K Ra80 330lm 110-240V NOT DIMMABLE



LED driver corrente costante / Constant current

XM6-20 UNI

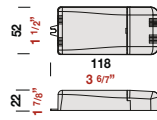

V in 220-240V AC
 V out 2-54V DC
 I out 250-700mA
 W 4-20
 λ 0,95

CE SELV
 See matrix page 524

**XM6/350/15
 NOVELTY**

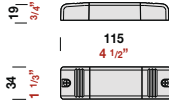

V in 100-240V AC
 V out 2-41V DC
 I out 350mA
 W 15
 λ 0,54

CE SELV
 See matrix page 524

XM6/250/10

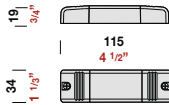

V in 100-240V AC
 V out 2-42V DC
 I out 250mA
 W 10
 λ ≥ 0,52

CE SELV
 See matrix page 524

LED Driver Multi-Corrente / Multi-dim (1-10V-DALI-PUSH DIM)

XM6-20 D/P MULTI

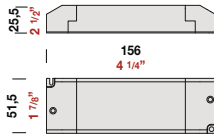

V in 220-240V AC
 V out 3-46V DC
 I out 200-900mA
 W 9,2-20,4
 λ ≥ 0,95

CE SELV 1...10V PUSH DIM DALI
 See matrix page 524

XM6-25 D/P MULTI

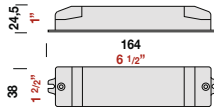

V in 220-240V AC
 V out 2,5-56V DC
 I out 150-900mA
 W 8,4-25,6
 λ ≥ 0,92

CE SELV PUSH DIM DALI
 See matrix page 524

ELECTRIC OPTIONS

LED Driver tensione costante / Constant voltage

XM30/24E

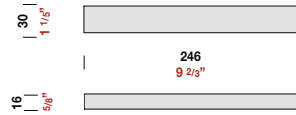

V in 220-240V AC
 V out 24V DC
 I out 1,25A DC
 W 30
 $\lambda \geq 0,9$
 CE SELV
 See matrix page 524

XM60/24E

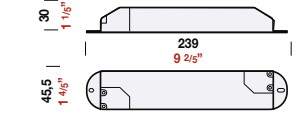

V in 220-240V AC
 V out 24V DC
 I out 2,5A DC
 W 60
 $\lambda \geq 0,9$
 CE SELV
 See matrix page 524

XMT70/24EN

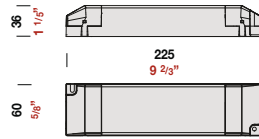

V in 220-240V AC
 V out 24V DC
 I out 2,9A DC
 W 70
 $\lambda \geq 0,97$
 CE SELV
 See matrix page 524

XM150/24E

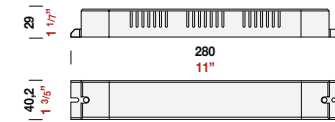

V in 220-240V AC
 V out 24V DC
 I out 6,25A DC
 W 150
 $\lambda \geq 0,96$
 CE SELV
 See matrix page 524

XM200/24E
NOVELTY

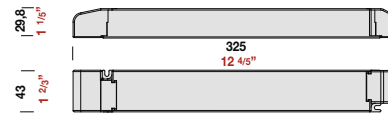

V in 220-240V AC
 V out 24V DC
 I out 8,33A DC
 W 200
 $\lambda 0,98$
 CE SELV
 See matrix page 524

XM35/24 DIM

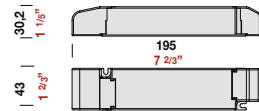

V in 220-240V AC
 V out 24V DC
 I out 1,453A DC
 W 35
 $\lambda 0,98$
 CE SELV PUSH DIM DALI
 See matrix page 524

XM60/24 DIM

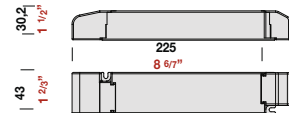

V in 220-240V AC
 V out 24V DC
 I out 2,50A DC
 W 60
 $\lambda 0,98$
 CE SELV PUSH DIM DALI
 See matrix page 524

XM100/24 DIM

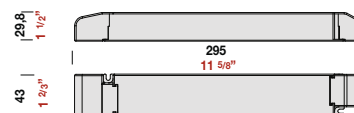

V in 220-240V AC
 V out 24V DC
 I out 4,167A DC
 W 100
 $\lambda 0,99$
 CE SELV PUSH DIM DALI
 See matrix page 524

XM150/24 DIM

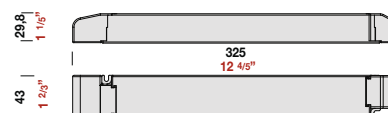

V in 220-240V AC
 V out 24V DC
 I out 6,250A DC
 W 150
 $\lambda 0,99$
 CE SELV PUSH DIM DALI
 See matrix page 524

LED control system

Dispositivi per la dimmerazione di moduli LED a 12-24VDC. Utilizzabili con alimentatore standard (non dimmerabile). E' possibile applicarli anche in impianti esistenti senza sostituire gli alimentatori presenti.

Dimming devices for LED modules (12-24VDC). Can be used with standard drivers (not dimmable). It's also possible to use the device in existing lighting systems without replacing the already installed LED drivers.

XM13/24D

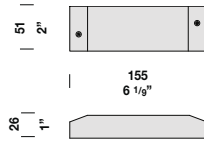

DISPOSITIVO DIMMERABILE
MODALITÀ DI DIMMERAZIONE
DIMMING DEVICE
DIMMING MODE
1-10V, PUSH DIM, DALI
V in 12-24V DC
I out 12A (MAX)DC
W 288(24V)/144(12V)

TECHNICAL INFORMATION	WIRING DIAGRAM
PAG. 526	PAG. 528

CE  SELV 1..10V PUSH DIM DALI
See matrix page 524

XM13/24D MINI

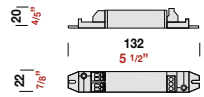

DISPOSITIVO DIMMERABILE
MODALITÀ DI DIMMERAZIONE
DIMMING DEVICE
DIMMING MODE
1-10V, PUSH DIM, DALI
V in 12-24V DC
I out 5A (MAX)DC
W 120(24V)/60(12V)

TECHNICAL INFORMATION	WIRING DIAGRAM
PAG. 526	PAG. 529

CE  SELV 1..10V PUSH DIM DALI
See matrix page 524

XM13/24A

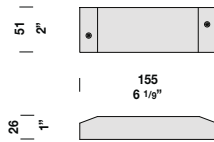

AMPLIFICATORE PER DISPOSITIVO
DIMMERAZIONE
PVM AMPLIFIER FOR
DIMMABLE DEVICE
SLAVE
V in 12-24V DC
I out 12A (MAX)DC
W 288(24V)/144(12V)

TECHNICAL INFORMATION	WIRING DIAGRAM
PAG. 526	PAG. 528

CE  SELV
See matrix page 524

ELECTRIC OPTIONS

MATRICE DI COMPATIBILITÀ LED/DRIVER - LED/DRIVER MATRIX

Constant current						
	XM5/350N	XM5/250 HO	XM001.050.0110	XM001.012.0110	XM004.050.0110	XM004.010.0110
XM6/250/10		1				
XM6/350/15	1					
XM6-25 D/P MULTI	min.1 - max.2	1				
XM6-20 D/P MULTI	min.1 - max.2	1				

Constant voltage						
			W	W	W	W
XM200/24E			200	200	200	200
XM150/24E			150	150	150	150
XM60/24E			60	60	60	60
XM30/24E			30	30	30	30
XM35/24 DIM			35	35	35	35
XM60/24 DIM			60	60	60	60
XM100/24 DIM			100	100	100	100
XM150/24 DIM			150	150	150	150

Led control systems						
XM13/24D			288	288	288	288
XM13/24A			288	288	288	288
XM13/24D MINI			120	120	120	120

MATRICE DI COMPATIBILITÀ LED/PROFILI - LED/PROFILE MATRIX

	XM001.050.0110	XM001.012.0110	XM004.050.0110	XM004.010.0110
XG2033				
XP2033				
XG2034				
XG2045				
XG2047				
XP2048				
XG2044				

<i>new</i>					
XM1ROW/5MT	XM1ROW N/5MT	XM1ROW HD/5MT	XM1ROW HE/N/5MT	XM1ROW HF/5MT	XM1ROW HO/3MT

W	W	W	W	W	W
200	200	200	200	200	200
150	150	150	150	150	150
60	60	60	60	60	60
30	30	30	30	30	30
35	35	35	35	35	35
60	60	60	60	60	60
100	100	100	100	100	100
150	150	150	150	150	150

288	288	288	288	288	288
288	288	288	288	288	288
120	120	120	120	120	120

<i>new</i>					
XM1ROW/5MT	XM1ROW N/5MT	XM1ROW HD/5MT	XM1ROW HE/N/5MT	XM1ROW HF/5MT	XM1ROW HO/3MT

TECHNICAL INFORMATION

APPARECCHI CON LED A TENSIONE COSTANTE 24V DC

Le nostre strip LED sono state studiate per essere installate all'interno dei nostri prodotti, pertanto se installate al di fuori dei nostri apparecchi è necessario dissipare in modo adeguato. Il collegamento tra i vari apparecchi/LED deve essere effettuato in parallelo. Si deve calcolare la potenza complessiva dei LED e aggiungere almeno 10%. Di conseguenza procedere nella scelta dell'alimentatore. E' necessario considerare la distanza tra alimentatori e apparecchi/LED per limitare possibili cadute di tensione. Segue la tabella 1 che indica la lunghezza/ sezione del cavo e la potenza con alimentazione a 24V DC. Viene indicata la distanza massima tra alimentatore e apparecchi/LED.

FIXTURES USING LEDS WITH A CONSTANT VOLTAGE OF 24V DC

Our LED strips are designed to be installed in our products so if installed elsewhere please consider thermal management by using proper heatsinks. The connection between the various fixtures / LEDs must be carried out in parallel. The total power of the LEDs must be calculated (+ at least 10%) in order to choose the correct power supply. The distance between power supplies and fixtures / LED must be considered to limit possible voltage drop. Table 1 (below) indicates the length / section of the cable and the output (W) using a 24V DC power supply. It shows the maximum distance between the power supply and the fixture/LED.

TABELLA 1			
W	1 mm ²	1,5 mm ²	2,5 mm ²
10	56 mt	85 mt	141 mt
20	28 mt	42 mt	71 mt
30	19 mt	28 mt	47 mt
40	14 mt	21 mt	35 mt
50	11 mt	17 mt	28 mt
60	9 mt	14 mt	24 mt
70	8 mt	12 mt	20 mt
80	7 mt	11 mt	18 mt
90	6 mt	9 mt	16 mt
100	6 mt	8 mt	14 mt
110	5 mt	8 mt	13 mt
120	5 mt	7 mt	12 mt
130	4 mt	7 mt	11 mt
140	4 mt	6 mt	10 mt
150	4 mt	6 mt	9 mt

WIRING DIAGRAM NR. 1

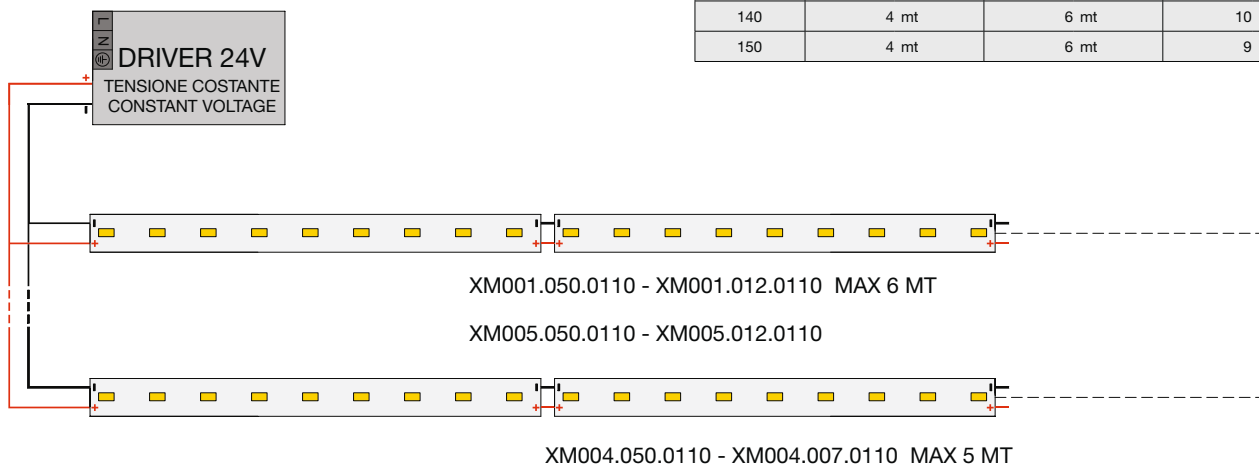

WIRING DIAGRAM NR. 2

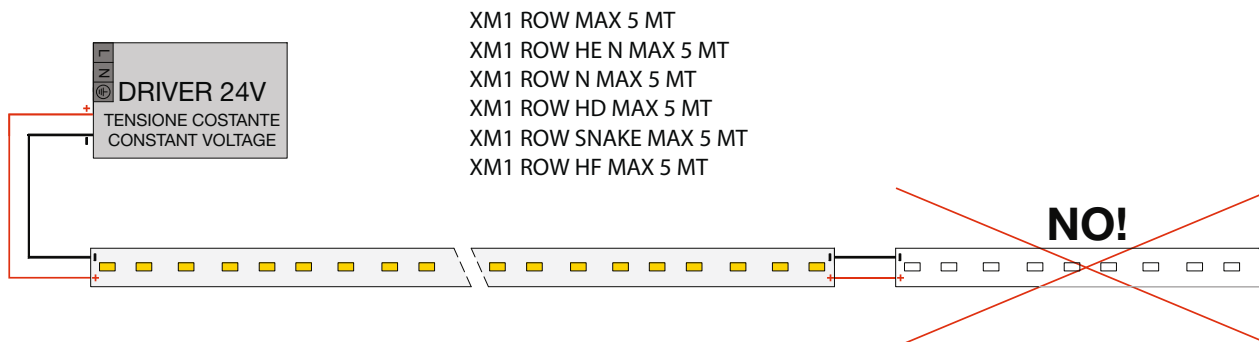

WIRING DIAGRAM NR. 3

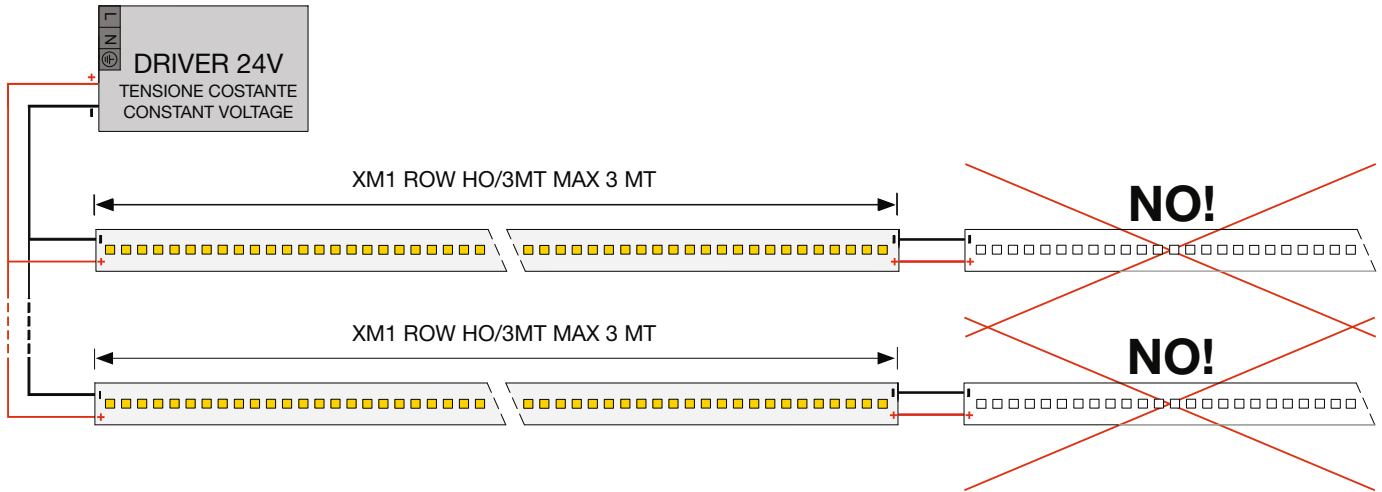

APPARECCHI CON LED A CORRENTE COSTANTE

Il collegamento tra i vari apparecchi/led deve essere effettuato in serie. Il numero di LED per alimentatore dipende dalla potenza e dalla tensione che l'alimentatore rende disponibile. Nonostante l'utilizzo di correnti molto basse è opportuno considerare la distanza tra alimentatori e apparecchi/LED. Segue la tabella 2 che indica la lunghezza/sezione del cavo con alimentatore a corrente costante. Viene indicata la distanza massima tra alimentatore e apparecchi/LED.

FIXTURES USING LEDS WITH A CONSTANT CURRENT

The connection between the various fixtures / LEDs must be carried out in series. The number of LEDs per power supply unit depends on the available power and voltage of the unit. Notwithstanding the use of very low currents, it is advisable to take into consideration the distance between ballasts and fixtures / LEDs. Table 2 (below) indicates the length / section of the cable using a constant current supply. It shows the maximum distance between the power supply and the fixture/LED.

TABELLA 2			
Sezione	1 mm ²	1,5 mm ²	2,5 mm ²
Lunghezza	20 mt	30 mt	50 mt

WIRING DIAGRAM NR. 4

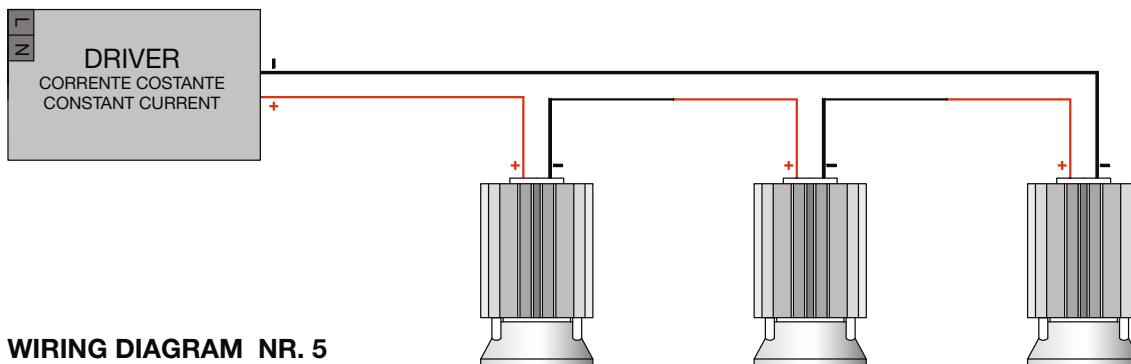

WIRING DIAGRAM NR. 5

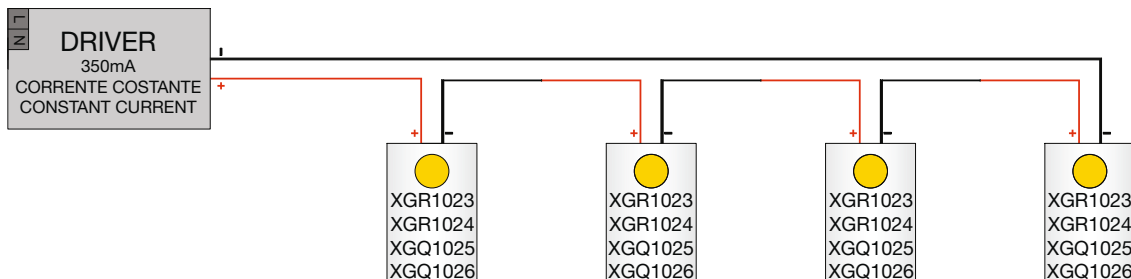

TECHNICAL INFORMATION

WIRING DIAGRAM N°6 XM13/24D - XM13/24A

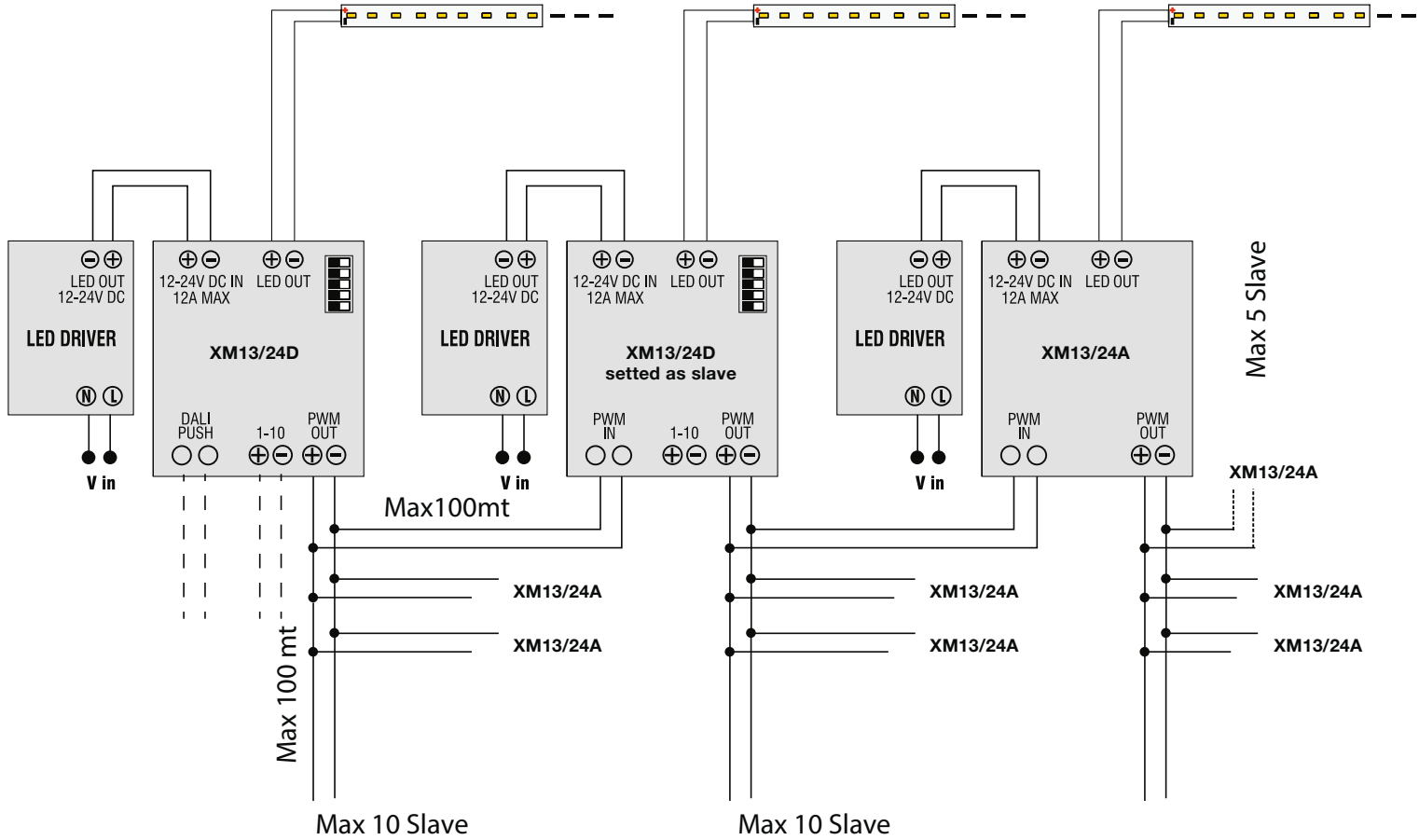

**WIRING DIAGRAM N°7
XM13/24D MINI**

Wiring diagram DALI

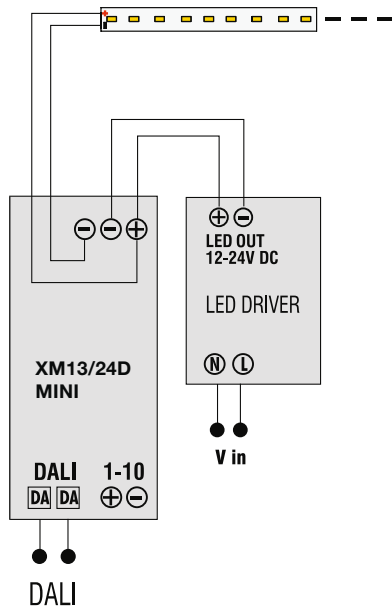

Wiring diagram Push

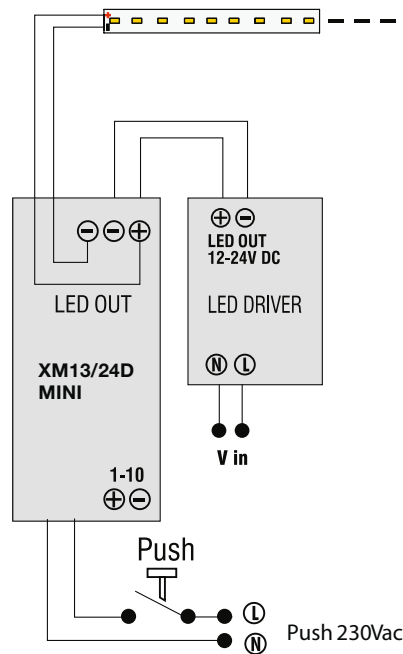

Wiring diagram Trimmer 1/10V

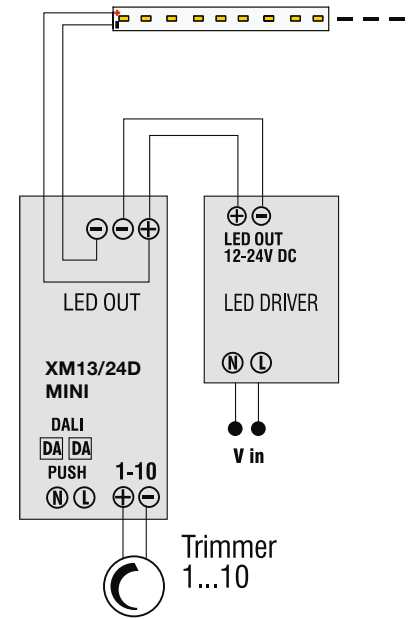

FLUSSO LUMINOSO Φ

Unità di misura: lumen (lm)

Per flusso luminoso si intende l'intera potenza irradiata dalla sorgente luce che viene valutata con la sensibilità spettrale dell'occhio. Il flusso luminoso è una grandezza molto utile per confrontare le lampade tradizionali con i LED.

LUMINOUS FLUX Φ

Unit: lumen (lm)

Luminous flux means the total power radiated by a light source, which is evaluated considering the spectral sensitivity of the eye. The luminous flux is a measurement very useful when comparing traditional lamps with LEDs.

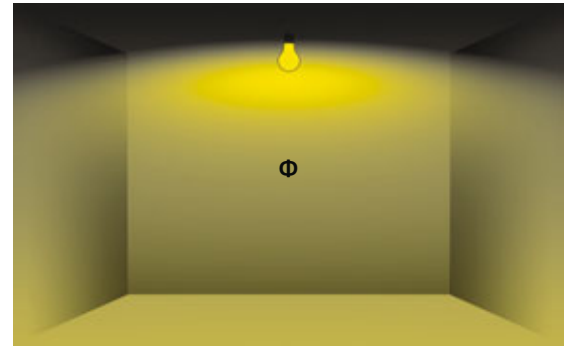

INTENSITÀ LUMINOSA I

Unità di misura: candela (cd)

Una sorgente luminosa irradia il suo flusso luminoso generalmente in diverse direzioni con diversa intensità. L'intensità della luce irradiata in una determinata direzione viene definita intensità luminosa.

LUMINOUS INTENSITY I

Unit: candela (cd)

A light source emits its luminous flux usually in different directions and at different intensities. The intensity of light radiated in a given direction is defined as light intensity.

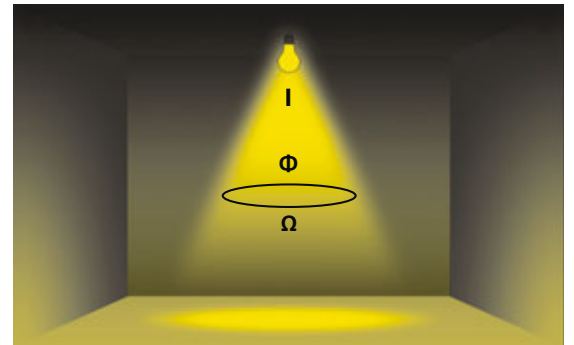

ILLUMINAMENTO E

Unità di misura: lux (lx)

L'illuminamento è dato dal rapporto tra il flusso luminoso irradiato e la superficie illuminata. L'illuminamento prodotto da un flusso luminoso di 1 lm che cade in modo uniforme su una superficie di 1 mq è pari a 1 lx.

ILLUMINANCE E

Unit: lux (lx)

Illuminance is the ratio of the luminous flux and the illuminated surface. The illumination produced by a luminous flux of 1 lm that falls evenly on a surface of 1 square meter is equal to 1 lx.

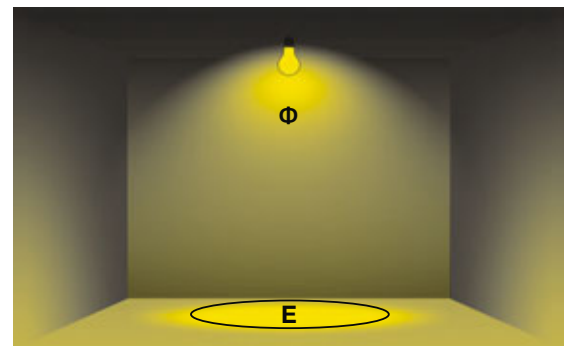

LUMINANZA L

Unità di misura: candela per metro quadrato [cd/m²]

La luminanza L di una sorgente di luce o di una superficie illuminata è determinante per la sensazione di luce percepita.

LUMINANCE L

Unit: candela per square meter [cd/m²]

The luminance L of a light source or an illuminated surface indicates how much luminous power will be detected by an eye looking at the surface from a particular angle of view.

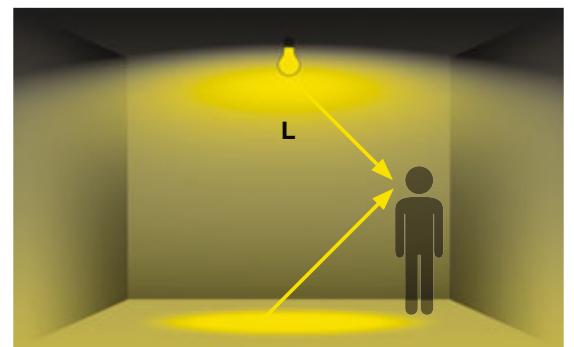

L'EFFICIENZA LUMINOSA

Unità di misura: lumen per watt (lm/W)

L'efficienza luminosa indica il rendimento di una lampada.

Viene espressa dal rapporto fra il flusso luminoso prodotto in lumen e la potenza applicata in watt.

LUMINOUS EFFICACY

Unit: lumens per watt (lm/W)

Luminous efficacy indicates the efficiency of a lamp.

It is the ratio between the luminous flux in lumens produced and the applied power in watts.

TEMPERATURA DI COLORE

Unità di misura: kelvin (K)

Temperatura di colore indica la tonalità della luce. Più è alto il valore e più fredda è la tonalità della luce

3000K - tonalità calda

4000K - tonalità neutra

5500K - tonalità diurna

COLOUR TEMPERATURE

Unit: kelvin (K)

Colour temperature indicates a light's tonality: the higher the value, the colder the tone of the light

3000K - warm tone

4000K - neutral tone

5500K - daylight tone

INDICE DI RESA CROMATICA

Ra oppure in inglese Color Rendering Index (CRI)

Si indica come resa cromatica la qualità della riproduzione dei colori sotto una certa illuminazione.

L'indice massimo di 100 rappresenta la resa cromatica ideale.

COLOR RENDERING INDEX

Ra or Color Rendering Index (CRI)

Ra is a quantitative measure of the ability of a light source to reproduce the colors of various objects faithfully in comparison with an ideal or natural light source.

The Ra maximum value 100 equals ideal color rendering.

MARCHI / MARKS



Prodotto conforme alle norme di sicurezza e alle direttive europee vigenti.
Product complying with safety rules and EU directives



Apparecchio in classe II
Apparecchio nel quale la protezione contro la scossa elettrica non si basa unicamente sull'isolamento fondamentale, ma anche sulle misure supplementari di sicurezza costituite dal doppio isolamento o dall'isolamento rinforzato. Queste misure non comportano dispositivi per la messa a terra e non dipendono dalle condizioni di installazione.
Class II Fixture
A fixture for which protection against an electric shock does not rely only on basic insulation but also offers further safety measures, such as double insulation or reinforced insulation.
These measures do not require grounding devices and are not dependent upon installation conditions.



Apparecchio in classe III
Apparecchio in cui la protezione contro la scossa elettrica si basa sull'alimentazione a bassissima tensione di sicurezza e in cui non si generano tensioni superiori alla stessa.
Nota: un apparecchio in classe III non deve essere provvisto di messa a terra.
Class III Fixture
A fixture in which protection against an electric shock is guaranteed by the extremely low and safe voltage level of the power supply, which does not generate higher voltage levels. NB: a Class III fixture does not require grounding protection.

IP..

Grado di protezione
Il grado di protezione degli apparecchi di illuminazione viene indicato con la sigla "IP" seguita da due cifre caratteristiche.
- la prima indica la protezione contro la penetrazione dei corpi solidi e della polvere
- la seconda indica la protezione contro la penetrazione dei liquidi
Protection Index
The protection rating of the lighting appliances is shown by the letters "IP" followed by two characteristic digits
- the first of these two digits indicates the degree of protection that the appliances offer against the entry of solid foreign objects
- the second one indicates the protection against the entry of water

IK..

Grado di protezione degli involucri per apparecchiature elettriche contro impatti meccanici esterni (codice IK)
Degree of protection provided by enclosures for electrical equipment against external mechanical impacts (IK code)



Lampadina protetta contro esplosioni
Lamp protected against explosion

RoHS

RoHS - DIRETTIVA 2002/95/CE (Restriction of the use of certain Hazardous Substances in electrical and electronic equipment) Direttiva europea che limiti l'utilizzo di alcune sostanze pericolose (piombo, cadmio, mercurio, cromo esavalente, bifenile polibromurati, Eteri difendi polibromurati). A partire da 1 luglio 2006 tali sostanze non possono essere più impiegate nei prodotti elettrici ed elettronici, salvo deroghe su alcune applicazioni.
RoHS - DIRECTIVE 2002/95/CE (Restriction of the use of certain Hazardous Substances in electrical and electronic equipment). The European Directive restricts the use of some dangerous substances: lead, mercury, cadmium, hexavalent chromium, polybrominated biphenyls (PBB) or polybrominated diphenyl ethers (PBDE). From 1st July 2006 such substances shall not be used anymore in electrical and electronic equipment apart from exceptions on specific applications.



Marchio unico di certificazione EAC (EurAsian Certification) che sostituisce i marchi nazionali GOST (R per la Russia, B per Bielorussia e K per Kazakistan)
Unique brand of EAC certification (Eurasian Certification) which replaces the national GOST brands (R for Russia, B for Belarus and K for Kazakhstan).

SELV

Bassissima tensione di sicurezza
Safety Extra Low Voltage

1-10V

Dimmer analogico con segnale di tensione continua 1-10V
Analogic dimmer with a direct voltage signal



Dimmer a taglio di fase ascendente/discendente (TRIAC)
Phase cutting dimmer leading edge, trailing edge (TRIAC)

DALI

Dimmer digitale con interfaccia DALI
Digital dimmer with DALI interface

DALI / PUSH DIM

Dimmer con funzionalità DALI o pulsante normalmente aperto NA
Dimmer for DALI protocol or push button application

PUSH DIM

Dimmer con pulsante normalmente aperto NA
Dimmer with push button NO

STEP DIM

Step Dim: accensione massima + 3 livelli di dimmerazione + spegnimento tramite sensore touch.
Step Dim: max on + 3 dimming levels + off through touch sensor.



Alimentatore idoneo al montaggio indipendente
Independent driver can be mounted separately outside a luminaire

1H/12H EMERGENCY

Emergenza integrata. Autonomia 1h / Tempo di ricarica 12h
Integrated emergency. Duration 1h/Recharging time 12h

850°

Prova del filo incandescente a 850°C.
Glow wire test at 850° degree.

CONSORZIO PER LA RACCOLTA E LO SMALTIMENTO DELLE APPARECCHIATURE DI ILLUMINAZIONE

PANZERI CARLO SRL ADERISCE AL CONSORZIO ECOLIGHT – MILANO ITALY

WEEE - DIRETTIVA 2002/96/CE, 2003/108/CE (WASTE ELECTRICAL AND ELECTRONIC EQUIPMENT) RIFIUTI DI APPARECCHI ELETTRICI ED ELETTRONICI.

La direttiva valida su tutto il territorio dell'Unione Europea definisce una serie di misure allo scopo di prevenire la produzione di rifiuti di apparecchiature elettriche ed elettroniche; di promuovere il riuso, il riciclo ed altre forme di recupero di tali tipologie di rifiuti; di limitare i rischi di impatto sull'ambiente derivanti dal trattamento e dallo smaltimento dei rifiuti in questione; di armonizzare le misure nazionali di gestione dei rifiuti elettrici ed elettronici.

Gli apparecchi di illuminazione marcati con l'apposito simbolo del cassonetto barrato  sono soggetti a raccolta differenziata separata dal resto dei rifiuti urbani.

Per la restituzione di un dispositivo dimesso, occorre servirsi dei sistemi di restituzione e di raccolta messi a disposizione nei singoli paesi di utilizzo.

PANZERI CARLO SRL JOINS CONSORZIO ECOLIGHT – MILANO ITALY

WEEE - DIRECTIVE 2002/96/CE, 2003/108/CE (WASTE ELECTRICAL AND ELECTRONIC EQUIPMENT).

The European Directive is applicable throughout the European Union and determines the measures in order to prevent the production of waste electrical and electronic equipment; to promote the re-use, the recycle and other forms of reutilization of these kind of waste; to restrict the risks of impact to the environment coming from treatment and disposal of these equipments; to harmonize national measures of managing waste electrical and electronic equipment.

Equipment marked with proper symbol of crossed container  may not be disposed of with household rubbish.

To return the used device, the return and collection systems available in every single Country must be used.



ADERENTE AD ASSOLOMBARDA
CONFINDUSTRIA MILANO MONZA E BRIANZA



Riconoscimento attribuito per oltre 50 anni di attività
Ricognition given for over 50 years of continuous activity



ADIMEMBER

ADI ASSOCIAZIONE PER IL DISEGNO INDUSTRIALE

Pur mantenendo inalterate le proprie caratteristiche di base, i nostri articoli possono risultare parzialmente modificati rispetto a come sono raffigurati nel presente catalogo. Ciò è dovuto all'evoluzione a cui sottoponiamo i prodotti, con lo scopo di un miglioramento continuo. Anche i colori presentati nel catalogo sono da considerarsi puramente indicativi.
While maintaining the basic characteristics of the product, the Company reserves the right to make modifications at any time with the sole aim of improvement. The colours illustrated in the catalogue are intended only as examples.

PANZERI®

PANZERI CARLO S.R.L.
Via Padania, 8 - 20853
Blassono MB - Italy
Sede Legale: Via Mameli, 11
20851 Lissone MB - Italy
T +39 039 2497483
F +39 039 2497396
panzeri@panzeri.it
export@panzeri.it
www.panzeri.it



PANZERI.IT